



DENTELO SURGICAL[®] INTERNATIONAL

Serving World of Surgical Since 1996.

25 YEARS
EXCELLENCE



SURGICAL Instruments Catalogue



www.dentelosurgical.com



Company Profile

DENVELO SURGICAL INTERNATIONAL has been manufacturing and supplying the Dental instruments, Dental Implant instruments, Surgical and other Medical instruments all over the world since 1996.

ADDITIONALLY

For more than 25 years, **DENVELO SURGICAL INTERNATIONAL** customers have been benefitting from our outstanding industry knowledge and our ability to provide high-quality dental and surgical instruments. We bring years of industry experience to each customer and constantly strives to meet our goal of 100% customer satisfaction. We believe in perfection, so all the instruments which we manufacture are sent to different well-reputed Surgeons worldwide. These surgeons test instruments in their clinics and their suggestions are seriously considered to make certain improvements in instruments.

DENVELO SURGICAL INTERNATIONAL always provide our customers with a quote on instruments as per their required specifications. We not only dispatch customer's order within the agreed time but also facilitate our regular customers to meet their urgent orders by maintaining stock for selective regular instruments in our warehouses and factory. Sample orders are accepted from Potential customers, so they can evaluate the quality of our instruments before they place bulk orders. Being a manufacturer, our prices are very competitive & affordable for all type of customers. Regarding Packaging & marking of instruments, we offer branded services to all customers and provide their brand mark or their company logo on products.

DENVELO SURGICAL INTERNATIONAL
C.E.O.

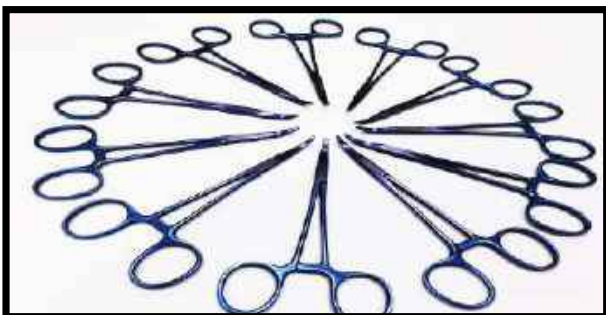



Content

01	<i>Diagnostic, Anaesthesia, Scalpels & knives</i>	7 - 28
02	<i>Scissors</i>	30 - 58
03	<i>Forceps, Clamps</i>	59 - 102
04	<i>Needle Holders, Micro Needle Holders</i>	103-108
05	<i>Suture Instruments, Needles, Probes, Applicators, Pocket Instruments Set.</i>	109-121
06	<i>Hooks, Retractors, Spatulas, Spreaders, Abdominal Retractors</i>	123-175
07	<i>Forceps, Intestinal Clamps, Specula, Biopsy Forceps, Anusscopes</i>	176-201
08	<i>Gall Duct Forceps / Probes / Scissors / Kidney Forceps, Urinary Instruments, Trocars</i>	202-217
09	<i>Vaginal Specula & Retractors</i>	219-230
10	<i>Utrine Dilators, Probes, Forceps, Myoma Instruments</i>	231-246





Content

11	<i>Biopsy Instruments, Utrine Currettes / Scoops</i>	247-255
12	<i>Obstetrics Instruments</i>	256-264
13	<i>Tracheotomy, Cardiovascular & Thoracic Surgery</i>	266-318
14	<i>Bone Punches & Rongeurs</i>	319-327
15	<i>Amputation, Elevators, Saws, Raspatories, Bone Livers, Bone Files & Currettes</i>	329-257
16	<i>Mallets, Tampers, Chisels, Gauges, Bone Holding Forceps, Bone Rongeurs, Bone Cutting Forceps, Meniscus Instruments</i>	330-389
17	<i>Wire Extension, Finger Nail Instruments</i>	390-401
18	<i>Plaster Instruments</i>	403-407
19	<i>Suction Instruments</i>	408-414
20	TUNGSTEN CARBIDE INSERTS & HOSPITAL WARES	415-442



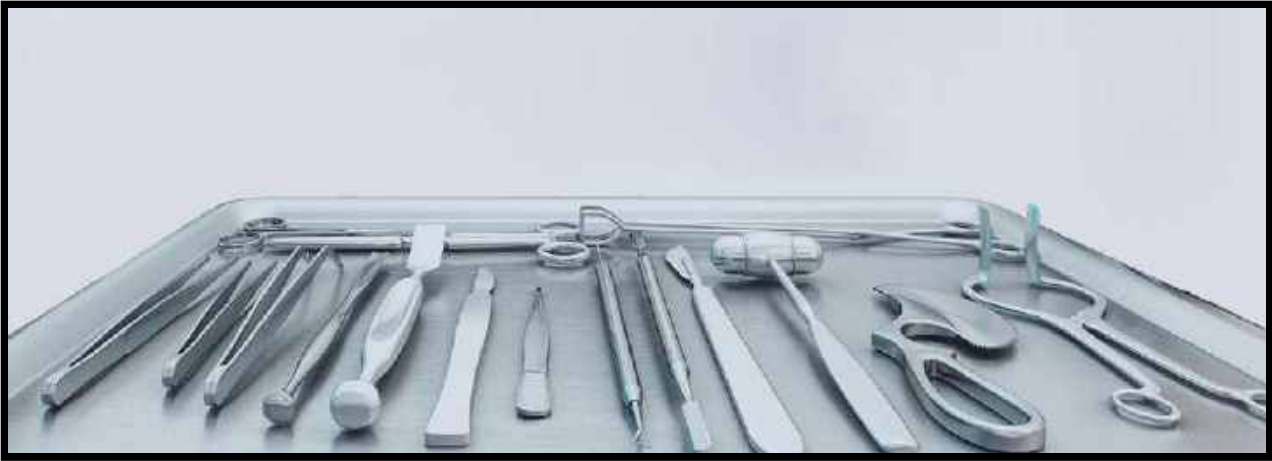

Section - 01



DENVELO SURGICAL[®]
INTERNATIONAL
Serving World of Surgical Since 1996.



Pages 07 - 28

- ★ Diagnostic
- ★ Anaesthesia
- ★ Scalpels
- ★ Knives

Percussion Hammers & Aesthesiometers



01-2001
TROEMNER
 Size: 245 mm
 24.5 cm
 10 inc



01-2002
DEJERINE
 Size: 200 mm
 20 cm
 8 inc



01-2003
DEJERINE
 With Needle.
 Size: 210 mm
 21 cm
 8 inc



01-2004
TAYLOR
 Size: 195 mm
 19.5 cm
 8 inc



01-2005
BERLINER
 Size: 200 mm
 20 cm
 8 inc



01-2006
BUCK
 With Needle
 And Brush
 Size: 180 mm
 18 cm
 7 inc



01-2007
RABINER
 With Needle
 And Brush
 Size: 255 mm
 25.5 cm
 10 inc



01-2008
ALY
 Size: 190 mm
 19 cm
 7 inc



01-2009
WARTENBERG
 Pinwheel For
 Neurological
 Examination
 Size: 185 mm
 18.5 cm
 7 inc

Stethoscopes



01-2010
PINARD
 of aluminium
 Size: 155 mm
 15.5 cm
 6 inc



01-2011
aus Holz
 Wooden
 Size: 145 mm
 14.5 cm
 6 inc



01-2012
BOWLES
 Stethoscope With
 Diaphragm,
 In Plastic Pouch



01-2013
ANESTOPHON
 Ø47mm 4.7 cm



01-2014
FORD-BOWLES
 Combination Stethoscope
 With Diaphragm and Bell
 Dual Chest Piece
 With Two Outlets



01-2015
BOWLES
 Stethoscope With
 Diaphragm,
 Flat Model,
 Suitable Also
 For Anaesthesia
 Chest Piece Only
 40 mm Diam



Head Mirrors & Head Bands



01-2016
ZIEGLER Ø 90mm
Head mirror only
with rubber coating.



01-2017 9 cm
4 inc
ZIEGLER Ø 90mm
Head mirror only
with metal coating



01-2018
ZIEGLER
Head band of plastic, black only



01-2020
MURPHY
Head band of celluloid, white only

01-2019
ZIEGLER
Head band of plastic, white only



01-2021
Head band of plastic,
white, soft pattern



01-2022
Head mirror
with black plastic head
band

Head Lights



01-2026
spare bulb

01-2023
CLAR
Head light, 6 volt, with adjustable joint,
white celluloid head band,
cord with plugs for transformer

01-2024
White celluloid head band, only, for **01-2023**

01-2025
Spare mirror only, for **01-2023**.

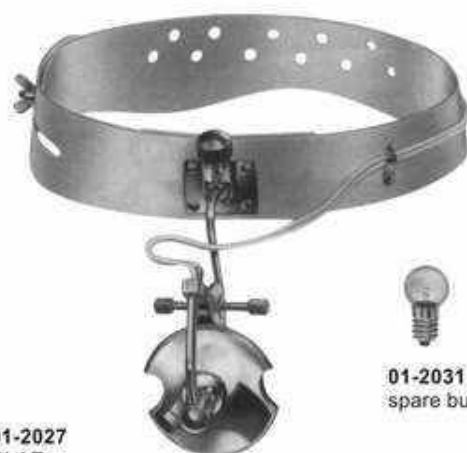

01-2027
CLAR
Head light, 6 volt, with adjustable joint,
white celluloid head band, with foam rubber pad
and cord with plugs for transformer

01-2028
White celluloid head band, only, for head light

01-2029
mirror only, for head light

01-2030
spare foam rubber pad, for head band



01-2033
spare bulb

01-2032
JANSEN
Head light, 6 volt, with adjustable joint,
white plastic head band,
cord with plugs for transformer



01-2035
spare bulb

01-2034
LANGENBECK
Head light, 3.7 volt, with
adjustable joint,
white plastic head band,
cord with plugs for
transformer



01-2036
HERBERHOLD
Pocket-Accu, 6 volts, with cord for head lights



01-2037
Extension cord only, to connect
the accu to the cord of the head lights



01-2038
Charging Set for pocket
accu **01-2036**
mains current: 220-240
volts, 50-60 Hz



01-2039
220 volt / 220 volts
01-2040
120 volt / 120 volts
Transformer

Tongue Depressors, Retractors

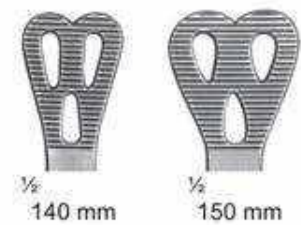
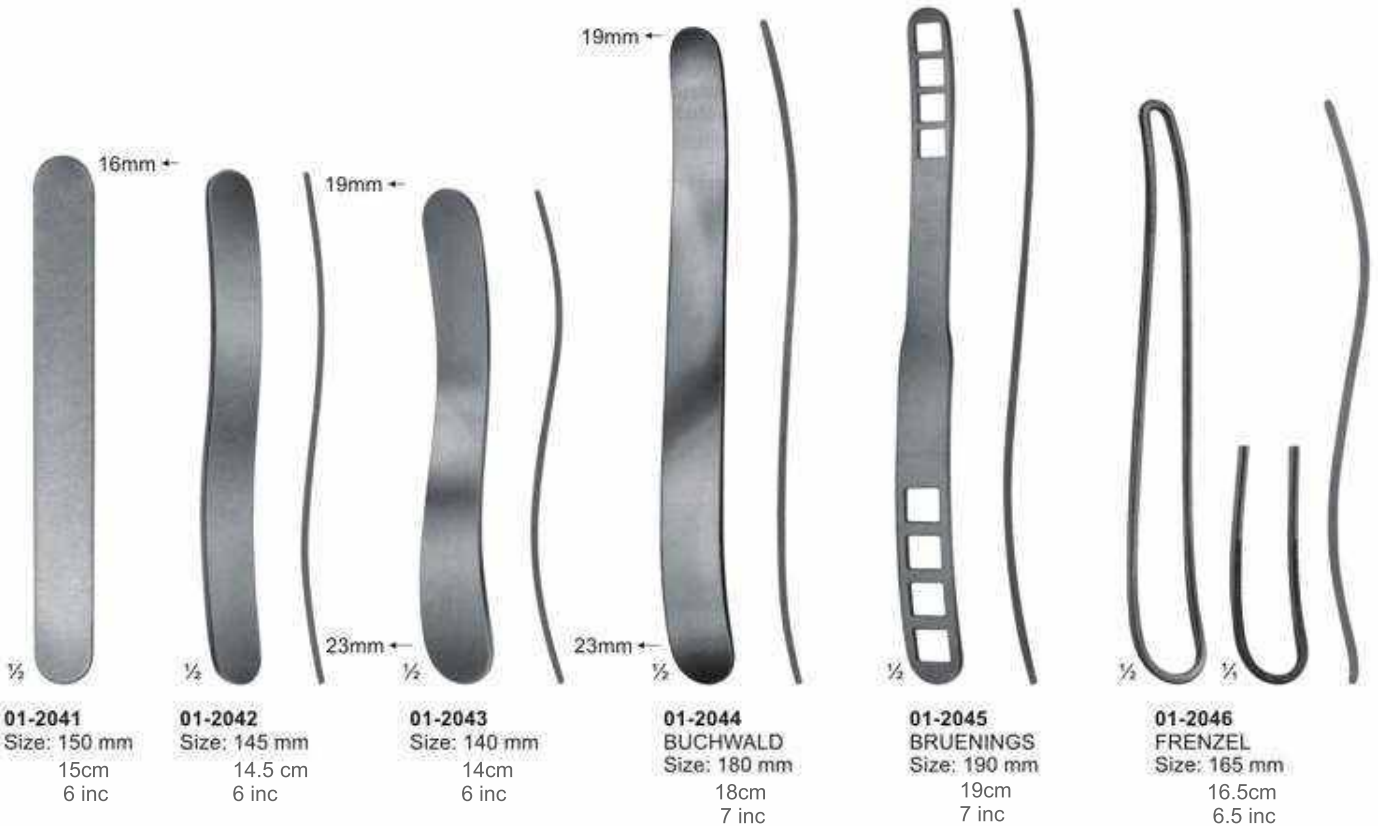

01-2047
SIMPLEX
Cheek and
Lipretractor
Size: 110 mm
11cm
4 inc



01-2048-01-2050
STERNBERG
Cheek and Lipretractor:
01-2048 120mm /12cm
01-2049 140mm /14cm
01-2050 160mm /16cm



01-2051
TOBOLD
Tongue depressor
Size: 145 mm
14.5cm
6 inc



01-2052
ANDREW
Tongue depressor
Size: 110 mm
11cm
4 inc



01-2053-01-2054
WIEDER
Tongue depressor
01-2053 140mm 14cm
01-2054 150mm 15cm

Mouth Gags And Tongue Forceps



01-2055
SCHIMMELBUSCH
 Ether Mask



01-2056
HEISTER
 Mouth Gag
 Size: 130 mm
 13cm
 5 inc



01-2057
FERGUSSON-ACKLAND
 Mouth Gag
 Size: 145 mm
 14.5cm
 6 inc



01-2058
DENHARDT
 Mouth Gag With
 Silicon Inserts,
 Interchangeable
 Size: 125 mm
 12.5cm
 5 inch



01-2059-01-2060
ROSER KOENIG
 Mouth Gag
 Size: **01-2059** 160mm 16cm
01-2060 185mm 18.5cm

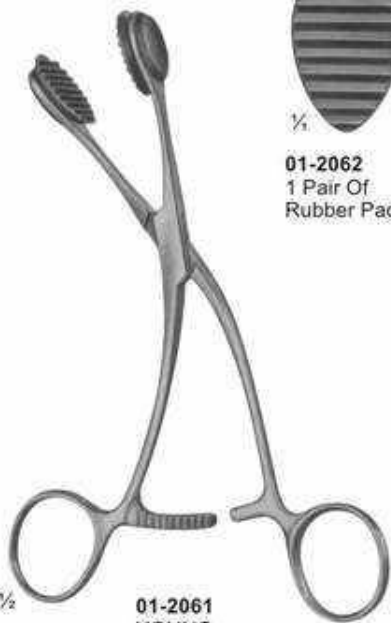

01-2061
YOUNG
 Size: 165 mm
 16.5cm
 6.5inc



01-2062
 1 Pair Of
 Rubber Pads

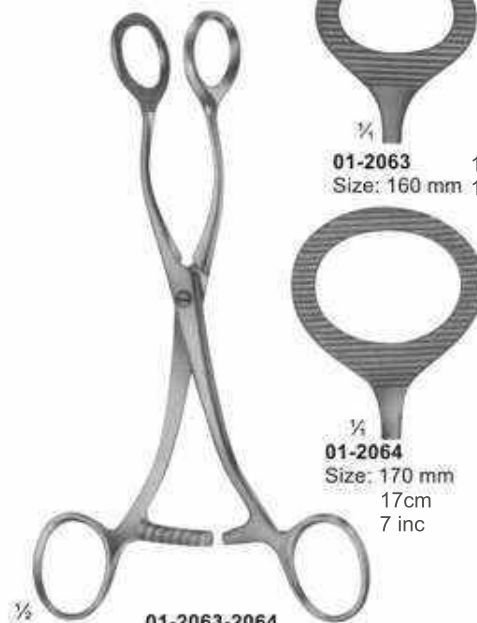

01-2063-2064
COLLIN



01-2063 16cm
 Size: 160 mm 18 inc



01-2064
 Size: 170 mm
 17cm
 7 inc

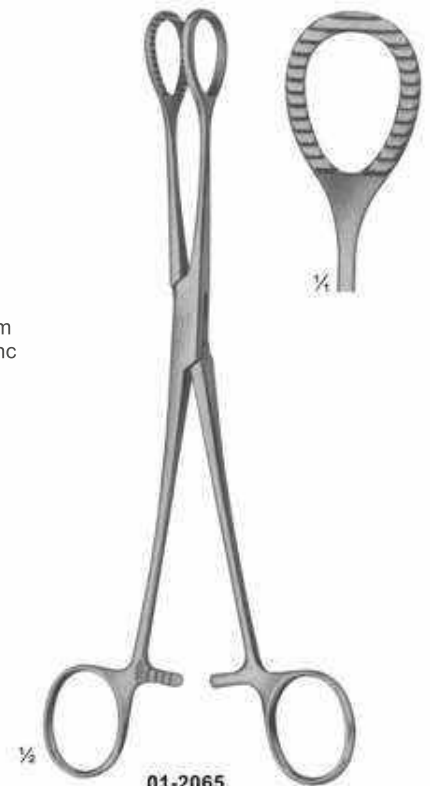

01-2065
HEYWOOD-SMITH modif.
 Size: 215 mm
 21.5cm
 8inc

Blood Lancets & Laryngeal Mirrors

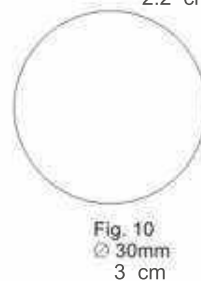
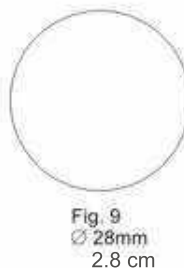
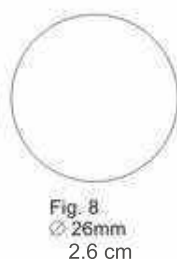
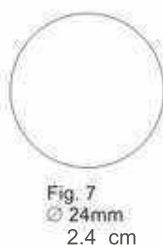
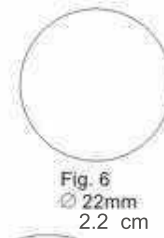
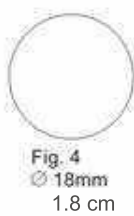
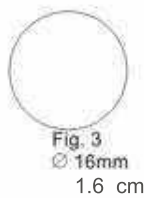
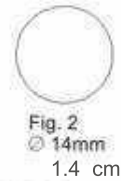
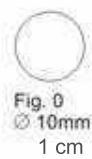

Diagnostic Sets



01-2074 - 01-2076
MAGILL
Catheter Introducing
Forceps



01-2074
Infants
Size: 150 mm
15cm
6 inc



01-2075
Children
Size: 200 mm
20cm
8 inc



01-2076
Adults
Size: 250 mm
25cm
10 inc



01-2077
Medium battery handle
only, 25 mm diam. 2.5 cm



01-2078
Spare bulb
2.7 volt, for
Otoscopes etc.



01-2079
Spare bulb
2.6 volt, for
ophthalmoscopes



01-2080
Otoscope Set, Consists Of
Battery Handle Without Batteries,
3 Ear Specula, 1 Bulb In Velvet Lined Case



01-2081
Diagnostic Set, Otoscope With Three Specula,
Nasal Speculum, Lamp Holder, Two Laryngeal
Mirrors, Tongue Blade Holder

Laryngoscopes



01-2082
MILLER
Laryngoscope Set, Consists Of Battery Handle (Without Battery)
With Five Miller Laryngoscope Blades, Fig 1 to 5

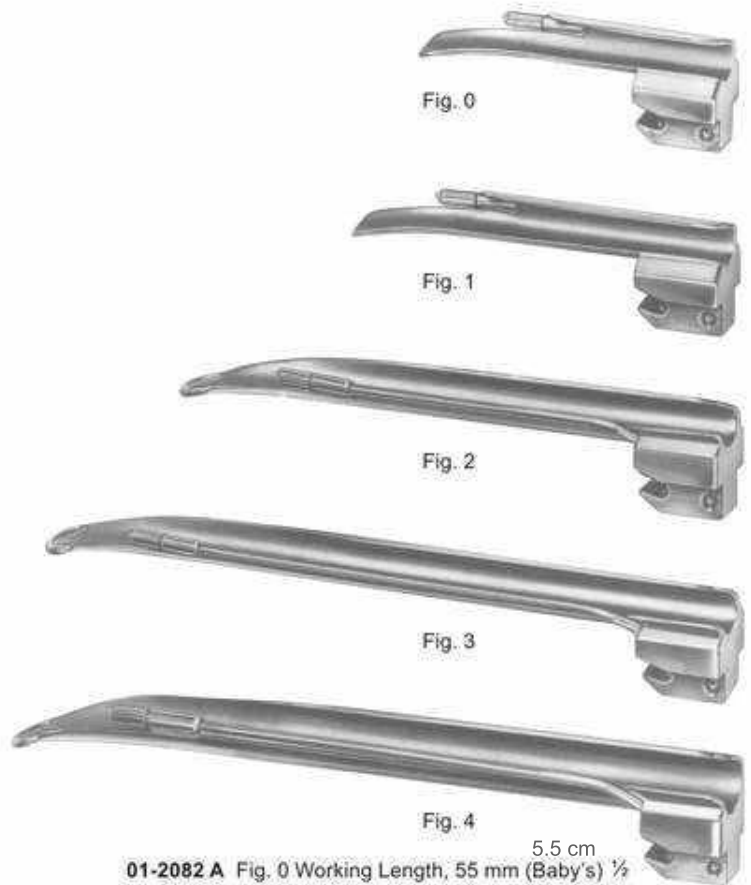

01-2082 A Fig. 0 Working Length, 55 mm (Baby's) 5.5 cm
01-2082 B Fig. 1 Working Length, 80 mm (Children's) 8 cm
01-2082 C Fig. 2 Working Length, 130 mm (Adolescent's) 13 cm
01-2082 D Fig. 3 Working Length, 170 mm (Women's) 17 cm
01-2082 E Fig. 4 Working Length, 180 mm (Men's) 18 cm



01-2083
GUEDEL-NEGUS
Laryngoscope Set, Consists Of Battery Handle (Without Battery)
With Four Miller Laryngoscope Blades

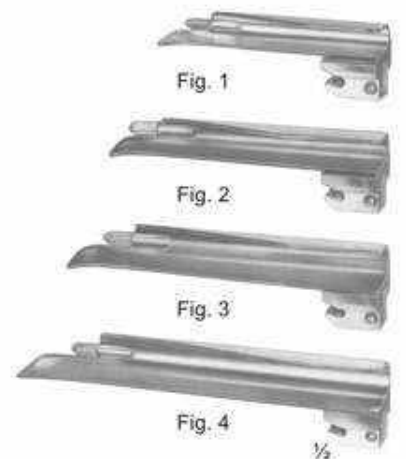

01-2083 A Fig. 1 Working Length, 70 mm (Children's) 7 cm
01-2083 B Fig. 2 Working Length, 90 mm (Adolescent's) 9 cm
01-2083 C Fig. 3 Working Length, 110 mm (Women's) 11 cm
01-2083 D Fig. 4 Working Length, 135 mm (Men's) 13.5 cm

Laryngoscopes



01-2084
McINTOSH
Laryngoscope Set, Consists Of Battery Handle (Without Battery)
With Three McIntosh Blades, Fig. 1, Fig. 2, Fig. 3

01-2085
McINTOSH
Laryngoscope Set, Consists Of Battery Handle (Without Battery)
With Five McIntosh Blades, Fig. 0, Fig. 1, Fig. 2, Fig. 3, Fig. 4

01-2086
FOREGGER
Laryngoscope Set, Consists Of
Battery Handle (Without Battery)
With Three Foregger Blades,
Fig. 1, Fig. 2, Fig. 3,



01-2087
FOREGGER
Laryngoscope Set, Consists Of
Battery Handle (Without Battery)
With Four Foregger Blades,
Fig. 1, Fig. 2, Fig. 3, Fig. 4.



01-2088
Fiber Optic
Battery Handle
30mm diam.
3 cm
1inc



01-2089
Fiber Optic
Battery Handle
18mm diam.
1.8cm

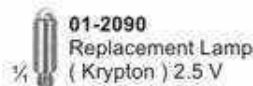

01-2090
Replacement Lamp
(Krypton) 2.5 V



01-2091
Replacement Lamp
(Halogen) 2.5 V



Fig. 0



Fig. 1



Fig. 2



Fig. 3



Fig. 4

01-2085 A Fig. 0 Working Length, 55 mm (Baby's) 5.5 cm
01-2085 B Fig. 1 Working Length, 75 mm (Children's) 7.5 cm
01-2085 C Fig. 2 Working Length, 90 mm (Adolescent's) 9 cm
01-2085 D Fig. 3 Working Length, 110 mm (Women's) 11 cm
01-2085 E Fig. 4 Working Length, 135 mm (Men's) 13.5 cm



Fig. 1



Fig. 2



Fig. 3



Fig. 4

01-2086 A Fig. 1 Working Length, 70 mm (Children's) 7 cm
01-2086 B Fig. 2 Working Length, 90 mm (Adolescent's) 9 cm
01-2086 C Fig. 3 Working Length, 110 mm (Women's) 11 cm
01-2086 D Fig. 4 Working Length, 135 mm (Men's) 13.5 cm

Examination & Measuring Instruments



01-2092
 Caliper Of Aluminium
 Graduated in mm & inches
 up to 180mm
 Measuring Range up to 139mm
 13.9 cm
 5inc



01-2093
 VERNIER
 Universal Caliper Of Steel
 Graduated in mm & inches
 up to 180mm 18cm /7.09inc
 Measuring Range up to 120mm 12cm
 with Vernier in 1/10mm & 1/16"



01-2094
 CARROLL
 Size: 145 mm 14.5cm/6inc
 Finger Goniometer



01-2095
 TOWNLEY
 Graduated in
 mm & inches
 Size: 115 mm
 11.5 cm
 5 inc



01-2096
 COLLIN
 Druck Pressure 72 kg
 Size: 125 mm /12.5cm /5inc



01-2097
 BERTILLON
 Caliper For Measuring The Head
 Size: 320 mm /32cm /12inc



01-2098
 CASTROVIEJO
 Caliper
 Size: 75mm /7.5cm /3inc



01-2099
 MOLTGEN
 Goniometer



01-2100A
 Size: 150 mm
 15 cm.
 5.91 inc



01-2100
 Size: 500 mm
 50 cm.
 19.69inc



Dissecting Knives



01-2101 - 01-2110
 Fig. 1 - 10
 With Metal Handle



01-2101
 Fig. 1
 Size: 30mm
 3 cm.



01-2102
 Fig. 2
 Size: 36mm
 5.6 cm.



01-2103
 Fig. 3
 Size: 40mm
 4 cm.



01-2104
 Fig. 4
 Size: 45mm
 4.5 cm.



01-2105
 Fig. 5
 Size: 50mm
 5 cm.



01-2106
 Fig. 6
 Size: 27mm
 2.7cm.
 1.06inc



01-2107
 Fig. 7
 Size: 35mm
 3.5 cm



01-2108
 Fig. 8
 Size: 40mm
 4 cm



01-2109
 Fig. 9
 Size: 47mm
 4.7 cm



01-2110
 Fig. 10
 Size: 50mm
 5 cm

Autopsy & Cartilage Knives

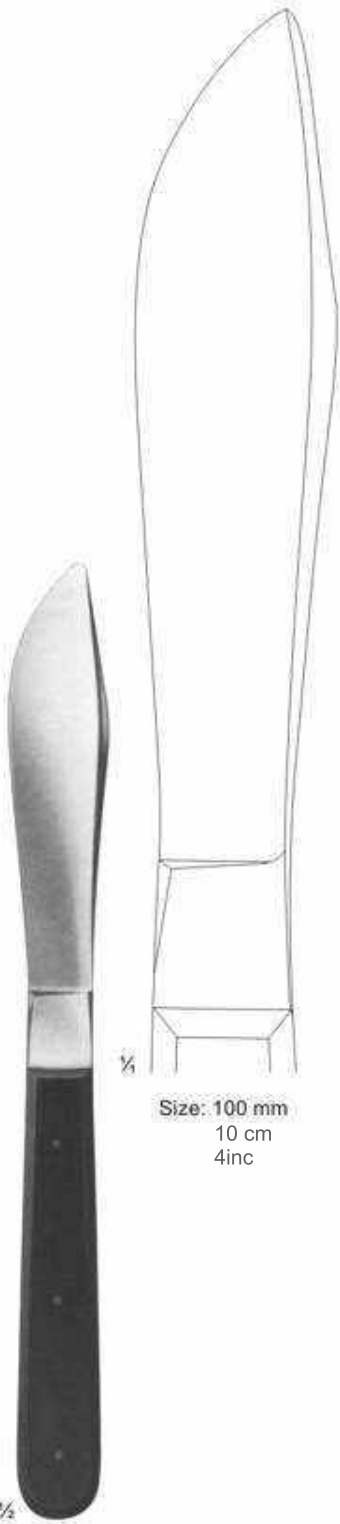

01-2111 10 inc
 Size: 255 mm 25cm
 wooden handle.

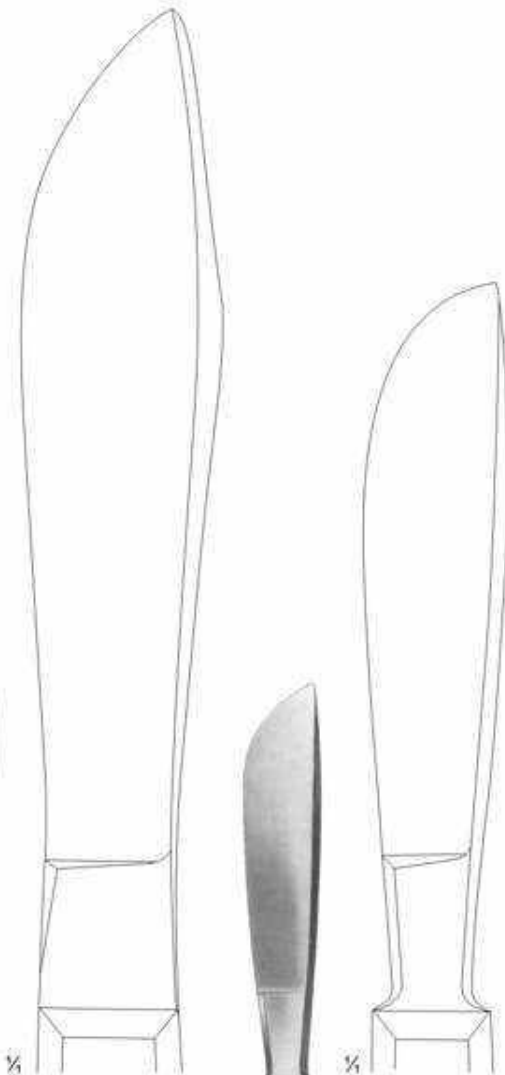

Size: 100 mm
 10 cm
 4inc



Size: 80 mm
 8 cm.
 3inc



01-2113 - 01-2115
 WALB
 with wooden handle

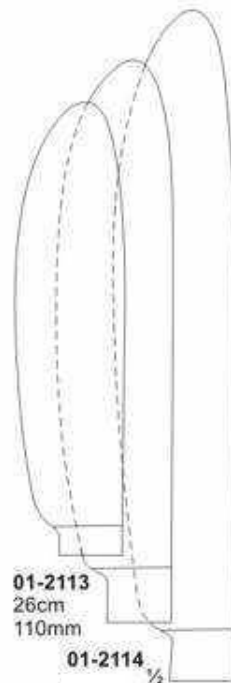

01-2113
 26cm
 110mm

01-2114
 140mm
 14 cm.
 6inc

01-2115
 170mm
 17cm.
 7 inc



01-2116 - 01-2118
 VIRCHOW
 with hollow handle

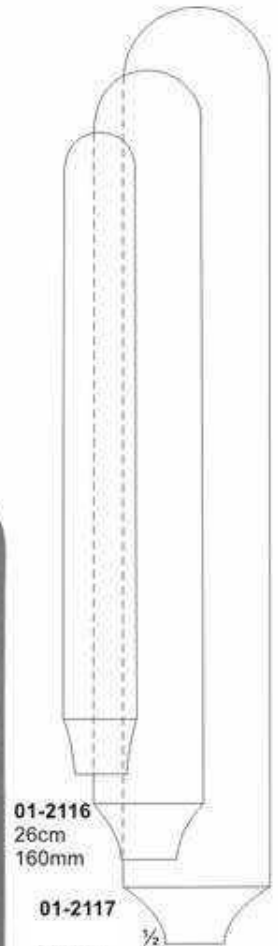

01-2116
 26cm
 160mm

01-2117
 200mm
 20 cm
 8inc

01-2118
 240mm
 24 cm.
 9inc

Scalpels, Tenotomes & Resection Knives

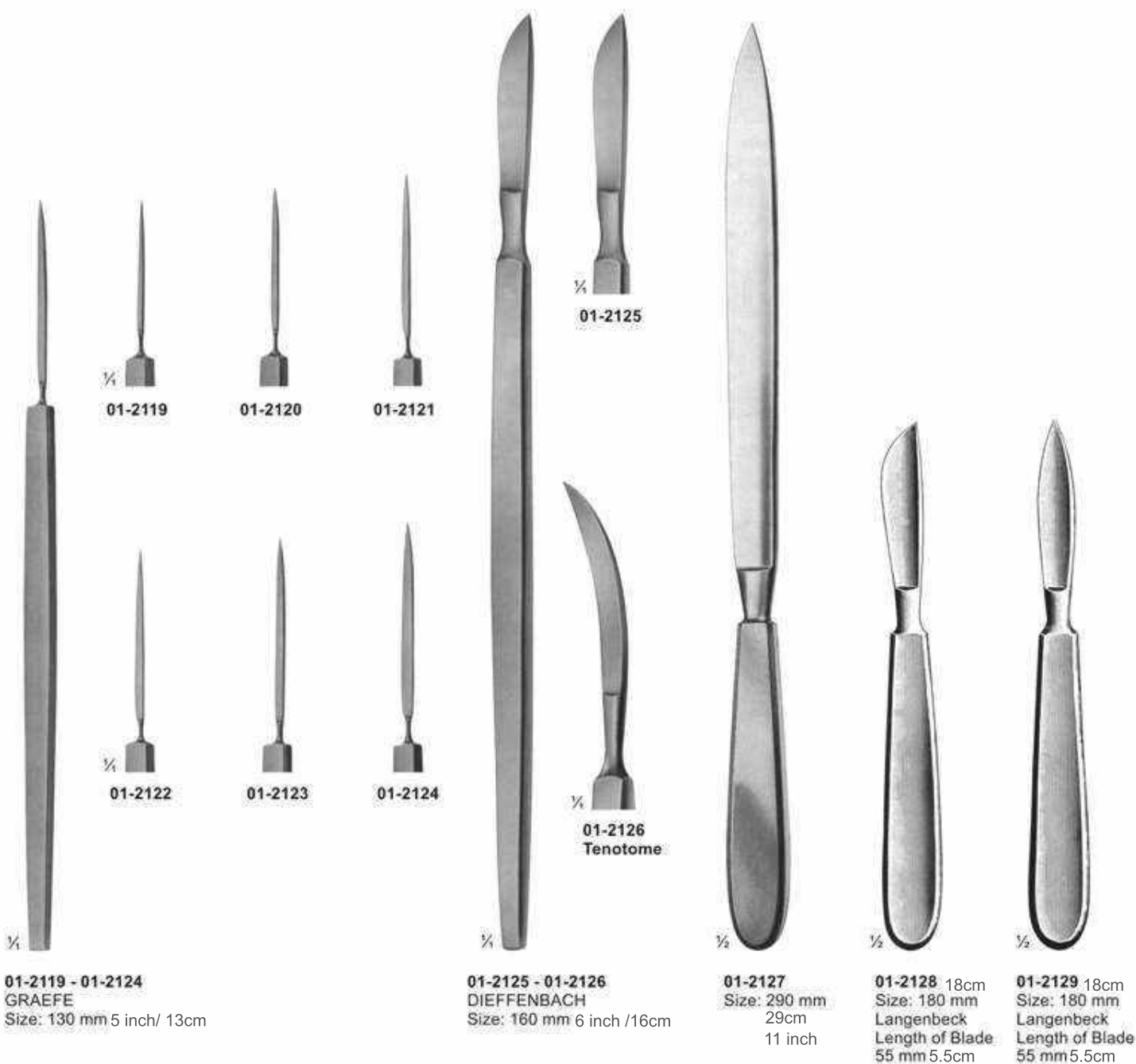

01-2119 - 01-2124
 GRAEFE
 Size: 130 mm 5 inch / 13cm

01-2125 - 01-2126
 DIEFFENBACH
 Size: 160 mm 6 inch / 16cm

01-2127
 Size: 290 mm
 29cm
 11 inch

01-2128 18cm
 Size: 180 mm
 Langenbeck
 Length of Blade
 55 mm 5.5cm

01-2129 18cm
 Size: 180 mm
 Langenbeck
 Length of Blade
 55 mm 5.5cm

Scalpels, Tenotomes

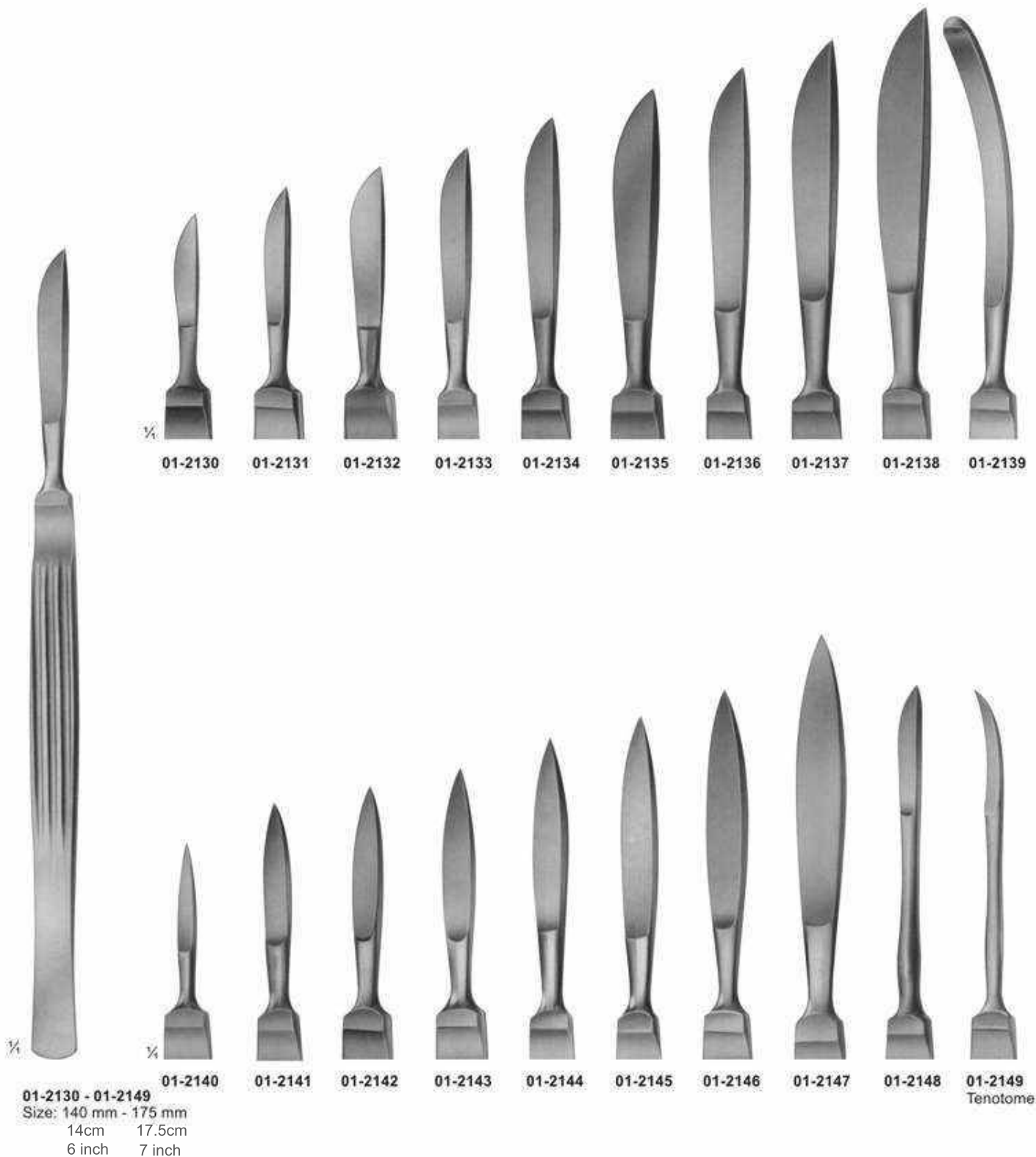



Amputating Knives, Cartilage Knives, Autopsy

Double Cutting

Double Cutting



LISTON

01-2150 13cm
Size: 130 mm

01-2151 16cm
Size: 160 mm

01-2152 19cm
Size: 190 mm

01-2153 22cm
Size: 220 mm

Blade Length
Amputating Knives

01-2154

CATLIN 16cm
Size: 160 mm

Blade Length
Amputating
Knives

01-2155

LANGENBECK
Size: 120 mm

Blade Length
Flap Knives
12cm

01-2156

Size: 110 mm

Blade Length
Interosseous
Knives 11cm

01-2157 5.5cm

Size: 55 mm
Blade Length
With Raspatory,
Wooden Handle

01-2158 7cm

Size: 70 mm
Blade Length
Wooden Handle

01-2159 8cm

Size: 80 mm
Blade Length
Metal Handle

01-2160 19.5cm

Size: 195 mm
Blade Length
Metal Handle



Cone Knives, Myomatome, Trigeminal & Tonsil



01-2161
 AYRE 23.5cm
 Size: 235 mm
 Cone Knife

01-2162 23cm
 Size: 230 mm
 Cone Knife

01-2163
 SEGOND
 Size: 270 mm /27cm
 Myomatome

01-2164
 OLIVECRONA
 Size: 205 mm
 Trigeminal
 Knife

01-2165
 Size: 230 mm
 Trigeminal
 Knife 23cm

01-2166
 FOWLER 20cm
 Size: 200 mm
 Tonsil Knife

01-2167
 ABRAHAM
 Size: 215 mm
 Tonsil Knife
 21.5cm

01-2168
 BRUENINGS
 Size: 215 mm
 Tonsil Knife
 21.5cm

Scalpels, Dura Knives & Comedone Extractors



1/2

01-2169 - 01-2170
JOSEPH
Size: 145 mm /14.5cm /6 inch
Double Edged
Nasal Knives, Pointed.



1/4

01-2169
Straight



1/4

01-2170
Curved



1/4

01-2171 - 01-2173
ZIEGLER
Size: 120 mm /12cm /5 inch
Millium Knives



1/4

01-2171
Small



01-2172
Large



01-2173
Pointed



1/2

01-2174
VIDAL
Lupus Scraper
Size: 125 mm
13.5cm
5 inch

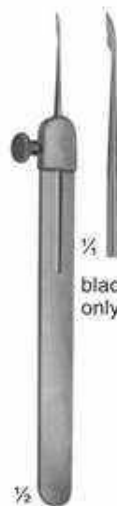

1/2

01-2175
MONCORPS
Millium Knives
Size: 130 mm
13cm
5 inch

1/4
blade
only



1/2

01-2176
SAALFELD
Size: 100 mm
10cm
4 inch



1/2

01-2177
HEBRA
Size: 180 mm
18cm
7 inch



1/2

01-2178
Size: 145 mm
14.5cm
6 inch



1/2

01-2179
UNNA
Size: 145 mm
14.5cm
6 inch

Razor Blade Holders & Breakers



01-2180
TROUTMAN-CHRIS
 Size: 90 mm /9cm/4 inch
 Handle Diameter 5.5 mm



01-2181
TROUTMAN-CHRIS
 Size: 90 mm /9cm/4 inch
 Handle Diameter 5.5 mm



01-2182
 Size: 110 mm
 11cm
 4 inch



01-2183
CASTROVIEJO
 Size: 130 mm /13cm/5 inch
 Handle Diameter 8 mm



01-2184
 Size: 185 mm 18.5cm
 Razor Blade 7 inch
 Breaker & Holder,
 Straight

Scalpel Handles



01-2185
STANDARD
No. 4
Solid

01-2186
Double Handle
No. 4 + No. 3
Solid

01-2187
No. 4 L
Straight
Solid

01-2188
No. 4 L
Solid Angled

01-2189
COLLIN
No. 8
Hollow

01-2190
COLLIN
No. 9
Hollow

01-2191
Plastic
No.4

Scalpel Handles

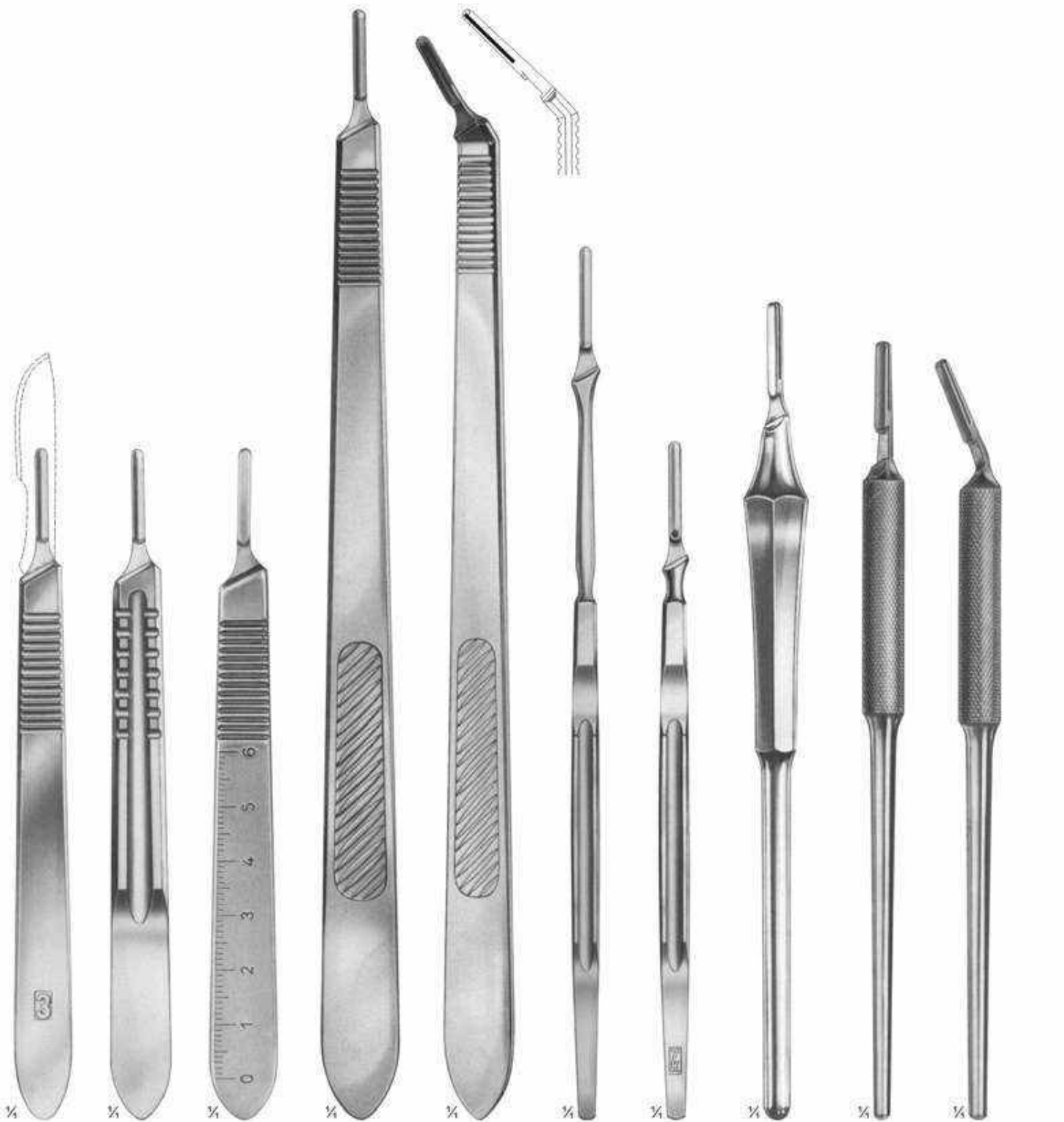

01-2192
STANDARD
No. 3
Solid
Size:12cm
120mm
5 inch

01-2193
No. 3
Solid
Size:12cm
solid handle
style as 120mm
5 inch

01-2194
No. 3
Solid
Size:12cm
cm-graduation
120mm
5 inch

01-2195
No. 3 L
Straight
Solid, long
Size:21.5cm
215mm
8 inch

01-2196
No. 3 L
Angled
Solid, long
Size:21cm
215mm
8 inch

01-2197
No. 7
Solid
Size:16cm
160mm
6 inch

01-2198
No. 7 K
Solid, short
Size:12.5cm
125mm
5 inch

01-2199
No.3
Size:15.5cm
with round
hollow handle

01-2200
No. 3
Straight
Solid,
Round
Size:14.5cm
6 inch

01-2201
No. 3
Angled
Solid, Round
Size:14cm
6 inch

Razors & Dermatomes



01-2202
SCHINK
 Size: 310 mm /31cm /12 inch
 Complete with 2
 skin fixing plates
 and 1 blade.
 Adjustable from
 0.1 to 2.0mm



01-2203
SCHINK
 Spare Blade



01-2204
SCHINK
 Skin Fixing Plate



01-2205
SILVER
 Size: 190 mm /19cm /7 inch
 For Usual
 Razor Blades



01-2206
SCHINK
 Size: 75 mm /7.5cm /3 inch
 Cutting Length



01-2207
SCHINK
 Size: 80 mm /8cm /3 inch
 Cutting Length

Section - 02



Pages 29-121

- ★ Scissors
- ★ Forceps, Clamps
- ★ Needle Holders,
Micro Needle Holders
- ★ Suture Instruments,
Needles, Probes, Applicators,
Pocket Instruments Set.

Micro Scissors, "Spring Type" Flat Handles

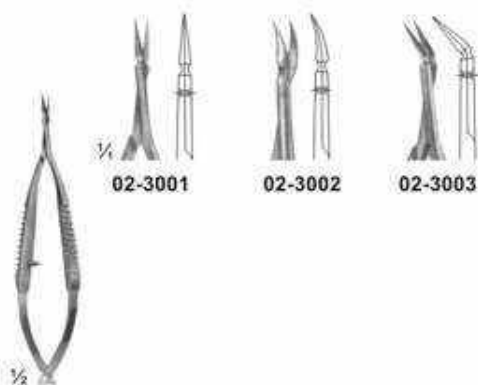

02-3001 - 02-3003
VANNAS
 Size: 85 mm / 8.5cm / 3 inch



02-3004 - 02-3005
CASTROVIEJO
 Size: 95 mm / 9.5cm / 4 inch

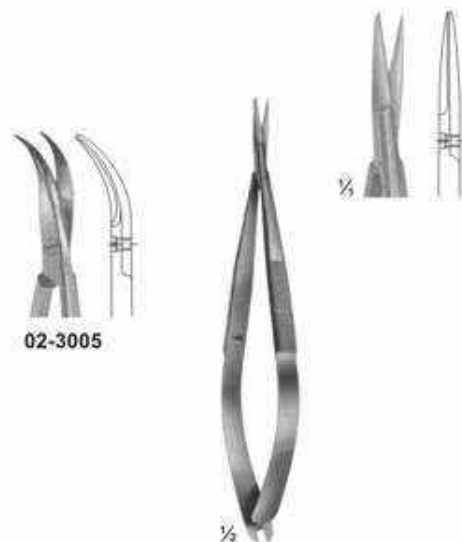

02-3006
NOYES
 Size: 125 mm / 12.5cm / 5 inch



02-3007 - 02-3008
WECKER
 Eye Scissor
 Size: 110 mm / 11cm / 4 inch



02-3009
CASTROVIEJO
 Eye Scissor
 Size: 115 mm / 11.5cm / 5 inch

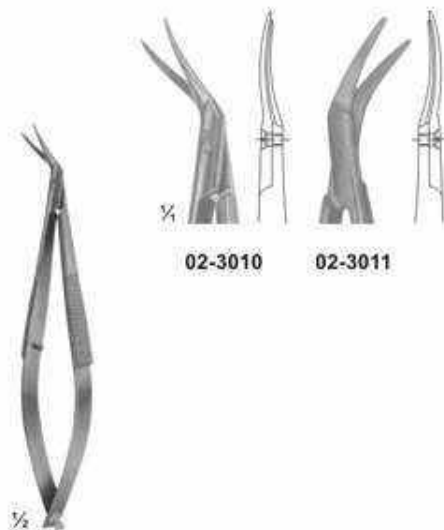

02-3010 - 02-3011
CASTROVIEJO
 Eye Scissor
 Size: 110 mm / 11cm / 4 inch

Micro Scissor, Spring Type Flat Handels
and Cross-Serration

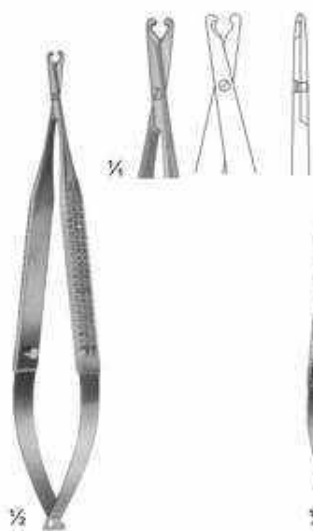

02-3012
BIEMER
Vein Scissor
Size: 130 mm /13cm/5 inch

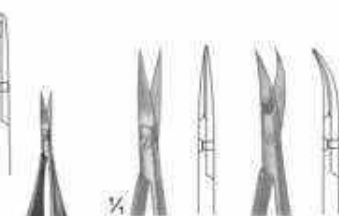
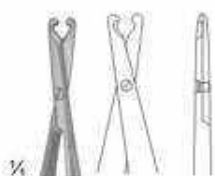

02-3013 - 02-3014
Size: 120 mm/12cm/5 inch

02-3013 **02-3014**



02-3015 - 02-3016
Size: 160 mm/16cm/6 inch

02-3015



02-3016

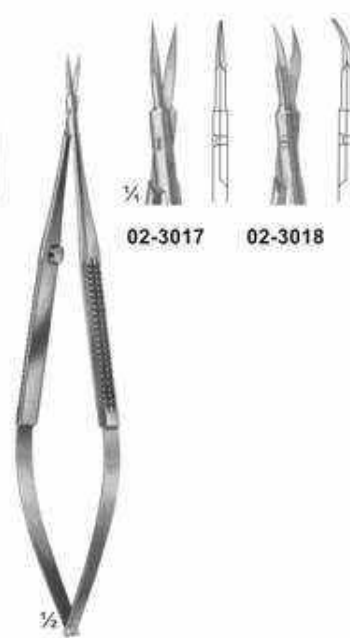

02-3017 - 02-3018
VANNAS
Size: 160 mm/16cm/6 inch

02-3017

02-3018



02-3019
CASPAR
Micro Scissor Curved

360° Rotatable
115 mm

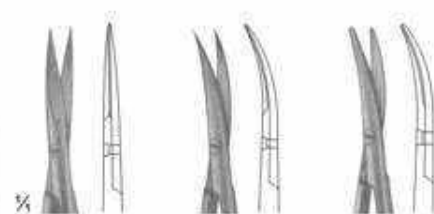

02-3020

02-3021

02-3022



02-3020 - 02-3022
Micro Dissecting Scissor
Size: 145 mm/14.5cm/6 inch

Micro Scissors, "Spring Type" Bayonet Shape



02-3023
 YASARGIL
 Size: 245 mm
 24.5/10 inch

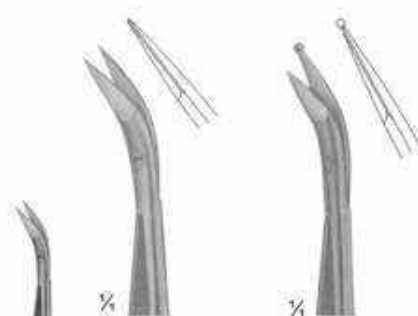

02-3024
 45°
 Nagel

02-3025
 45°



02-3026
 Laterally Angled
 Size: 190 mm/190cm/7 inch
 19cm
 7 inch



02-3024 - 02-3025
 Laterally Angled
 Size: 200 mm/20cm/8 inch

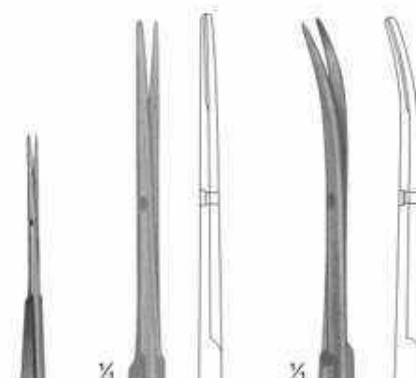

02-3027

02-3028



02-3027 - 02-3028
 YASARGIL
 Size: 225 mm/22.5cm/9 inch
 22.5cm
 9 inch

Delicate Scissors



02-3029



02-3030

02-3029-02-3030
Size: 120 mm
12cm
5 inch

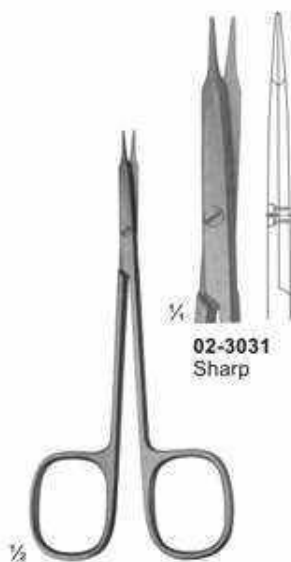

02-3031
Sharp



02-3032
Sharp

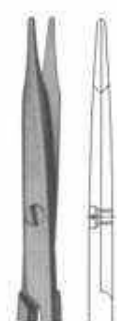

02-3033
Blunt

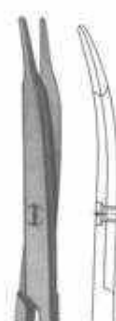

02-3034
Blunt

02-3031 - 02-3034
STEVENS
Dissecting Scissors
Size: 115 mm
11.5cm
6 inch

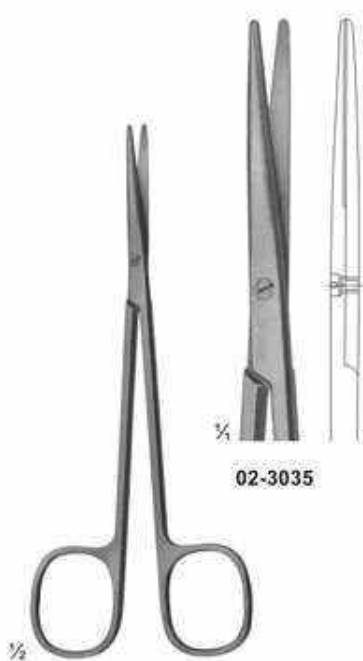

02-3035

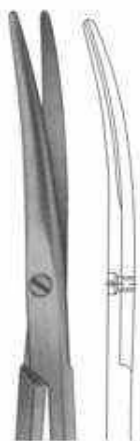

02-3036

02-3035 - 02-3036
METZENBAUM
Dissecting Scissors
Size: 145 mm
14.5cm
6 inch



02-3037
RAGNELL
Size: 135 mm
13.5cm
5 inch

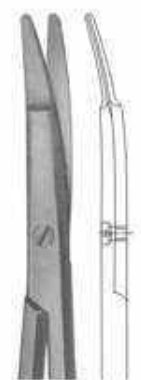

02-3038
RAGNELL
Size: 135 mm
13.5cm
5 inch



02-3039
Size: 150 mm
15cm
6 inch

02-3037 - 02-3039
Special flat points for
dissecting and
undermining the skin

Delicate Scissors



02-3040

02-3041



02-3042

02-3043



02-3044

02-3045

02-3040 - 02-3041

Size: 90 mm
 9cm
 4 inch

02-3042 - 02-3043

Size: 95 mm
 9.5cm
 4 inch

02-3044 - 02-3045

Size: 105 mm
 10.5cm
 4 inch



02-3046

02-3047



02-3048

02-3049

02-3046 - 02-3047

Size: 120 mm
 12.5cm
 5 inch

02-3048 - 02-3049

Size: 115 mm
 11.5cm
 5 inch

Delicate Scissors



02-3050 - 02-3052
 Size: 120 mm
 12cm
 5 inch

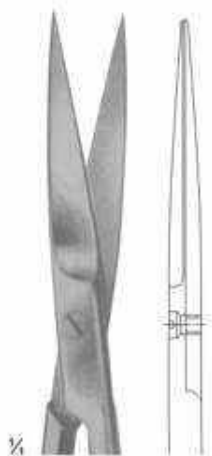

02-3050

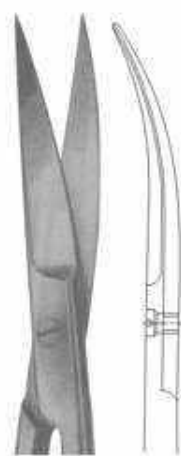

02-3051

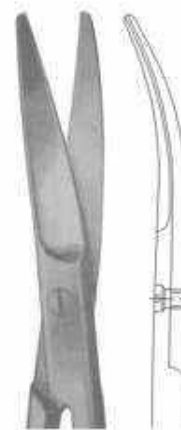

02-3052



02-3053 - 02-3056
 Size: 130 mm
 13cm
 5 inch

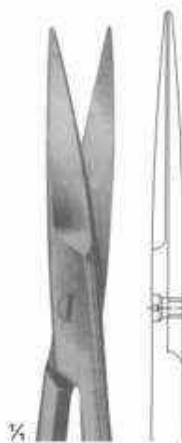

02-3053

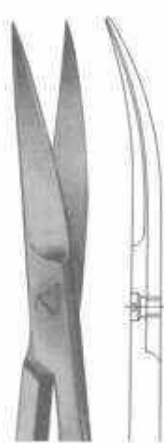

02-3054

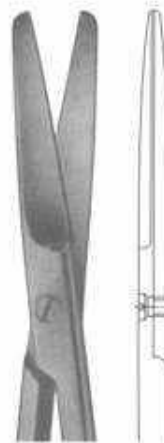

02-3055

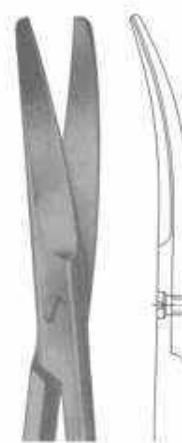

02-3056

Delicate Scissors

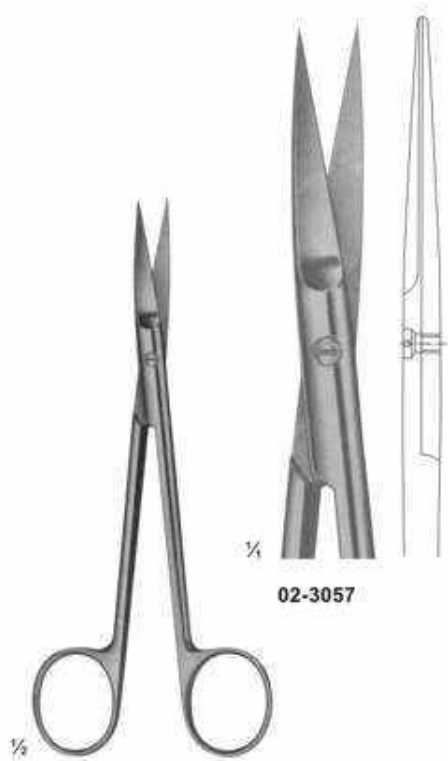

02-3057

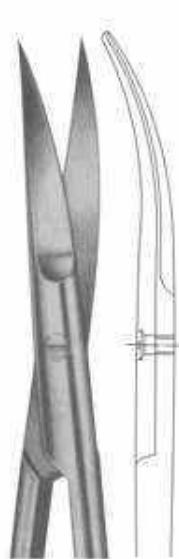

02-3058

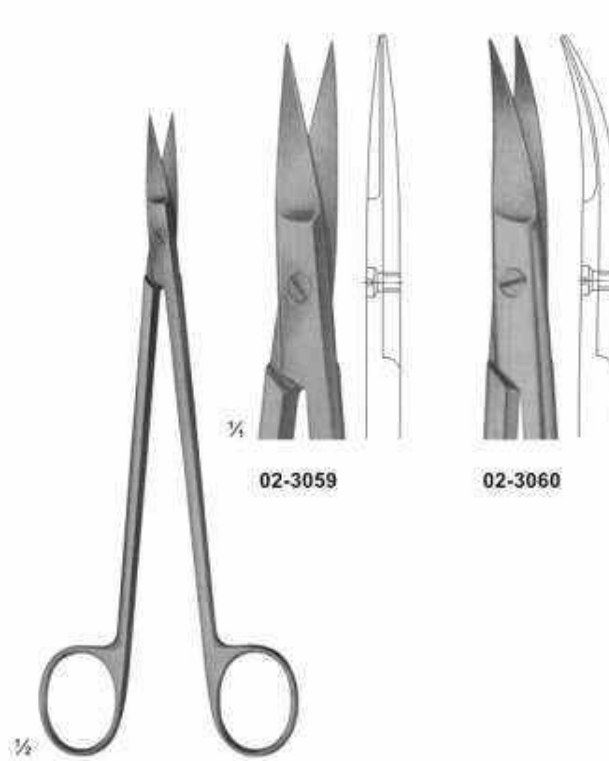

02-3059

02-3060

02-3057 - 02-3058

JOSEPH

Size: 150 mm

15cm

6 inch

02-3059 - 02-3060

KELLY

Size: 175 mm

17.5cm

7 inch

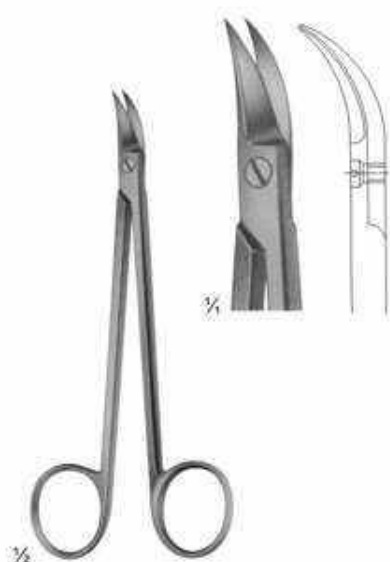

02-3061

QUINBY

Size: 130 mm

13cm

5 inch

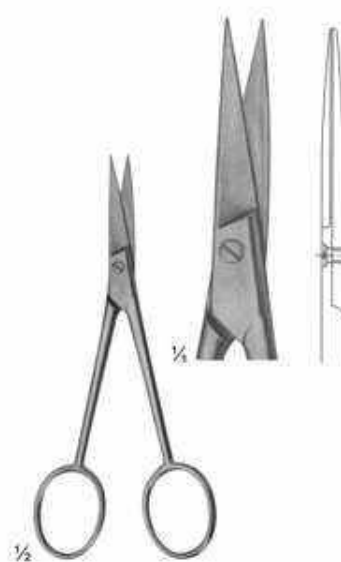

02-3062

Size: 110 mm

11cm

4 inch

Surgical Scissors



02-3063 - 02-3071 (Standard Types)
02-3063 (105 mm) 10.5cm
02-3064 (115 mm) 11.5cm
02-3065 (130 mm) 13cm
02-3066 (145 mm) 14.5cm
02-3067 (150 mm) 15cm
02-3068 (165 mm) 16.5cm
02-3069 (175 mm) 17.5cm
02-3070 (185 mm) 18.5cm
02-3071 (200 mm) 20cm



02-3063
Size: 105 mm
10.5cm



02-3071
Size: 200 mm
20cm



02-3072 - 02-3078 (Standard Types)
02-3072 (115 mm) 10.5cm
02-3073 (130 mm) 13cm
02-3074 (145 mm) 14.5cm
02-3075 (150 mm) 15cm
02-3076 (165 mm) 16.5cm
02-3077 (175 mm) 17.5cm
02-3078 (185 mm) 18.5cm



02-3072
Size: 115 mm
11.5cm



02-3078
Size: 185 mm
18.5cm



02-3079 - 02-3082
Slender Types



02-3079
130 mm
13cm



02-3080
145 mm
14.5cm



02-3081
130 mm
13cm



02-3082
145 mm
14.5cm



02-3083 - 02-3084
For Wound Edges
1 Blade Serrated



02-3083
130 mm
13cm



02-3084
130 mm
13cm

Surgical Scissors



02-3085 - 02-3089 (Standard Types)
02-3085 (130 mm) 13cm /5inch
02-3086 (145 mm) 14.5cm /6inch
02-3087 (150 mm) 15cm /6inch
02-3088 (165 mm) 16.5cm /6inch
02-3089 (175 mm) 17cm /7inch

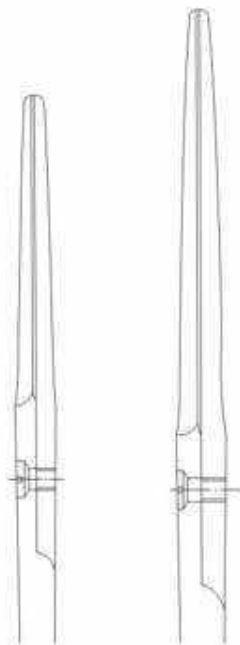

02-3085 Size: 130 mm 13cm 5inch
02-3089 Size: 175 mm 17.5cm 7inch



02-3090 - 02-3095 - COOPER
 Standard Types
02-3090 (115 mm) 11.5cm /5inch
02-3091 (130 mm) 13cm /5inch
02-3092 (145 mm) 14.5cm /6inch
02-3093 (150 mm) 15cm /6inch
02-3094 (165 mm) 16.5cm /6inch
02-3095 (175 mm) 17.5cm /6inch

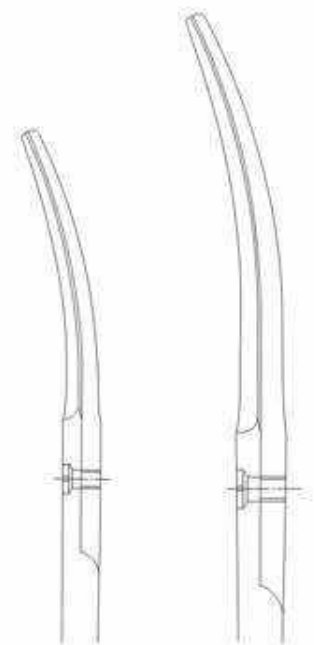

02-3090 Size: 115 mm 11.5cm 5inch
02-3095 Size: 175 mm 17.5cm 7inch



02-3096 - 02-3102A
 Standard Types
02-3096 (115 mm) 11.5cm /5inch
02-3097 (130 mm) 13cm /5inch
02-3098 (145 mm) 14.5cm /6inch
02-3099 (150 mm) 15cm /6inch
02-3100 (165 mm) 16.5cm /6inch

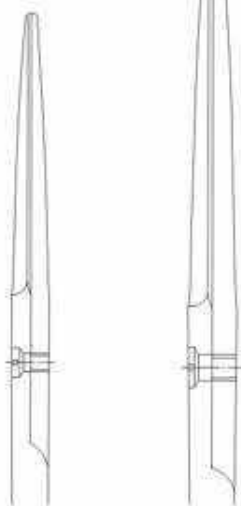

02-3096 Size: 115 mm 11.5cm 5inch
02-3100 Size: 165 mm 16.5cm 6inch

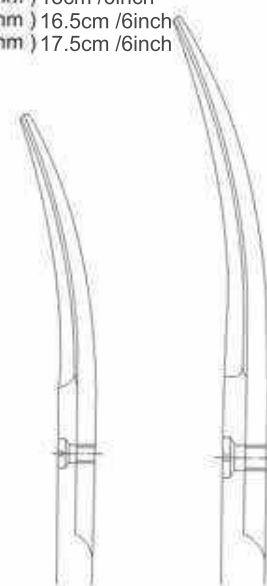

02-3100A Size: 115 mm 11.5cm 5inch
02-3102A Size: 165 mm 16.5cm 6inch

Surgical Scissors



02-3103 - 02-3106
DEAVER
With flat lock

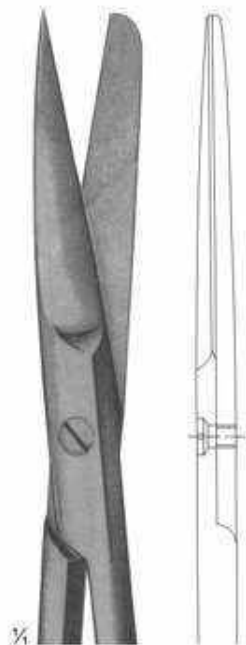

02-3103
Size: 145 mm
14.5cm
5inch

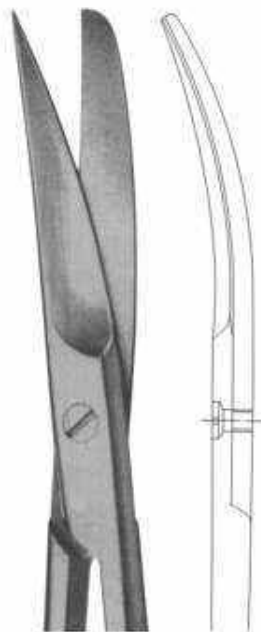

02-3104
Size: 145 mm
14.5cm
5inch

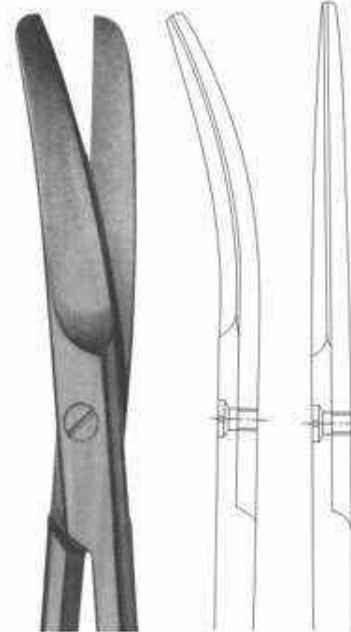

02-3105
Size: 145 mm
14.5cm
5inch



02-3106
Size: 145 mm
14.5cm
5inch



02-3107 - 02-3109
Incision Scissors



02-3107
Size: 130 mm
13cm
5inch

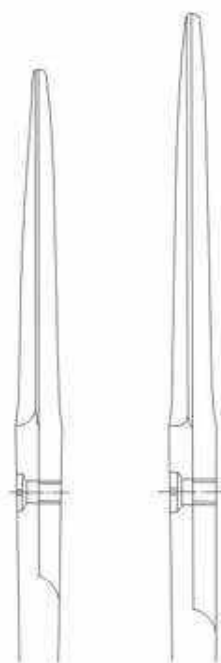

02-3108
Size: 145 mm
14.5cm
5inch



02-3109
Size: 165 mm
16.5cm 2/3
6inch



02-3110
SYSTRUNK
Nail Splitting Scissors

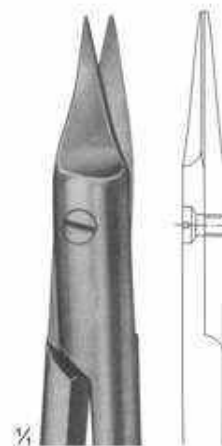

02-3110
Size: 130 mm
13cm
5inch

Dissecting Scissors

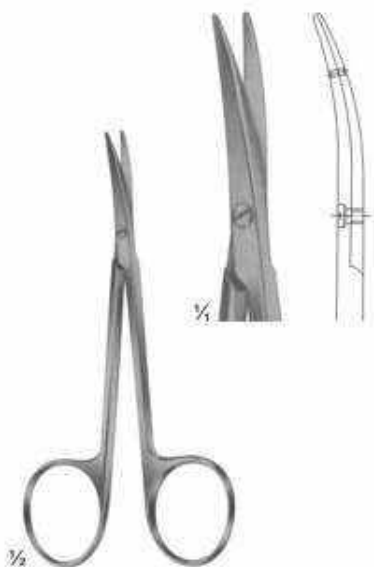

02-3111
LITTLER
Dissecting Scissors
Tips with eye for suture
Size: 115 mm
11.5cm
5inch

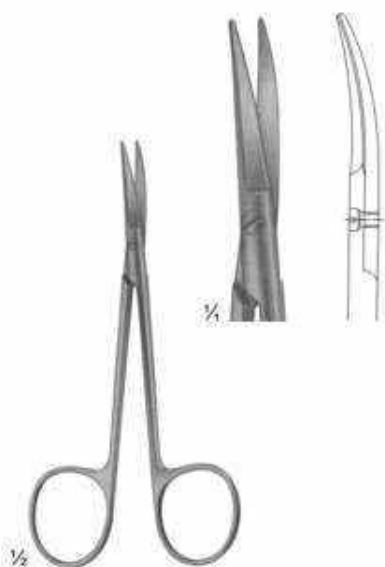

02-3112
COTTLE
Bulldog Scissors
Size: 115 mm
11.5cm
5inch

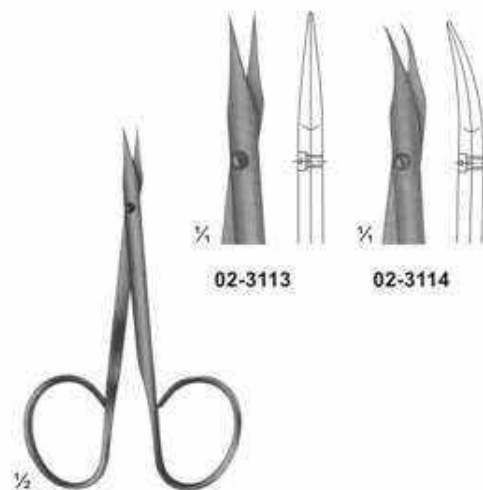

02-3113 - 02-3114
STEVENS
Vessel and tendon Scissors.
Size: 100 mm
10cm
4inch

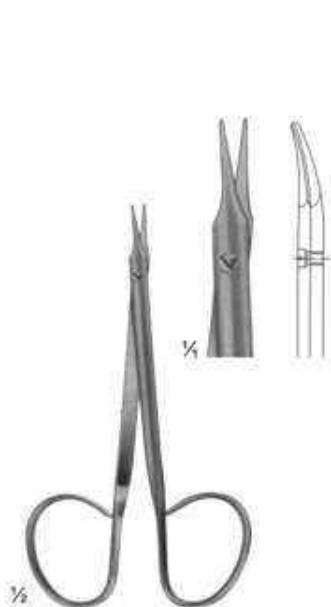

02-3115
STEVENS
Fine Dissecting Scissors
Size: 110 mm
11cm
4inch

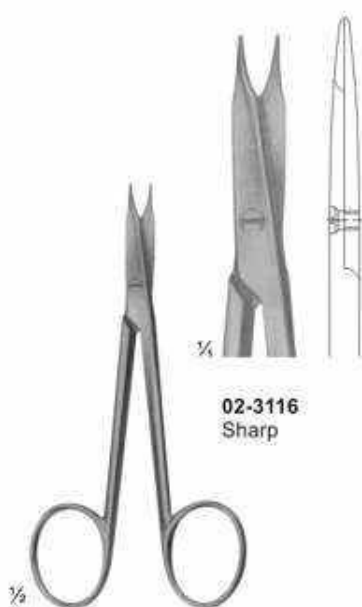

02-3116 - 02-3119
STEVENS
Vessel and tendon Scissors
Size: 110 mm
11cm
4inch



02-3117
Sharp



02-3118
Blunt



02-3119
Blunt

Dissecting Scissors

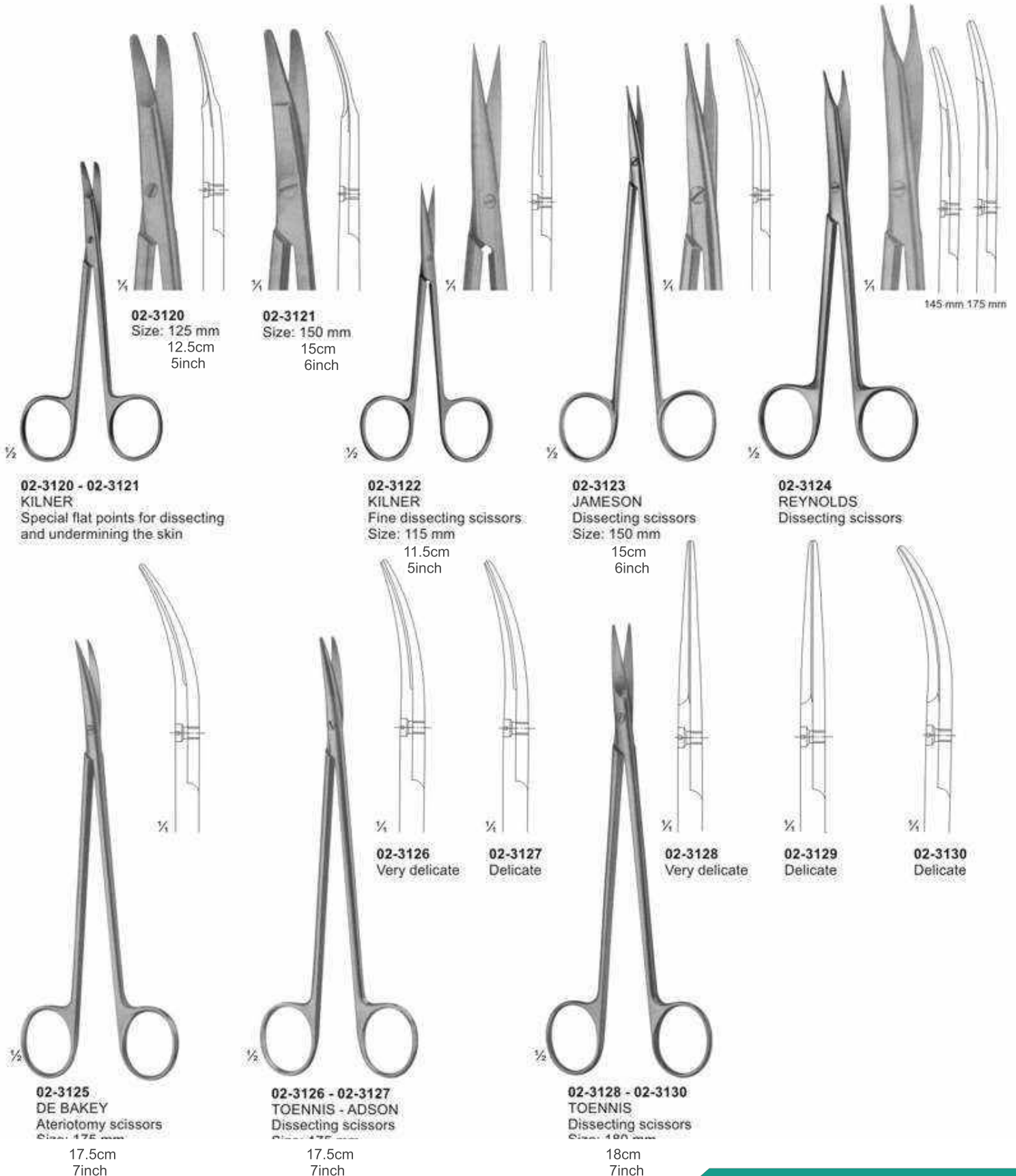

Dissecting & Surgical Scissors

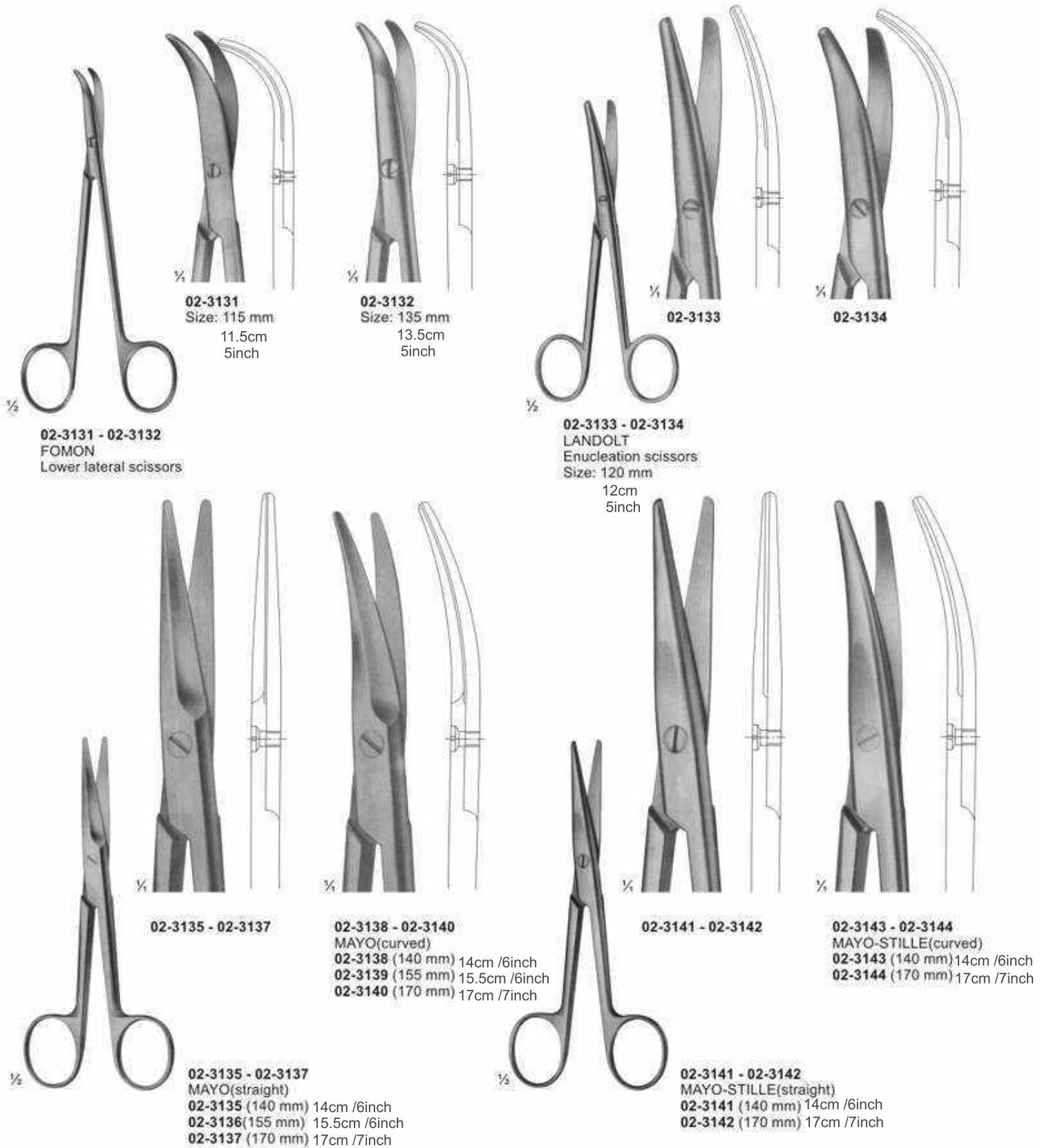

Dissecting Scissors

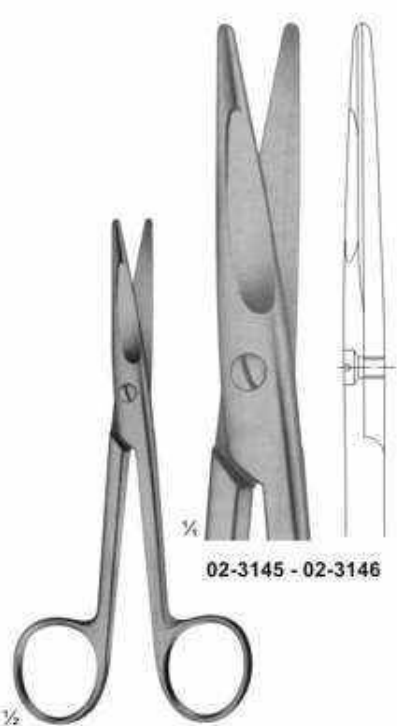

02-3145 - 02-3146

02-3145 - 02-3146
MAYO-STILLE
With chamfered blades
02-3145 (140 mm) 14cm /6inch
02-3146 (170 mm) 17cm /7inch

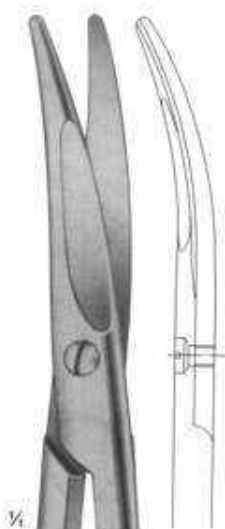

MAYO-STILLE
02-3147 - 02-3148
02-3147 (14cm)
02-3148 (17cm)



02-3149 - 02-3150

MAYO
With chamfered blades
02-3149 (190 mm) 19cm /7inch
02-3150 (215 mm) 21.5cm /8inch



MAYO
02-3151
Size: 190 mm /19cm /7inch
02-3152
Size: 215 mm
21.5cm
8inch



02-3153
Size: 170 mm
17cm
7inch

02-3153 - 02-3154

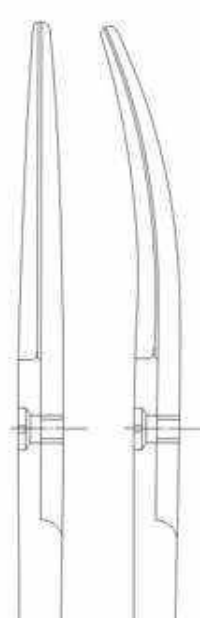

02-3154
Size: 170 mm
17cm
7inch



02-3155 - 02-3156



02-3155
Size: 230 mm
23cm
9inch

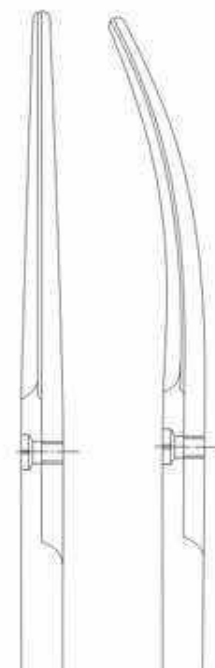

02-3156
Size: 230 mm
23cm
9inch

Dissecting Scissors

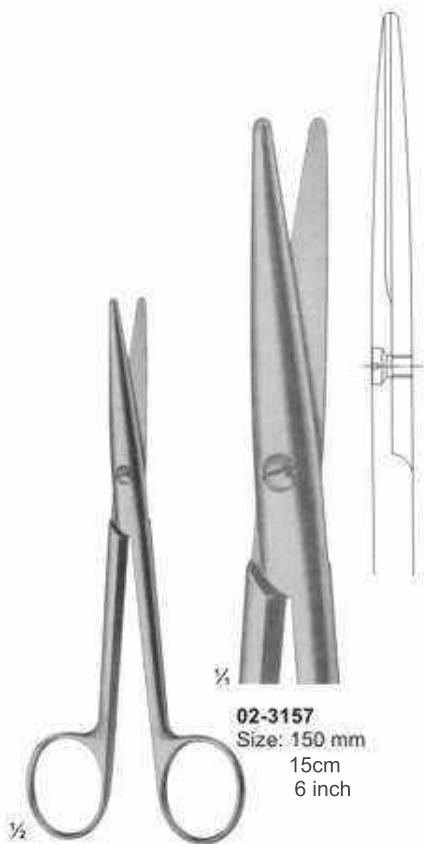

02-3157
Size: 150 mm
15cm
6 inch



02-3158
Size: 150 mm
15cm
6 inch

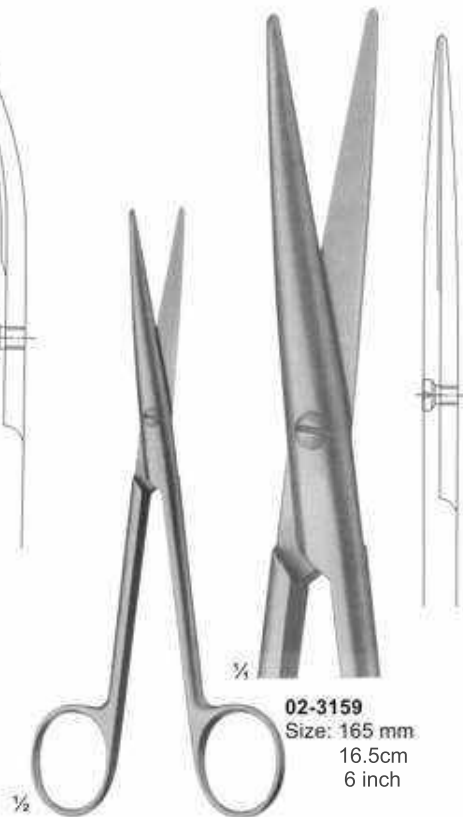

02-3159
Size: 165 mm
16.5cm
6 inch



02-3160
Size: 165 mm
16.5cm
6 inch

02-3157 - 02-3158
STILLE

02-3159 - 02-3160
LEXER
Narrow

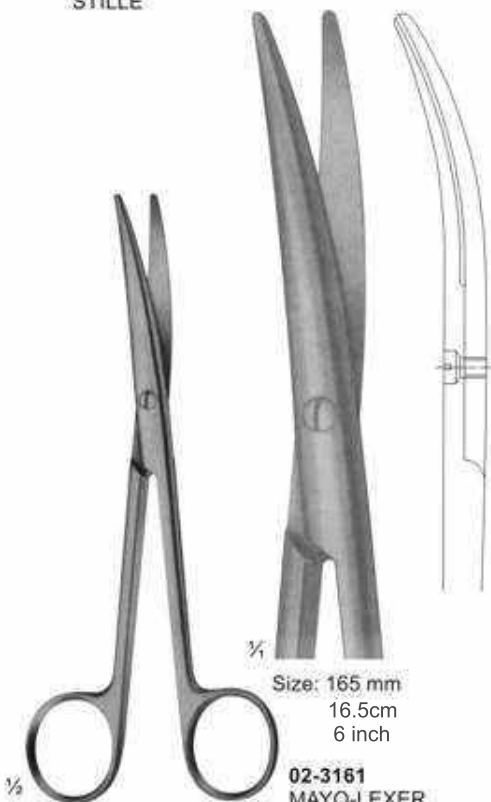

02-3161
Size: 165 mm
16.5cm
6 inch

02-3161
MAYO-LEXER
Standard

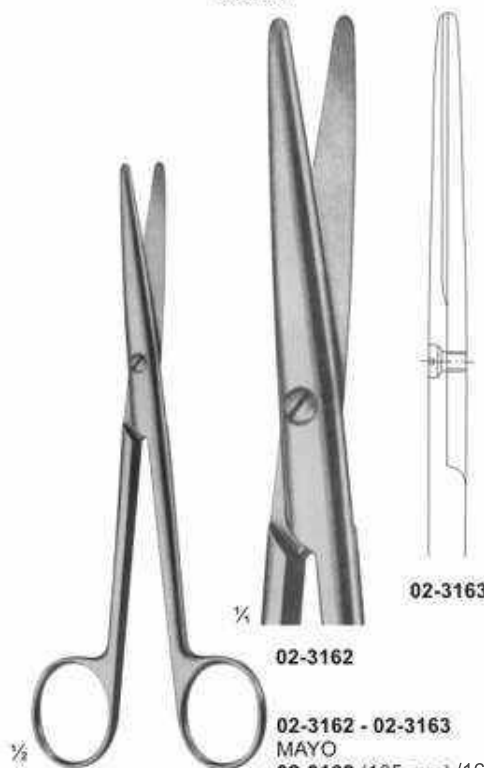

02-3162

02-3162 - 02-3163

MAYO
02-3162 (165 mm) / 16.5cm / 6 inch
02-3163 (200 mm) / 20cm / 8 inch



MAYO
02-3164
Size: 165 mm / 16.5cm
6 inch

02-3165
Size: 200 mm / 20cm
02-3166
Size: 210 mm / 21cm

Dissecting Scissors

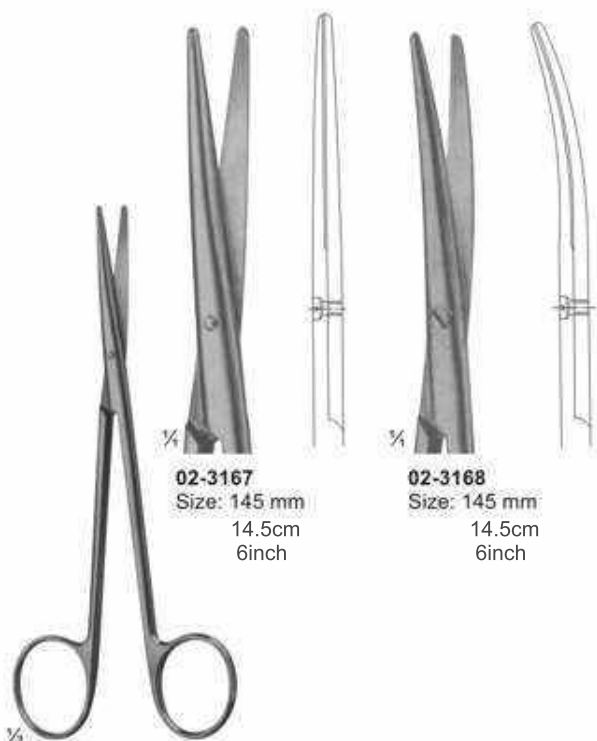

02-3167
 Size: 145 mm
 14.5cm
 6inch

02-3168
 Size: 145 mm
 14.5cm
 6inch

02-3167 - 02-3168
 BABY - METZENBAUM

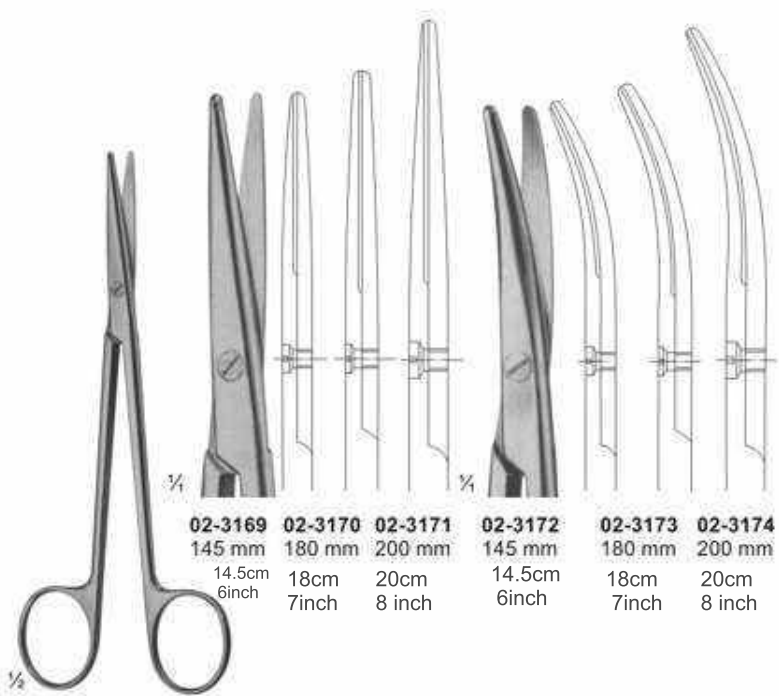

02-3169
 145 mm
 14.5cm
 6inch

02-3170
 180 mm
 18cm
 7inch

02-3171
 200 mm
 20cm
 8 inch

02-3172
 145 mm
 14.5cm
 6inch

02-3173
 180 mm
 18cm
 7inch

02-3174
 200 mm
 20cm
 8 inch

02-3169- 02-3174
 METZENBAUM



02-3175 - 02-3182
 NELSON
 METZENBAUM

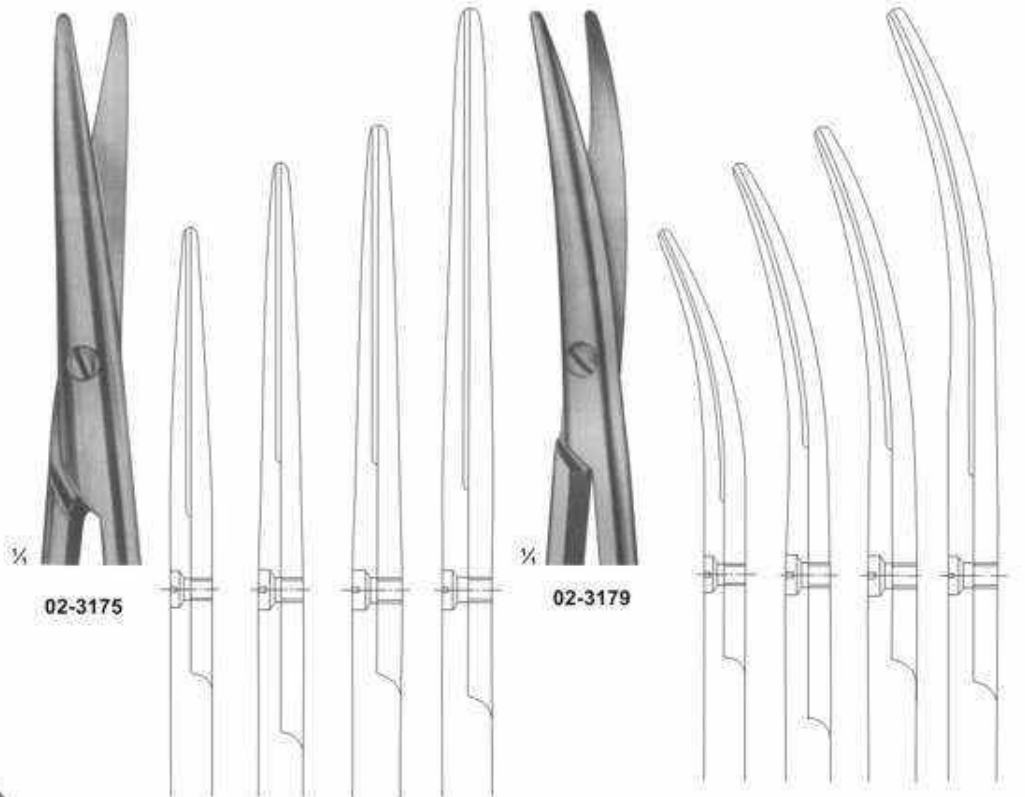

02-3175

02-3179

02-3175
 230 mm
 23cm
 9inch

02-3176
 250 mm
 25cm
 10inch

02-3177
 280 mm
 28cm
 11inch

02-3178
 305 mm
 30.5cm
 12 inch

02-3179
 230 mm
 23cm
 9 inch

02-3180
 250 mm
 25cm
 10 inch

02-3181
 280 mm
 28cm
 11 inch

02-3182
 305 mm
 30.5cm
 12 inch

Vessel Scissors

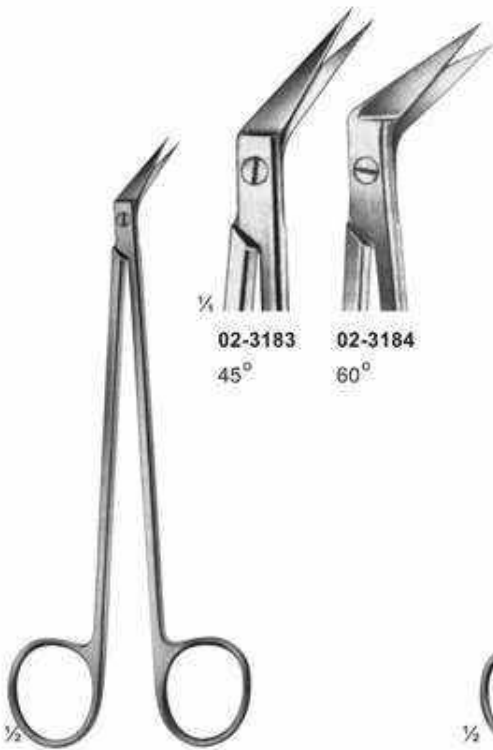

02-3183
45°

02-3184
60°

02-3183 - 02-3184
 DE BAKHEY
 Size: 155 mm
 15.5cm
 6 inch

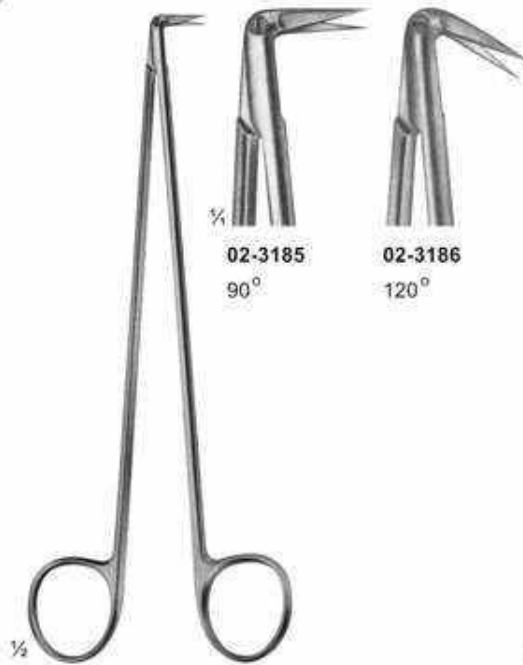

02-3185
90°

02-3186
120°

02-3185 - 02-3186
 DIETRICH
 Size: 170 mm
 17cm
 7 inch

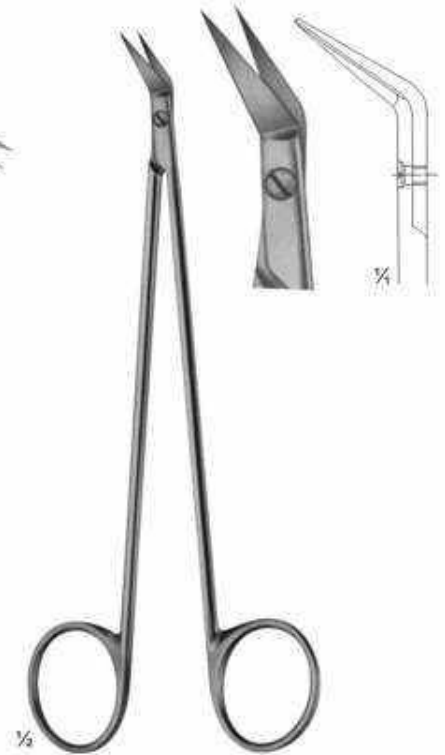

02-3187
 POTTS-SMITH
 Size: 180 mm
 55° Angled on Flat



02-3188
60°

02-3188
 POTTS-SMITH
 Size: 180 mm
 18cm
 7 inch

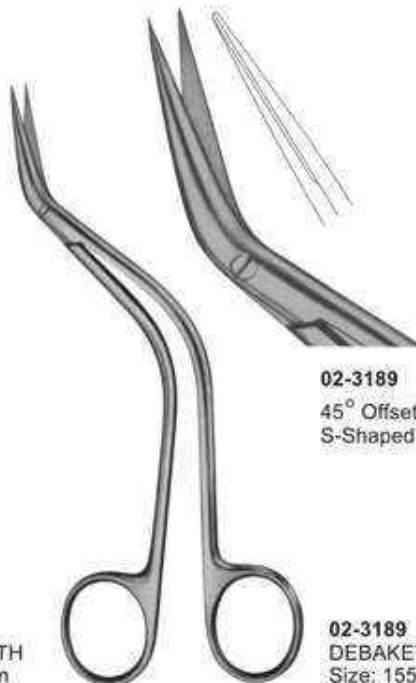

02-3189
 45° Offset Scissors
 S-Shaped

02-3189
 DEBAKEY
 Size: 155 mm
 15.5cm
 6 inch



02-3190
55°

02-3190
 FAVOLORO
 Coronary Artery
 Scissors
 Size: 140 mm
 14cm
 6 inch

Cardiovascular and Neuro-Surgery Scissors



02-3191
OLIVECRONA
Dura Scissors



02-3192
STRULLY
Pointed
Size: 220 mm
22cm
9 inch

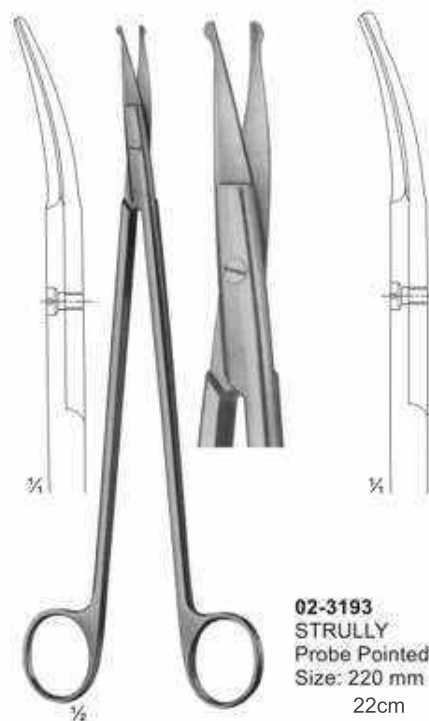

02-3193
STRULLY
Probe Pointed
Size: 220 mm
22cm
9 inch

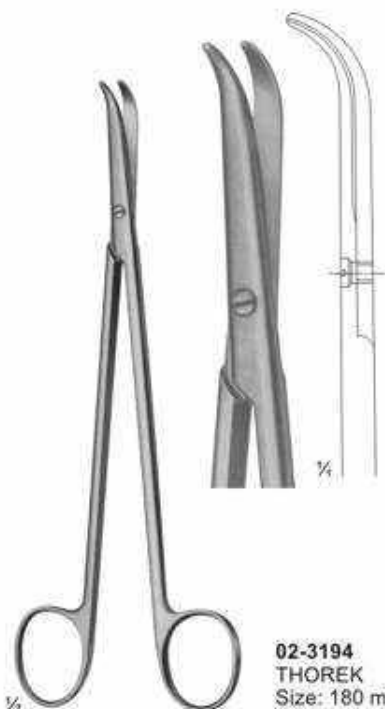

02-3194
THOREK
Size: 180 mm
18cm
7inch

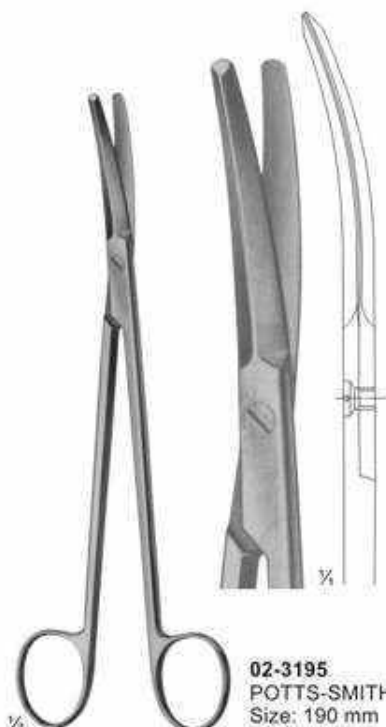

02-3195
POTTS-SMITH
Size: 190 mm
19cm
7inch

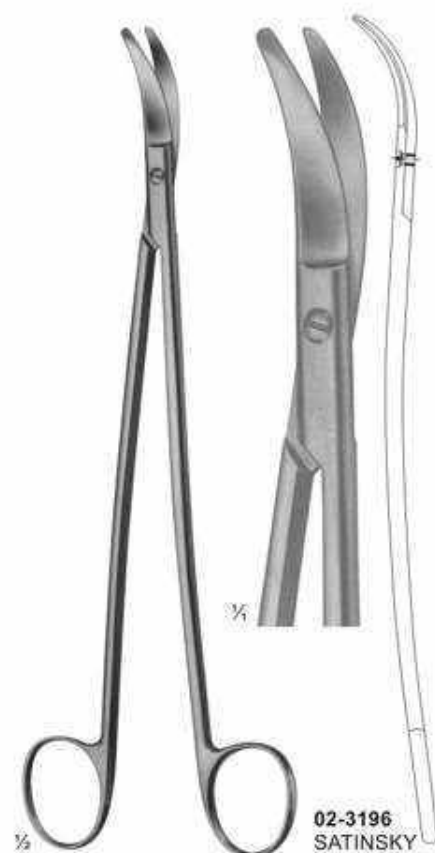

02-3196
SATINSKY
Size: 245 mm 24.5cm
7inch

Delicate, Nasal and Tonsil Scissors



02-3197
1 Finely Toothed Blade
Size: 130 mm /13cm /5 inch

02-3198
LOCKLIN
Curved Sideways,
1 Toothed Blade
Size: 155 mm /15.5cm /6 inch

02-3199
FOMON
Blades Serrated
Size: 145 mm /14.5cm /6 inch

02-3200
COTTLE
Size: 165 mm /16.5cm /6 inch

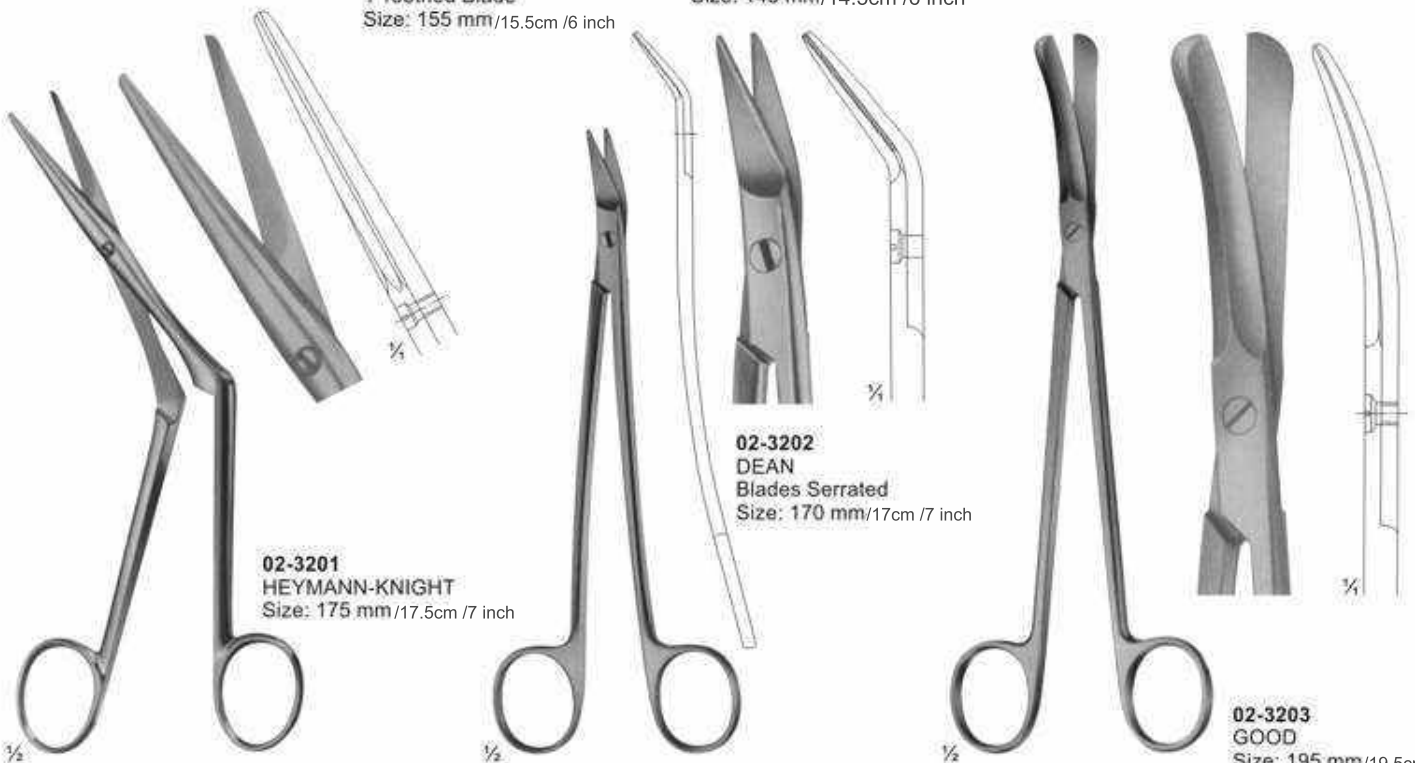

02-3201
HEYMANN-KNIGHT
Size: 175 mm /17.5cm /7 inch

02-3202
DEAN
Blades Serrated
Size: 170 mm /17cm /7 inch

02-3203
GOOD
Size: 195 mm /19.5cm /8inch

Bone Shears



02-3204
 KILLIAN
 Size: 200 mm
 20cm
 8 inch



02-3205 - 02-3206



02-3205
 195 mm
 19.5cm
 8 inch



¼



02-3206
 225 mm
 25.5cm
 10 inch



¼

Operating and Gynaecology Scissors

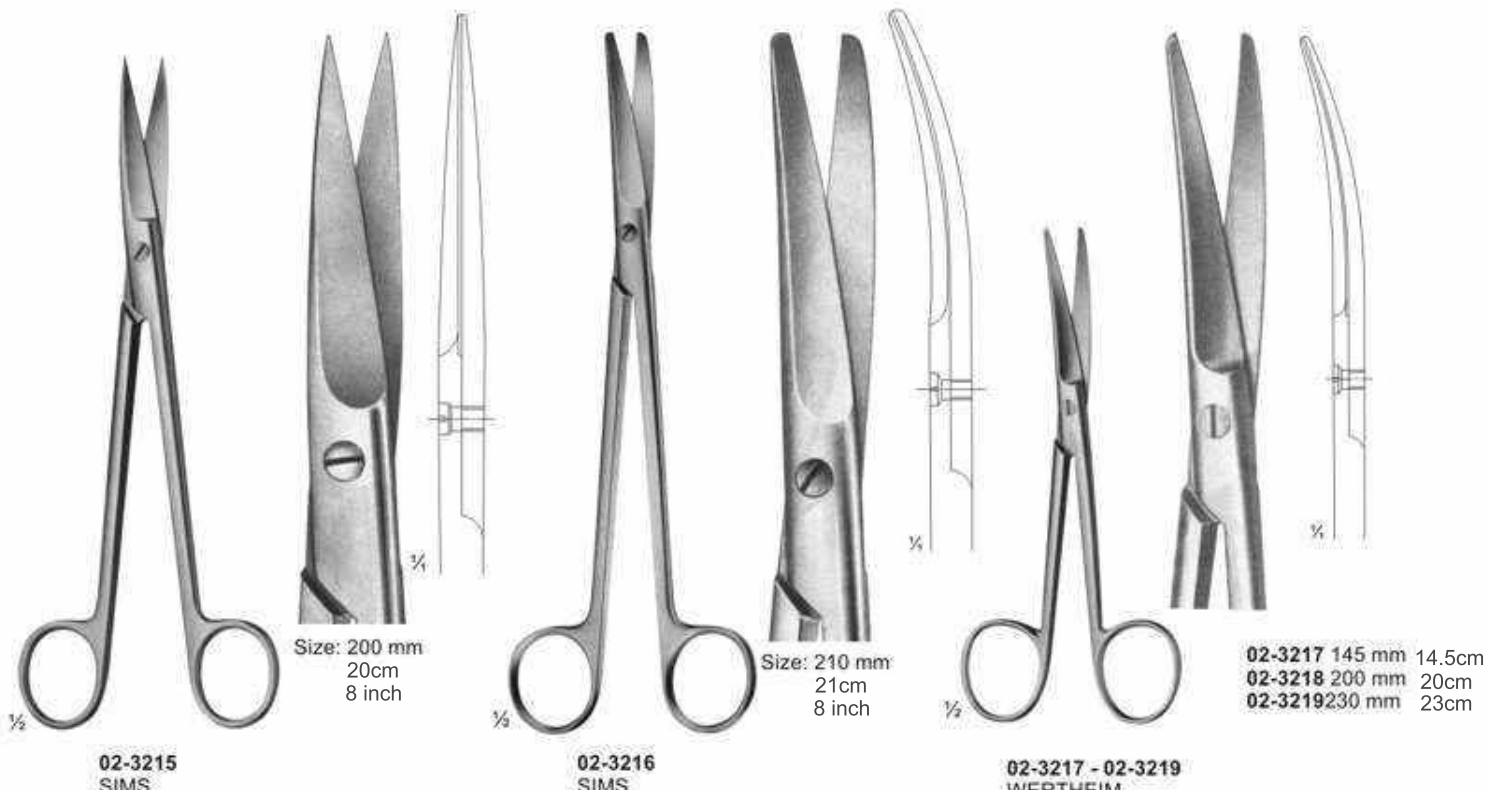
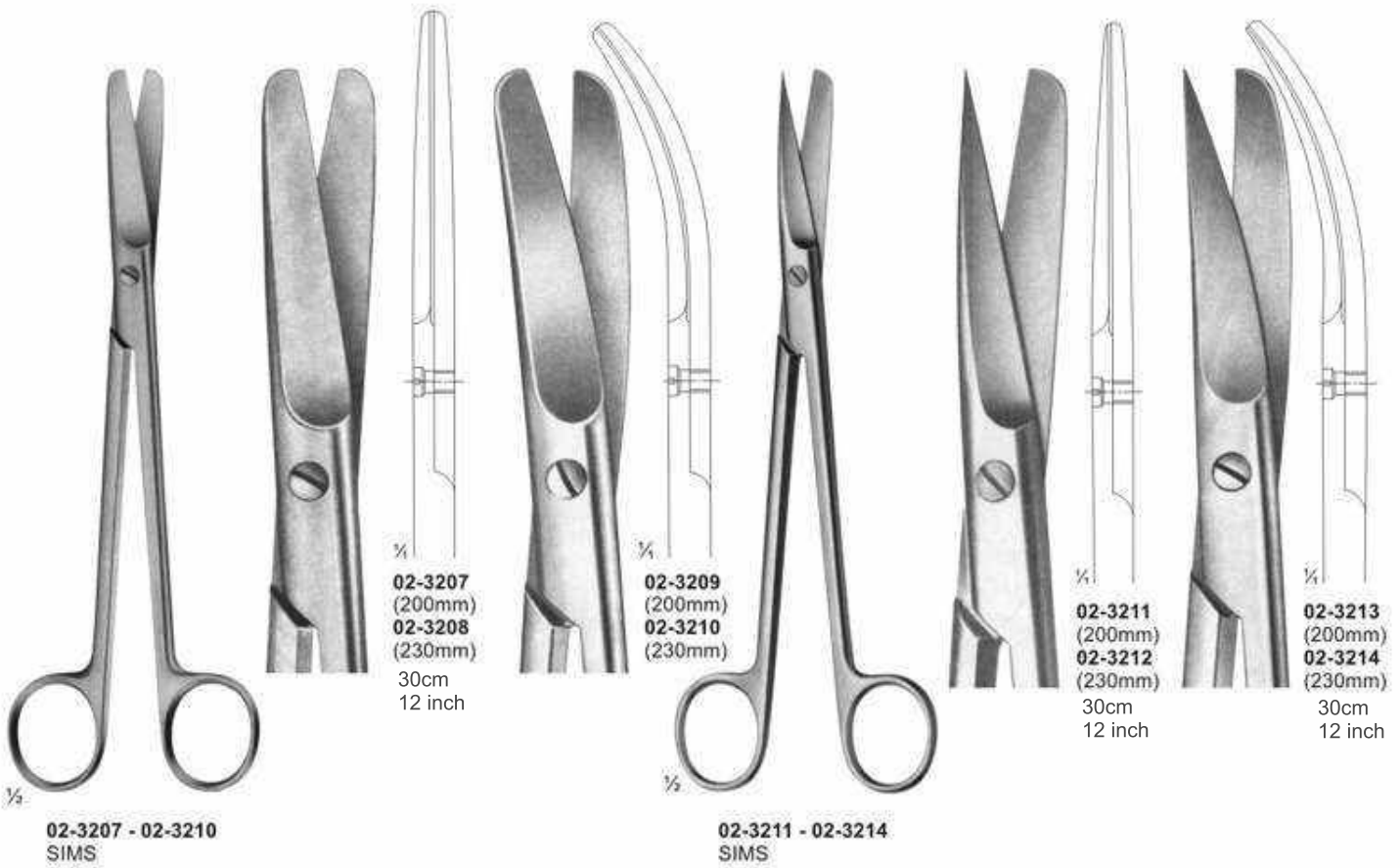

Operating and Gynaecology Scissors

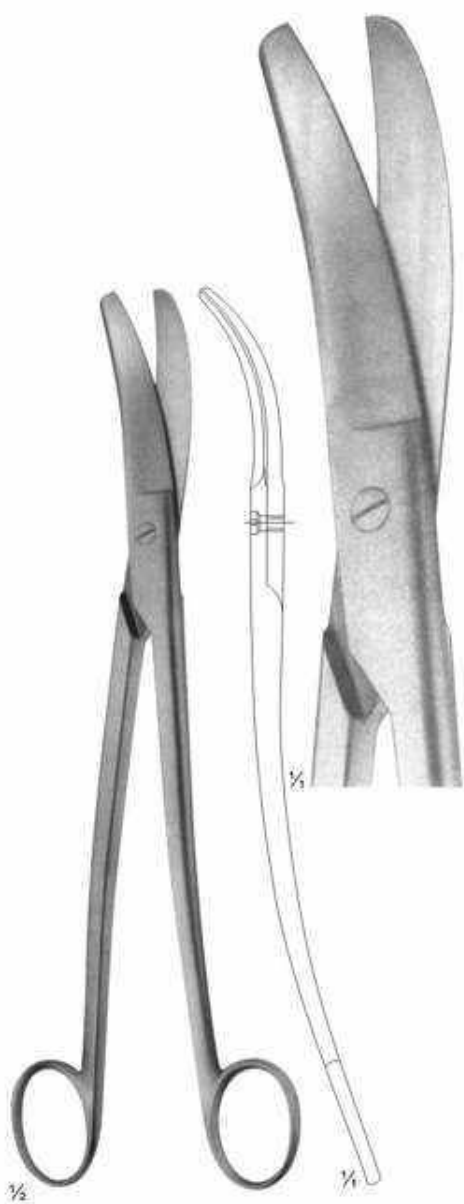

02-3220
SIEBOLD
 Uterine Scissors
 Size: 245 mm
 24.5cm
 10inch

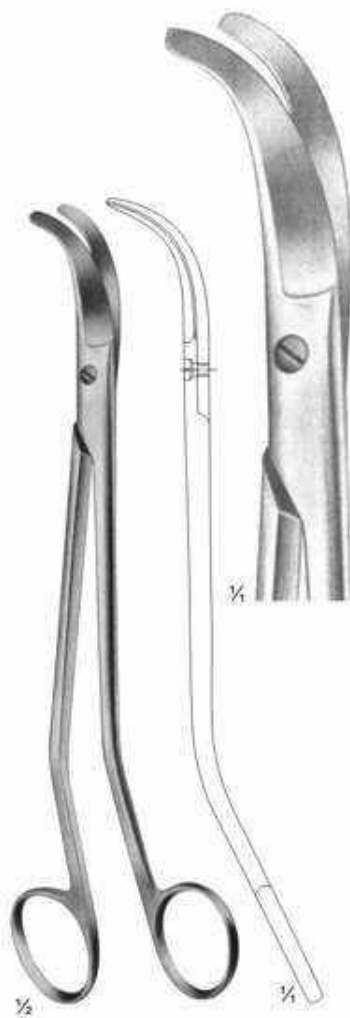

02-3221
BOZEMANN
 Uterine Scissors
 Size: 220 mm
 22cm
 9inch

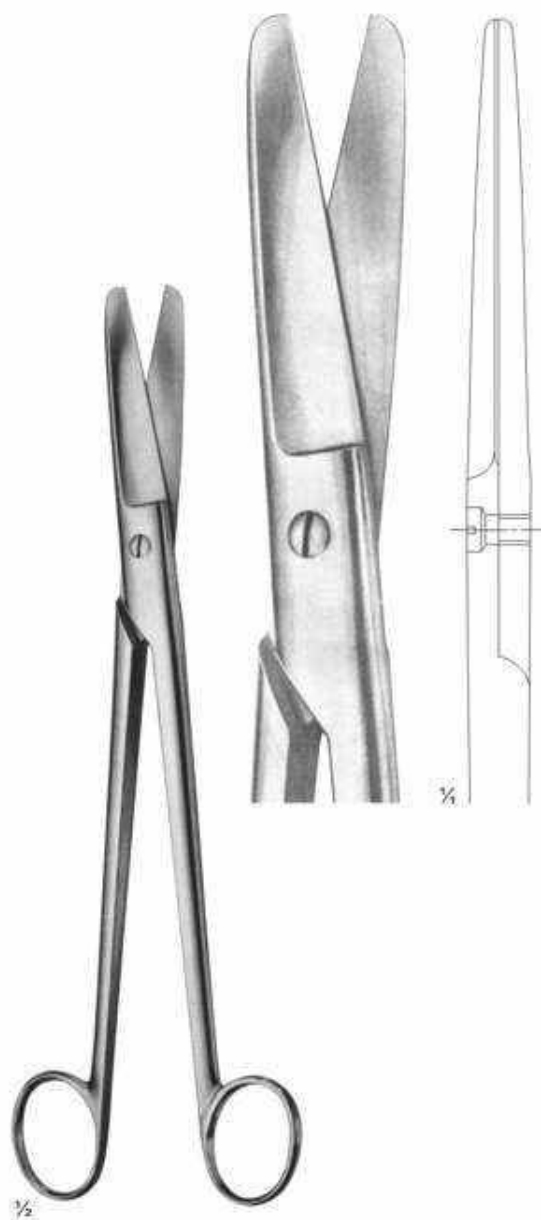

02-3222
SIMS-SIEBOLD
 Uterine Scissors
 Size: 250 mm
 25cm
 10inch

Scissors For Obstetrics



02-3223
SCHUMACHER
Umbilical Cord Scissors
Size: 155 mm
15.5cm
6inch



02-3224
Umbilical Cord Scissors
Size: 105 mm
10.5cm
4inch

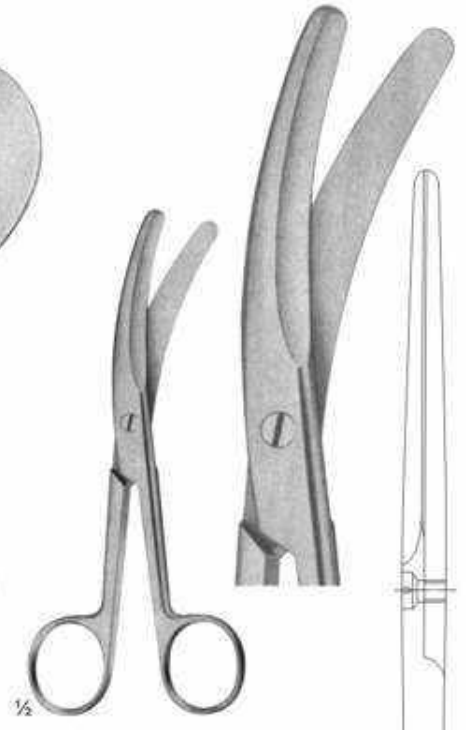

02-3225
Umbilical Cord Scissors



135 mm
13.5cm
6inch

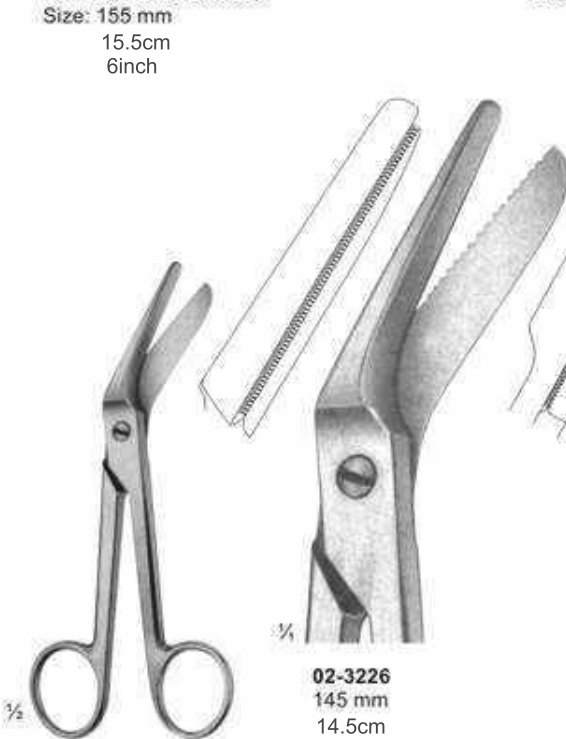

02-3226 - 02-3227
BRAUN-STADLER
Episiotomy Scissors

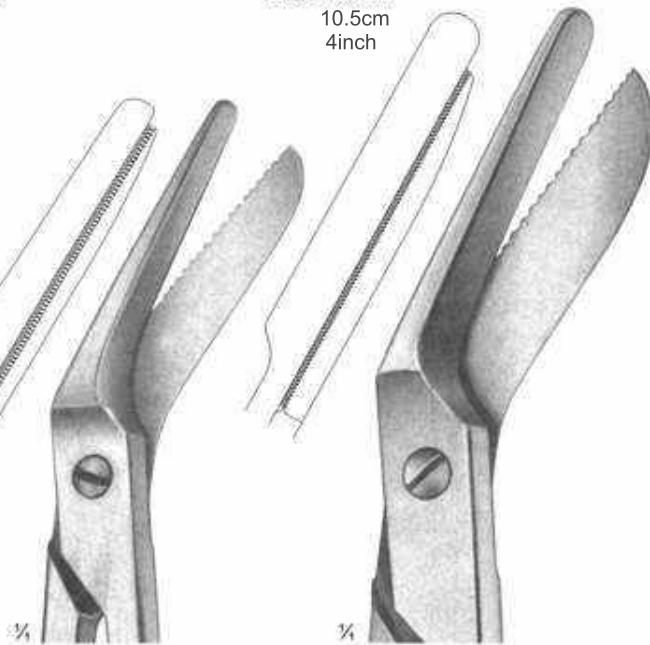

02-3226
145 mm
14.5cm
6inch

02-3227
200 mm
20cm
8 inch

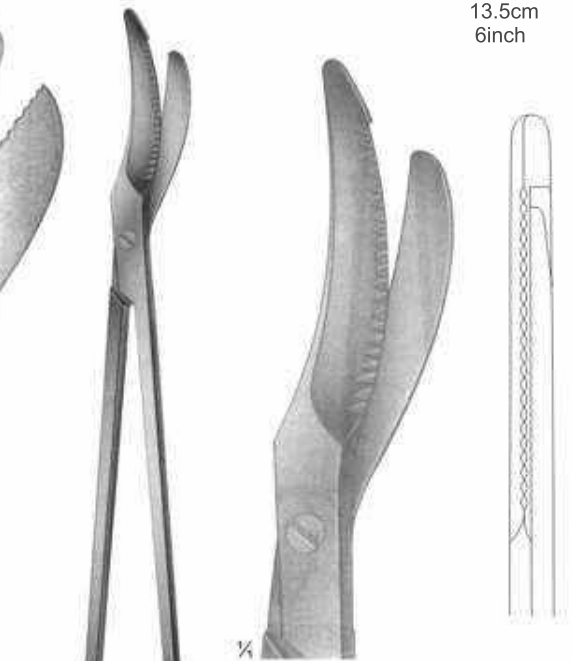

02-3228
Episiotomy Scissors
240 mm
24cm
10inch



Bowel Scissors, Rectal Scissors

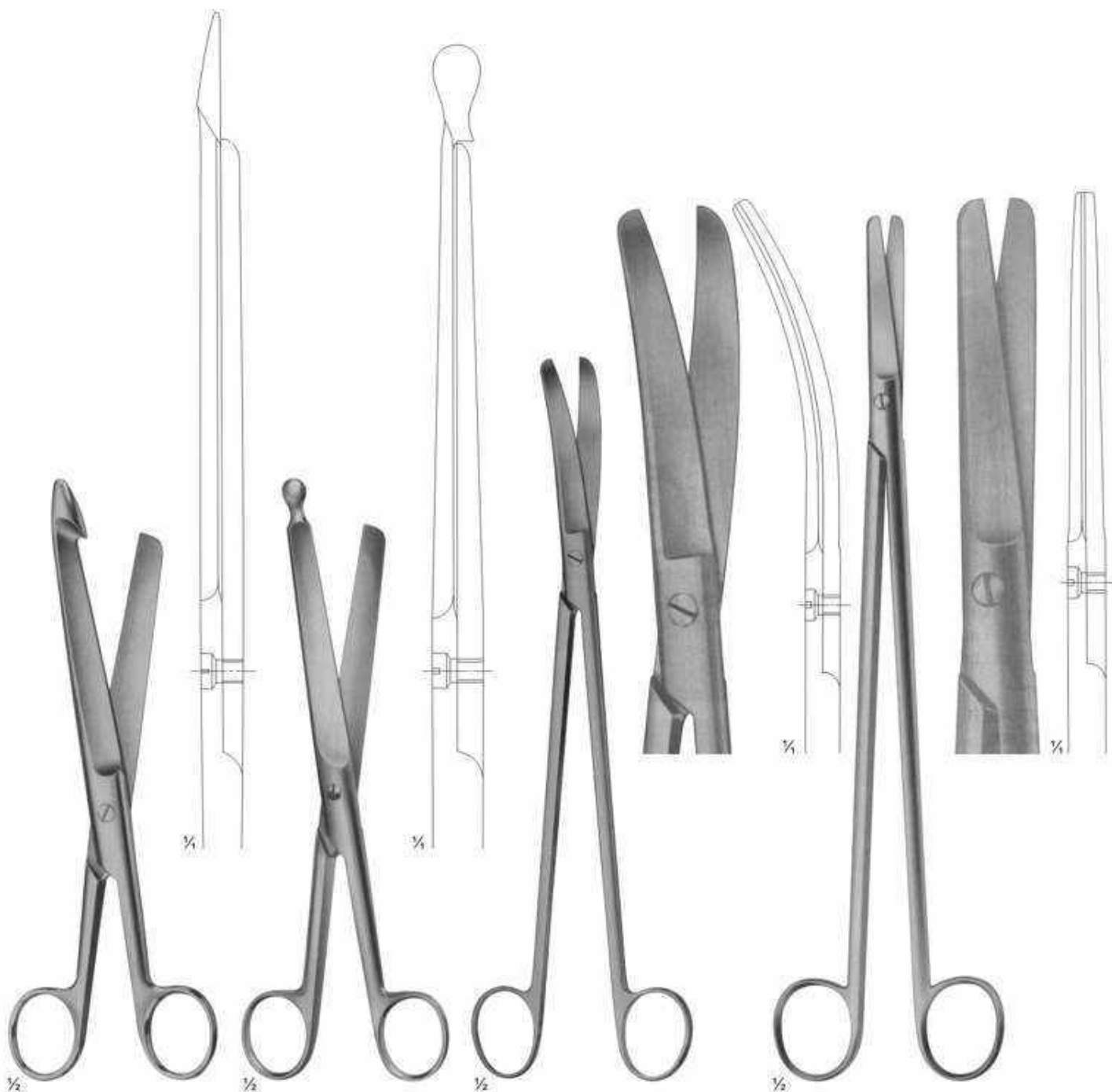

02-3229
Bowel Scissors
Size: 210 mm
21cm
8inch

02-3230
Bowel Scissors
Size: 210 mm
21cm
8inch

02-3231
LLOYD-DAVIES
(GOLIGHER'S)
Rectal Scissors
Size: 270 mm
27cm
11inch

02-3232
STELZNER
Rectal Scissors
Size: 310 mm
31cm
12inch

Ligature Scissors



02-3233 - 02-3234
SPENCER

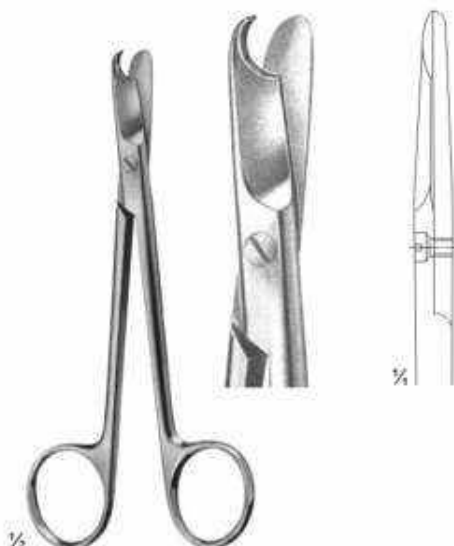

02-3235
LITTAUER
 Size: 135 mm
 13.5cm
 5inch

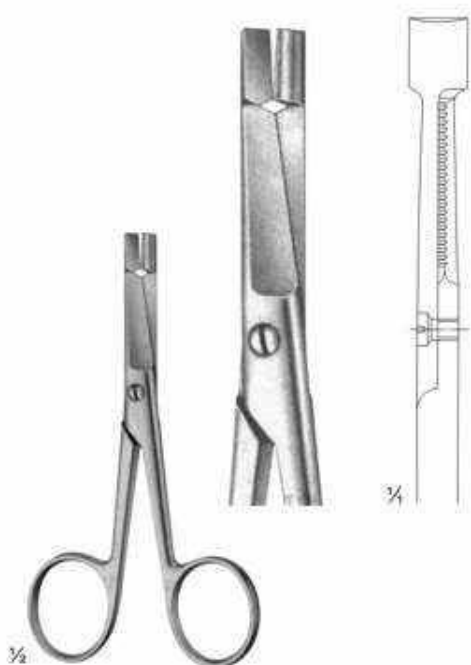

02-3236
EISELSBERG
 Size: 115 mm
 11.5cm
 4inch

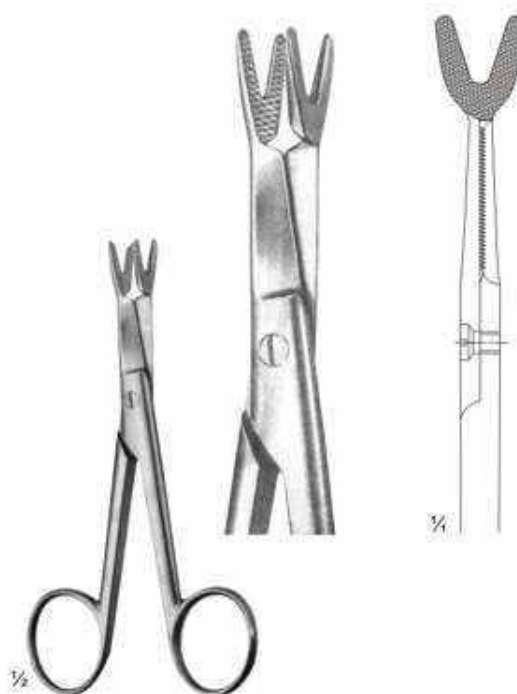

02-3237
SCHOEMAKER-LOTH
 Size: 125 mm
 12.5cm
 5inch

Wire and Plate Scissors

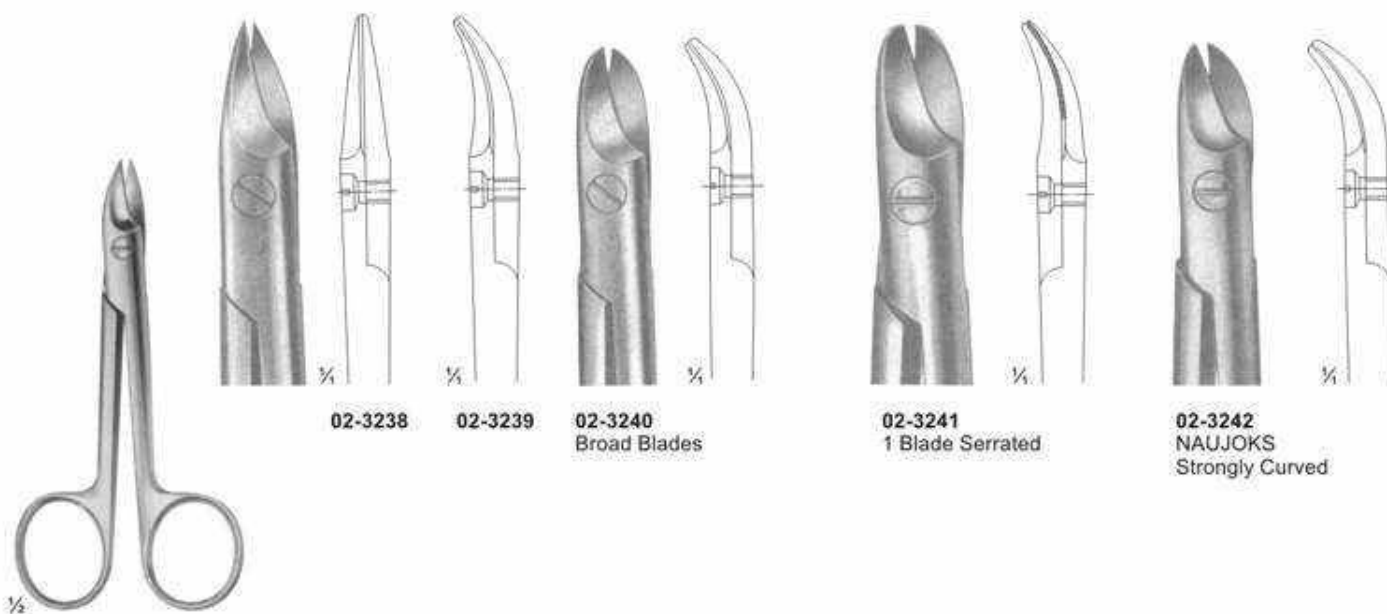

02-3238

02-3239

02-3240
Broad Blades

02-3241
1 Blade Serrated

02-3242
NAUJOKS
Strongly Curved

02-3238 - 02-3242

BEEBE

Size: 110 mm

11cm

4inch

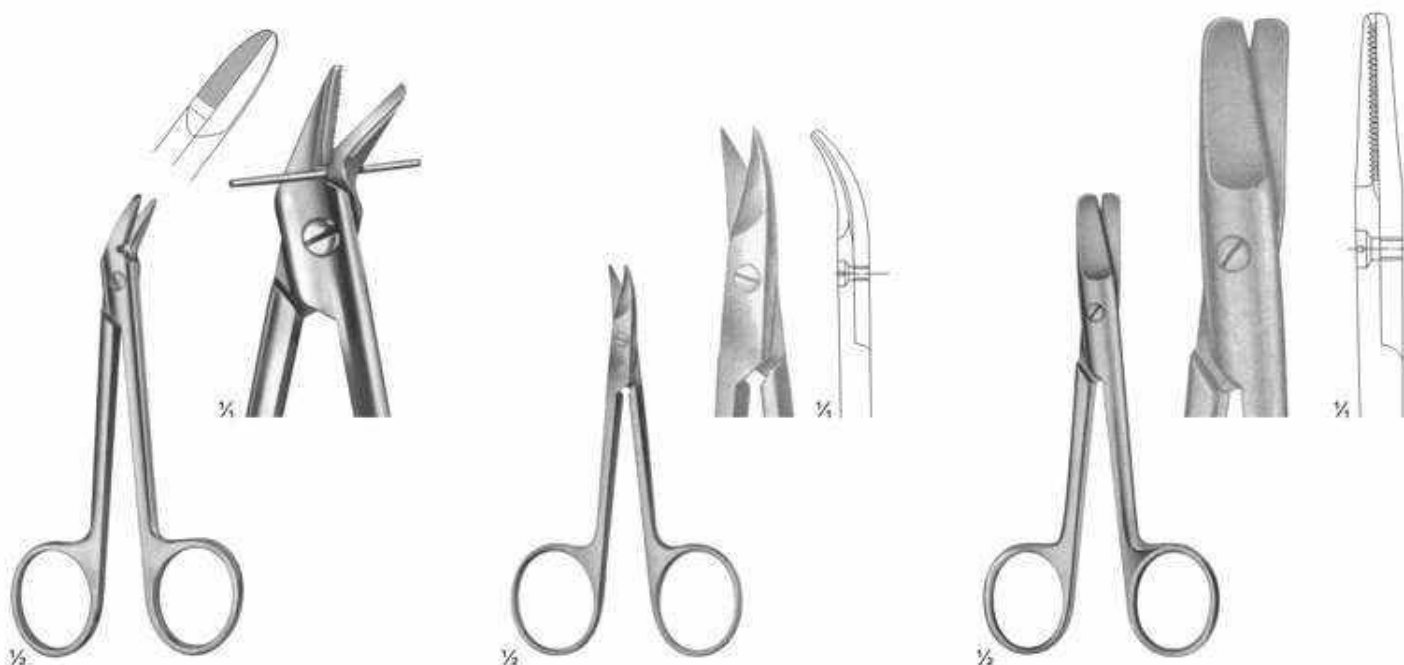

02-3243
1 Blade Serrated

Size: 120 mm

12cm

4inch

02-3244

STRACK

Size: 100 mm

10cm

3inch

02-3245

HARVEY

blades serrated

Size: 125 mm

12.5cm

4inch

Nail and Bandage Scissors

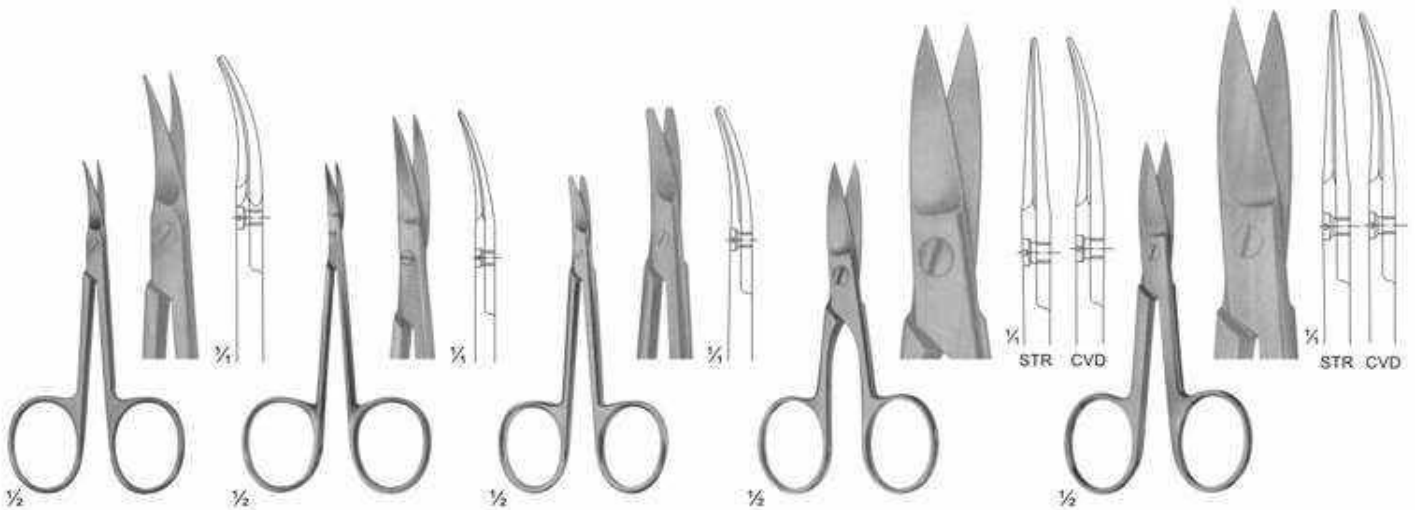

02-3246
NAIL SCISSORS
 Size: 90 mm
 9cm
 4inch

02-3247
NAIL SCISSORS
 especially fine pattern.
 Size: 90 mm
 9cm
 4inch

02-3248
BABY NAIL
SCISSORS
 Size: 85 mm
 8.5cm
 3inch

02-3249 - 02-3252
NAIL SCISSORS
02-3249(90mm)straight 9cm
02-3250(90mm)curved 9cm
02-3251(100mm)straight 10cm
02-3252(110mm)curved 10cm

02-3253 - 02-3255
NAIL SCISSORS
02-3253(95mm)straight 9.5cm
02-3254(95mm)curved 9.5cm
02-3255(105mm)straight 1.5cm



02-3256
KNOWLES
 Size: 140 mm
 14cm
 6inch

02-3257
KNOWLES
 Size: 145 mm
 14.5cm
 6inch

02-3258
 Size: 150 mm
 15cm
 6inch

02-3259
SMITH
 Size: 180 mm
 18cm
 7inch

02-3260
BANDAGE CUTTING
SCISSORS
 Size: 310 mm
 31cm
 12inch

Bandage and Cloth Scissors



02-3261
 UNIVERSAL BANDAGE & CLOTH SCISSORS,
 WITH TOOTHED EDGES, AUTO CLEAVABLE up to 143 °C
 180 mm /18cm /7inch



02-3262
 LISTER BANDAGE & CLOTH
 SCISSORS, WITH TOOTHED EDGES,
 AUTO CLEAVABLE up to 143 °C
 Size: 145 mm/14.5cm /6inch

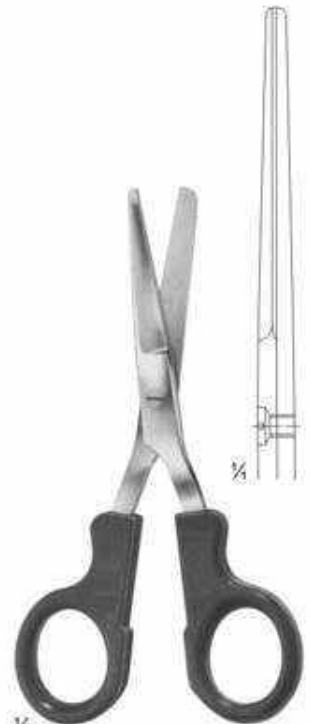

02-3263
 NURSE'S SCISSORS
 Size: 145 mm /14.5cm /6inch
 AUTO CLEAVABLE up to 143 °C

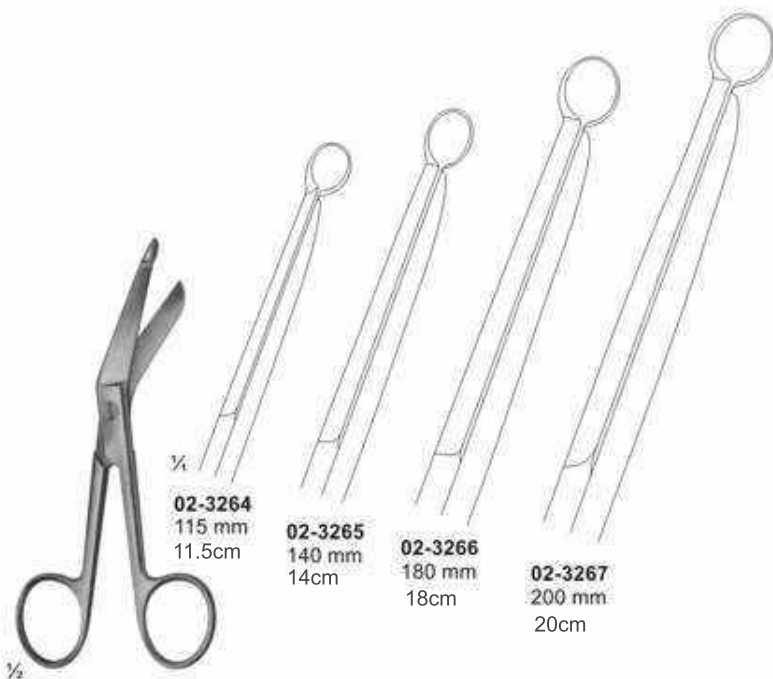

02-3264 115 mm /11.5cm
02-3265 140 mm /14cm
02-3266 180 mm /18cm
02-3267 200 mm /20cm

02-3264 - 02-3267
 LISTER

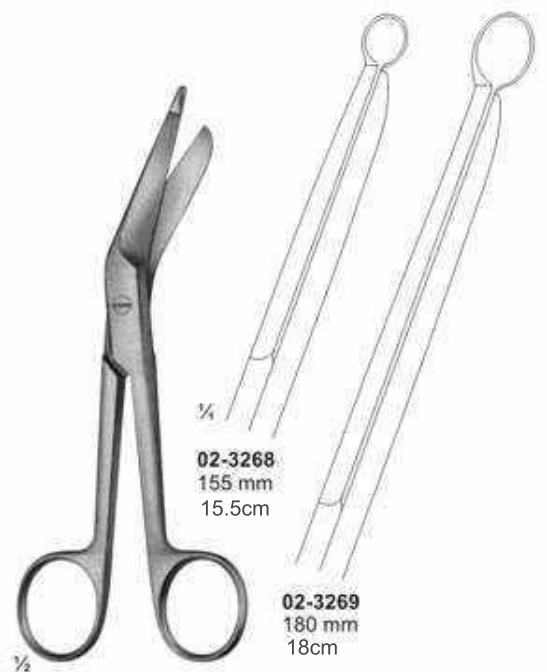

02-3268 155 mm /15.5cm
02-3269 180 mm /18cm

02-3268 - 02-3269
 LISTER

Bandage, Cloth and Plaster Scissors



02-3270
CLOTH SCISSORS
205 mm 20.5cm/8inch

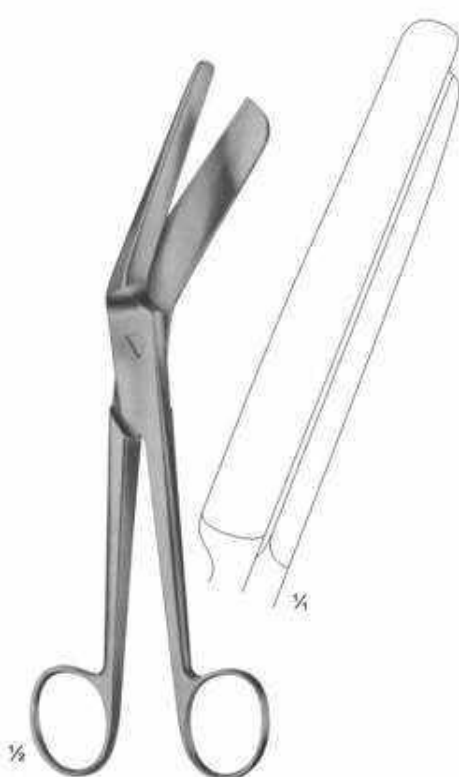

02-3271
BRAUN-STADLER
Bandage scissors
225 mm 22.5cm



02-3272
SEUTIN
Plaster scissors
230 mm 23.5cm/9inch



02-3273 - 02-3274
ESMARCH (Plaster scissors)

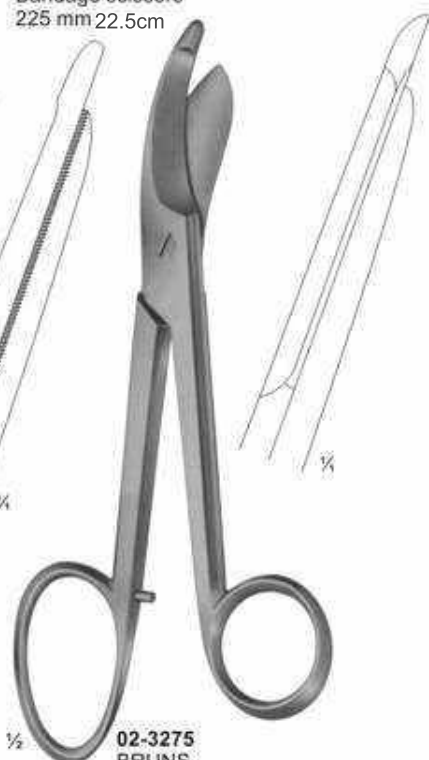

02-3275
BRUNS
Plaster scissors
235 mm
23.5cm
9 inch



02-3276
BANDAGE SCISSORS
235 mm
23.5cm
9 inch

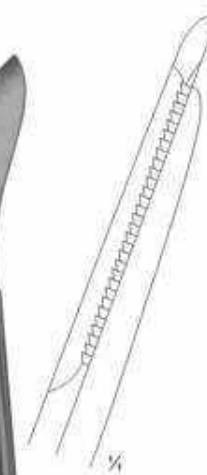

Micro Forceps, Jeweler Types and Micro Suture Typing Forceps

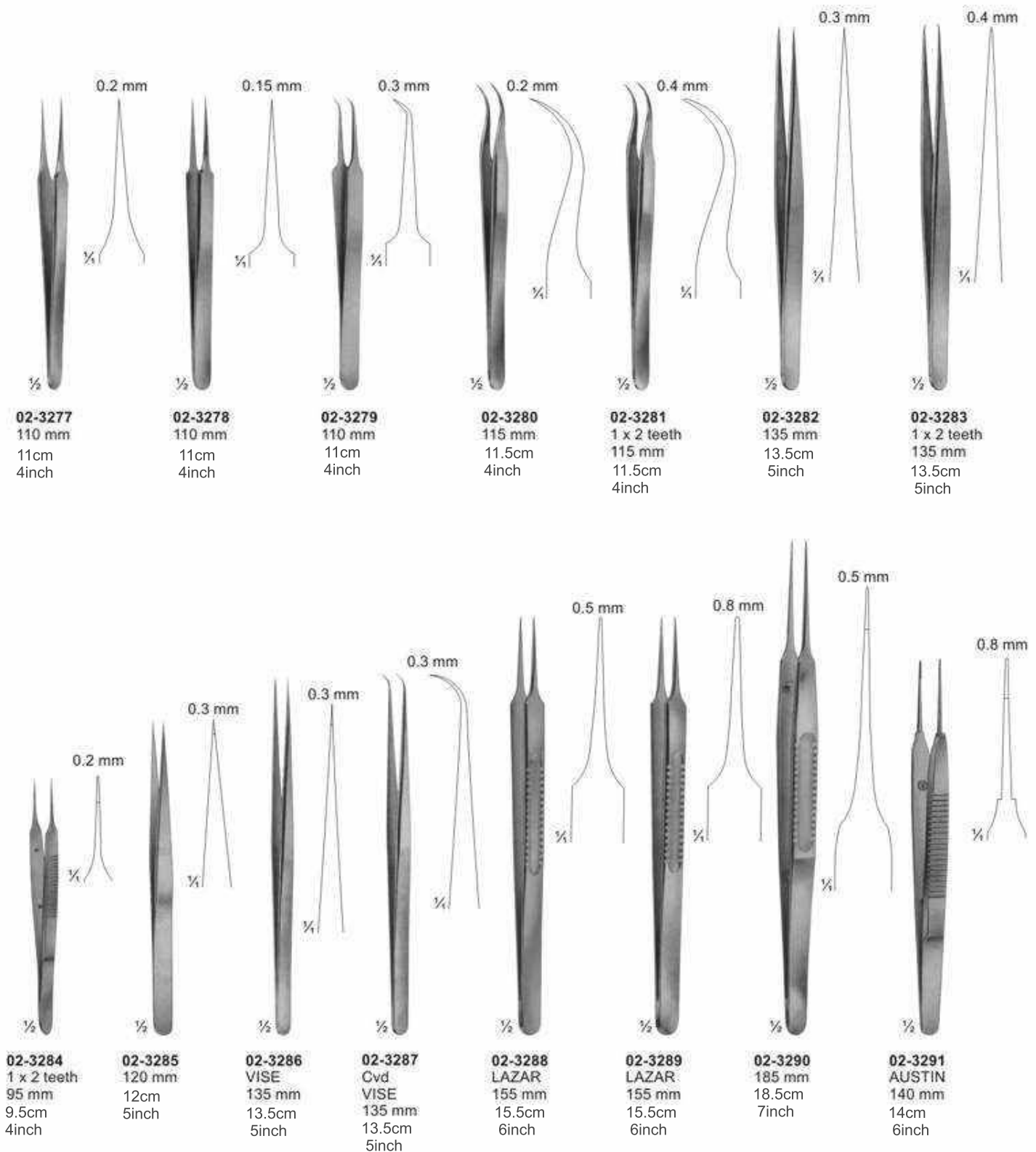

Micro Forceps, Jeweler Types and Micro Suture Typing Forceps

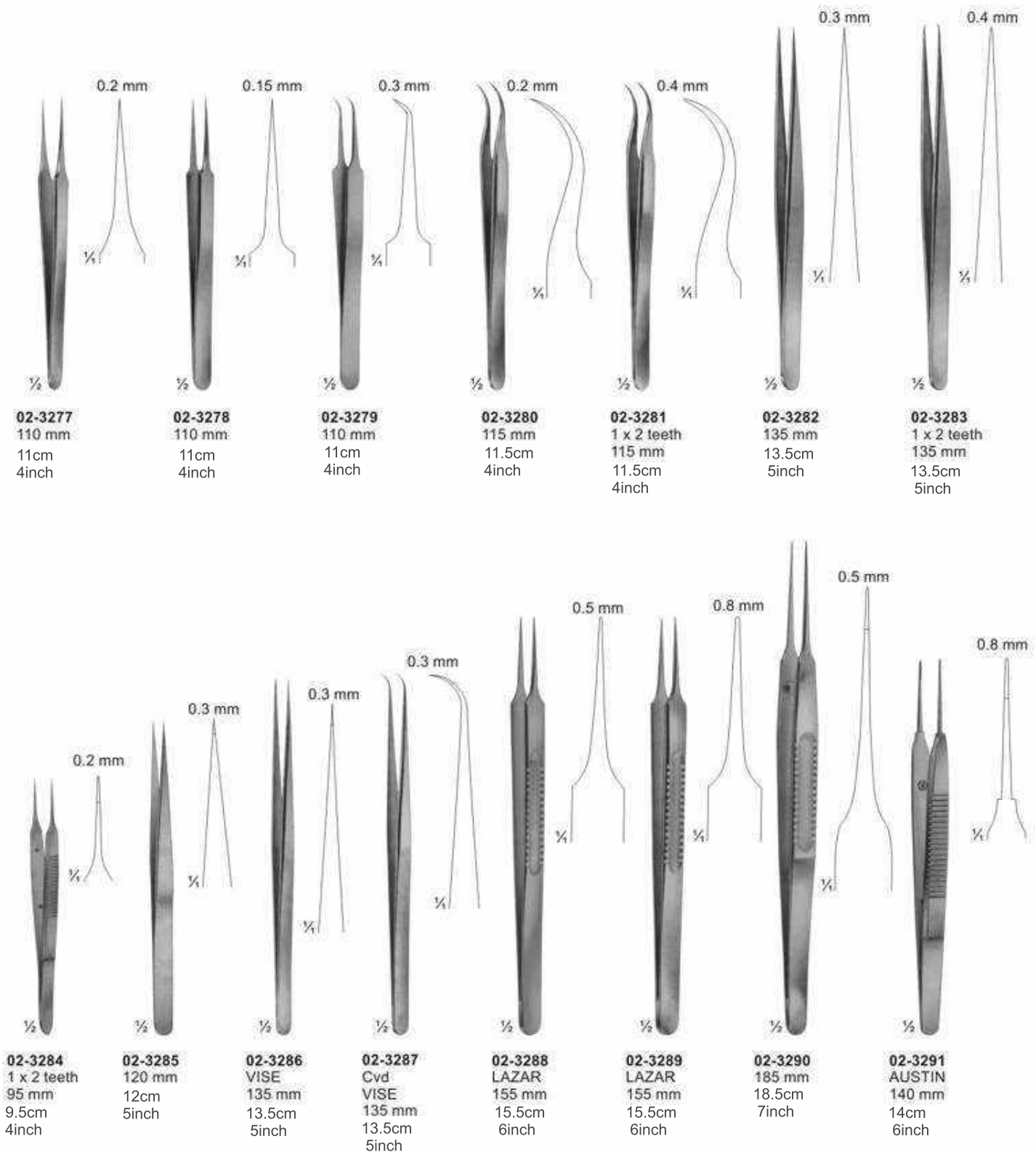

Forceps for Grasping Tissue, Tumors,
Bayonet Shaped



02-3312 - 02-3314
YASARGIL-SAMII
Jaws Spoon-Shaped
240 mm
24cm
9inch



02-3315 - 02-3316
YASARGIL
Jaws Spoon-Shaped
220 mm
22cm
9inch



02-3317 - 02-3319
SAMII
Jaws Spoon-Shaped
230 mm
23cm
9inch



02-3320 - 02-3322
SAMII
Jaws Spoon-Shaped
230 mm
23cm
9inch

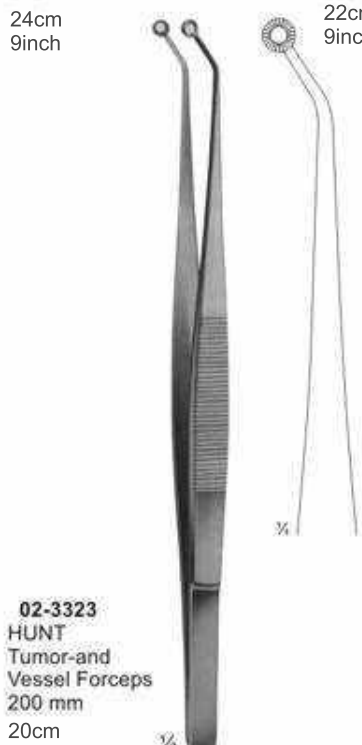

02-3323
HUNT
Tumor-and
Vessel Forceps
200 mm
20cm
8inch



02-3324
HUNT
Tumor-and
Vessel Forceps
200 mm
20cm
8inch

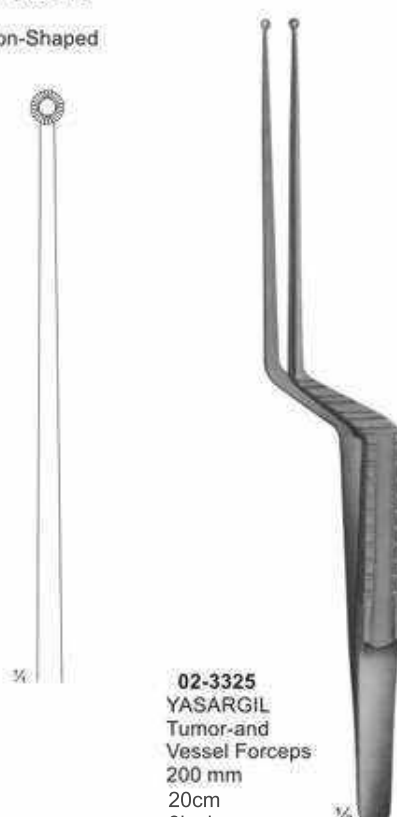

02-3325
YASARGIL
Tumor-and
Vessel Forceps
200 mm
20cm
8inch

Delicate Dissecting, Microscopic,
Sterilizing Forceps



02-3326
THORPE
Corneal forceps
120 mm 12cm
5inch



02-3327
MICRO-ADSON
120 mm 12cm
5inch



02-3328
ADSON
120 mm
12cm
5inch

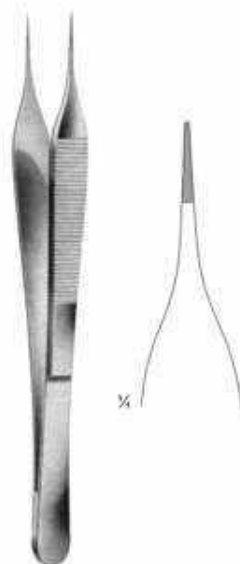

02-3329
MICRO-ADSON
150 mm
15cm
6inch



02-3330 - 02-3332
100 mm
10cm
4inch

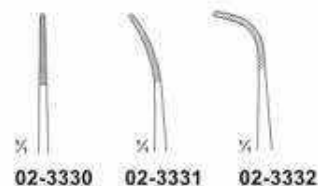

02-3330 **02-3331** **02-3332**

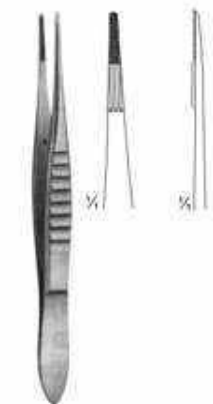

02-3333
BONACCOLTO
110 mm



02-3334
115 mm



02-3335 - 02-3344

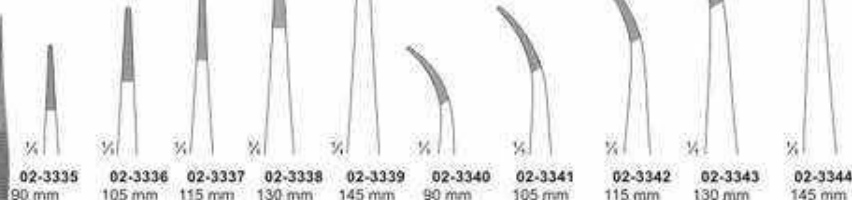

02-3335 90 mm **02-3336** 105 mm **02-3337** 115 mm **02-3338** 130 mm **02-3339** 145 mm **02-3340** 90 mm **02-3341** 105 mm **02-3342** 115 mm **02-3343** 130 mm **02-3344** 145 mm

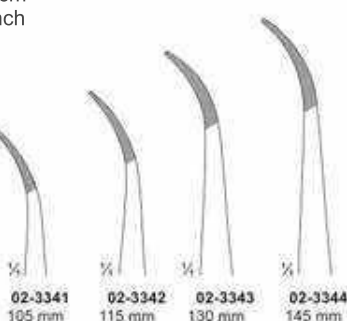

02-3341 105 mm **02-3342** 115 mm **02-3343** 130 mm **02-3344** 145 mm



02-3345
100 mm
10cm
4inch



02-3346
100 mm
10cm
4inch



02-3347
100 mm
10cm
4inch

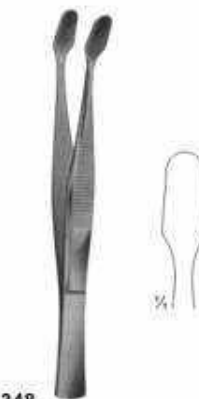

02-3348
KUHNE
Cover glass forceps
105 mm
10.5cm
4inch



02-3349
160 mm
16cm
6inch

Delicate Dissecting Forceps

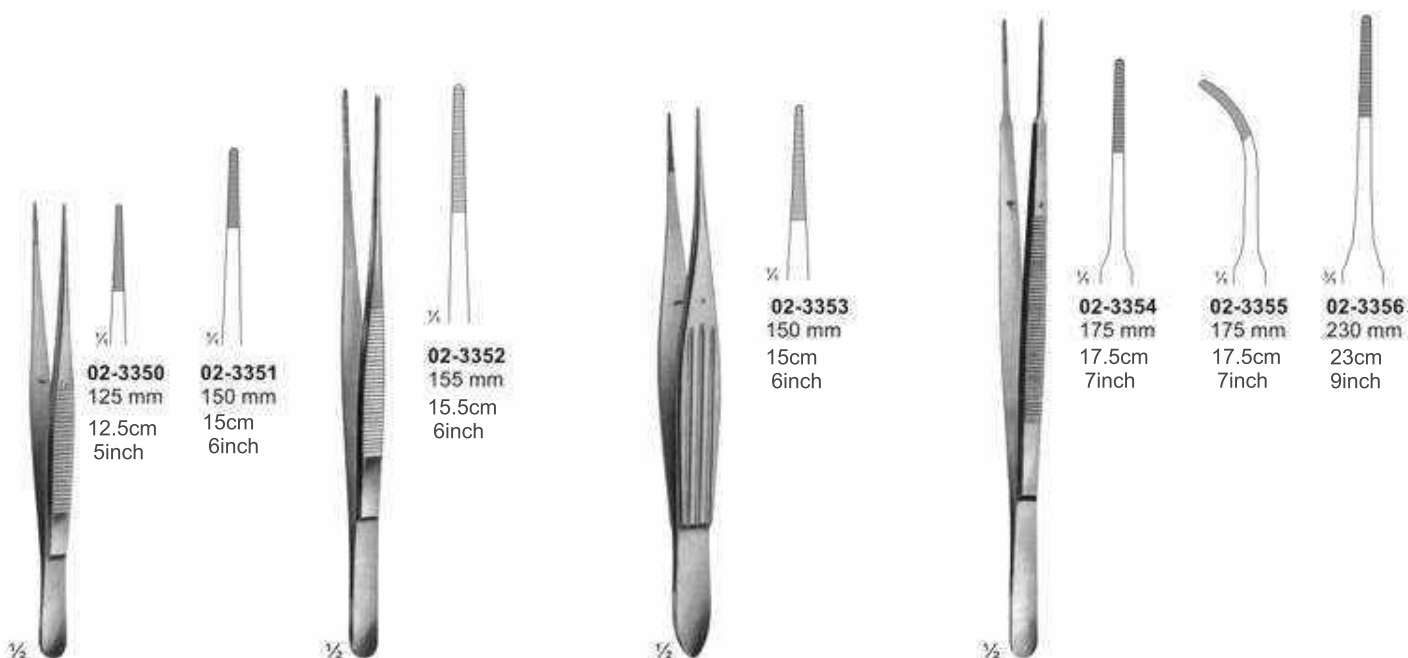

02-3350 - 02-3351
SEMKEN

02-3352

02-3353
MC INDOE

02-3354 - 02-3356
GERALD

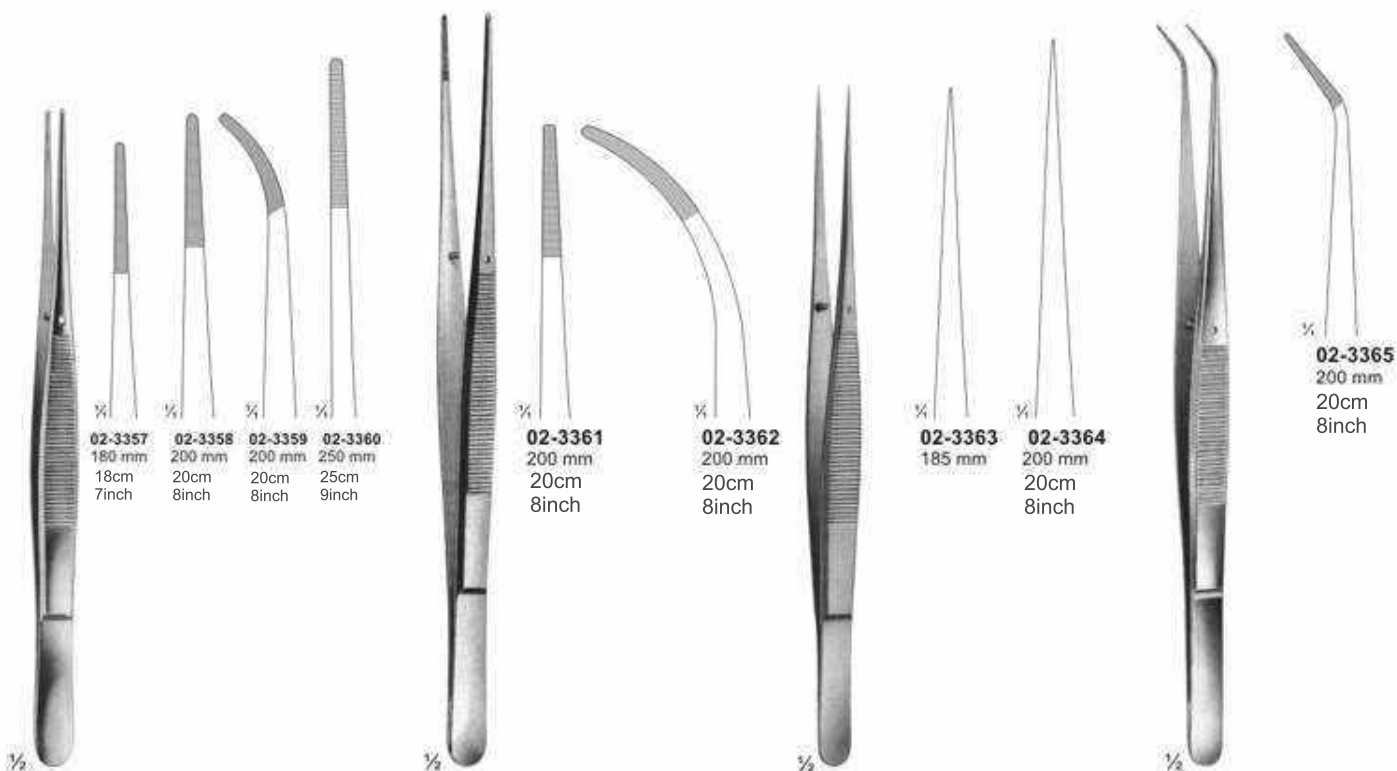

02-3357 - 02-3360
CUSHING

02-3361 - 02-3362
BROPHY

02-3363 - 02-3364
SMOOTH JAWS

02-3365

Dissecting Forceps



02-3366
 115 mm
 11.5cm
 5inch

02-3367
 130 mm
 13cm
 5inch

02-3368
 145 mm
 14.5cm
 6inch

02-3369
 160 mm
 16cm
 7inch

02-3370
 180 mm
 18cm
 7inch

02-3371
 200 mm
 20cm
 9inch

02-3372
 250 mm
 25cm
 10inch

02-3373
 300 mm
 30cm
 12inch

02-3366 - 03-3373
 STANDARD



02-3374
 115 mm
 11.5cm
 5inch

02-3375
 130 mm
 13cm
 5inch

02-3376
 145 mm
 14.5cm
 6inch

02-3377
 160 mm
 16cm
 6inch

02-3378
 305 mm
 30.5cm
 12inch

02-3374 - 03-3378
 MEDIUM



02-3379
 130 mm
 13cm
 5inch



02-3380
 145 mm
 14.5cm
 6inch

02-3379 - 02-3380
 MEDIUM

Dissecting Forceps



02-3381
125 mm
12.5cm
5 inch



02-3382
155 mm
15.5cm
6 inch



02-3383
130 mm
13cm
5inch



02-3384
150 mm
15cm
6 inch



02-3385
170 mm
17cm
7 inch



02-3386
200 mm
20cm
8 inch

02-3381 - 02-3382

02-3383 - 02-3386
Swedish pattern



02-3387
OCHSNER
Ligature forceps
145mm
14.5cm
6inch



02-3388
FRICKE
Artery forceps
130mm
13cm
5inch



03-3389
BONNEY
175mm
17.5cm
7inch

Ultra-Light Forceps ATRAUMATA



02-3390
 150 mm
 15cm
 6 inch

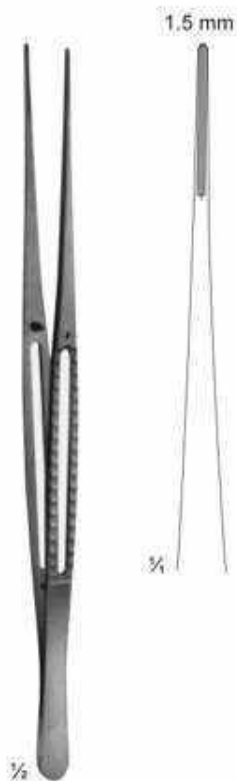

02-3391
 200 mm
 20cm
 8 inch

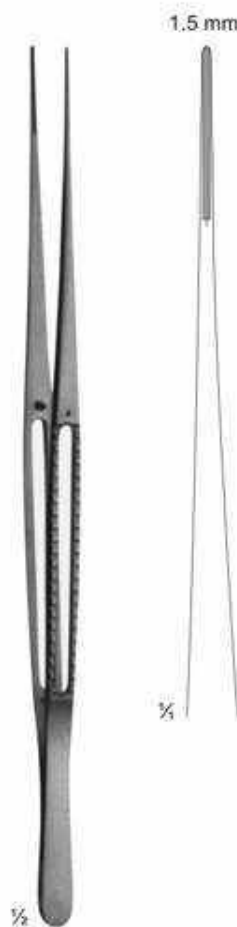

02-3392
 240 mm
 24cm
 9 inch

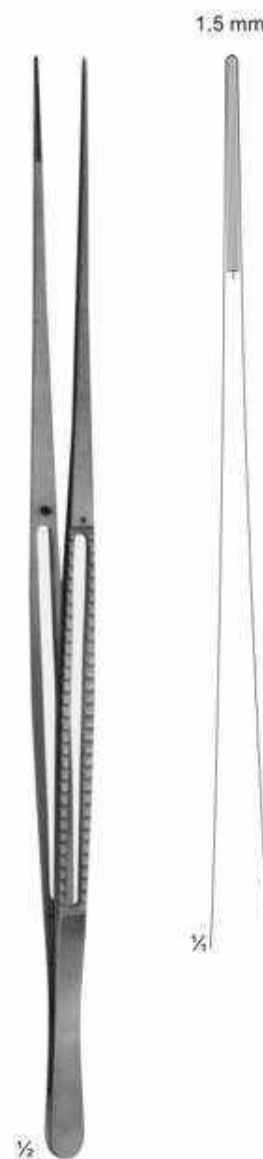

02-3393
 300 mm
 30cm
 12 inch

Forceps ATRAUMATA

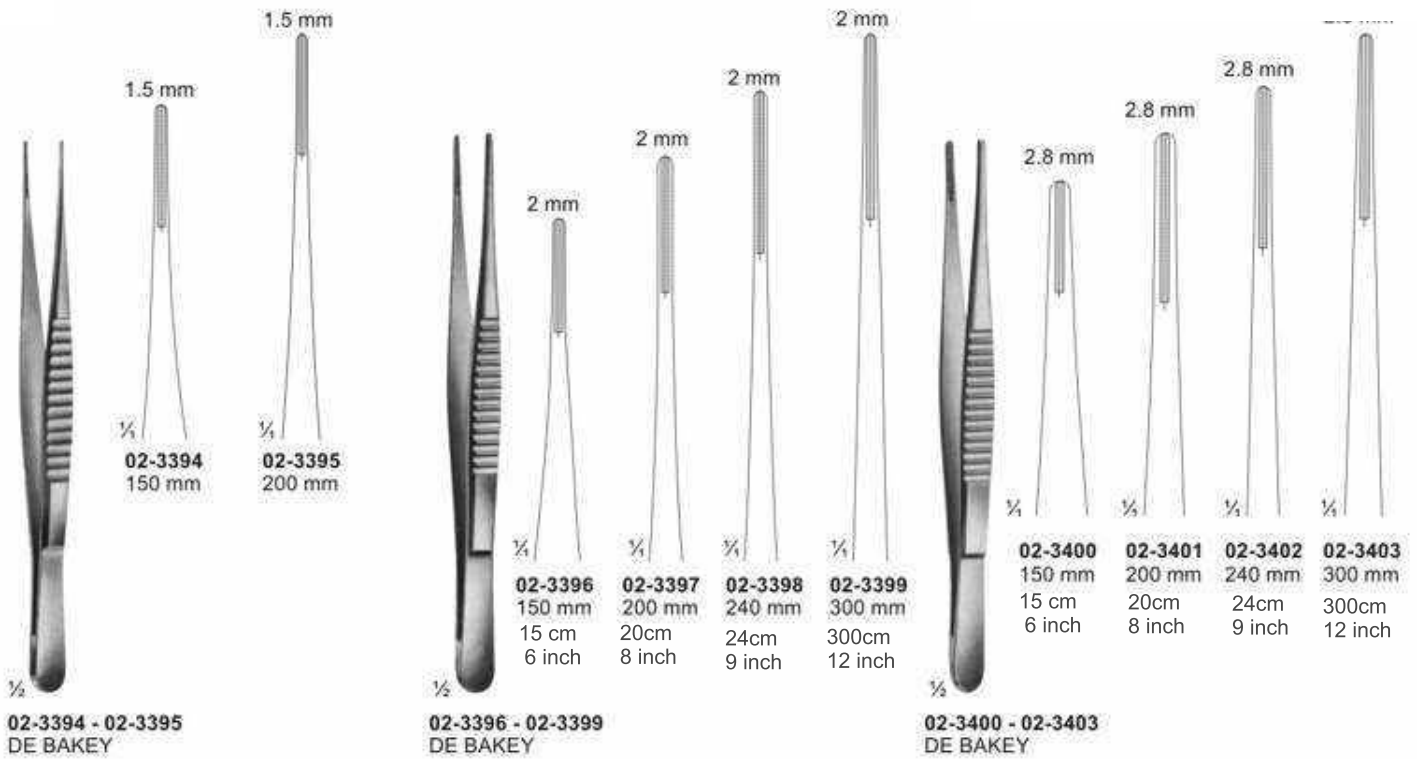

Forceps, Bayonet - Shaped, Angular

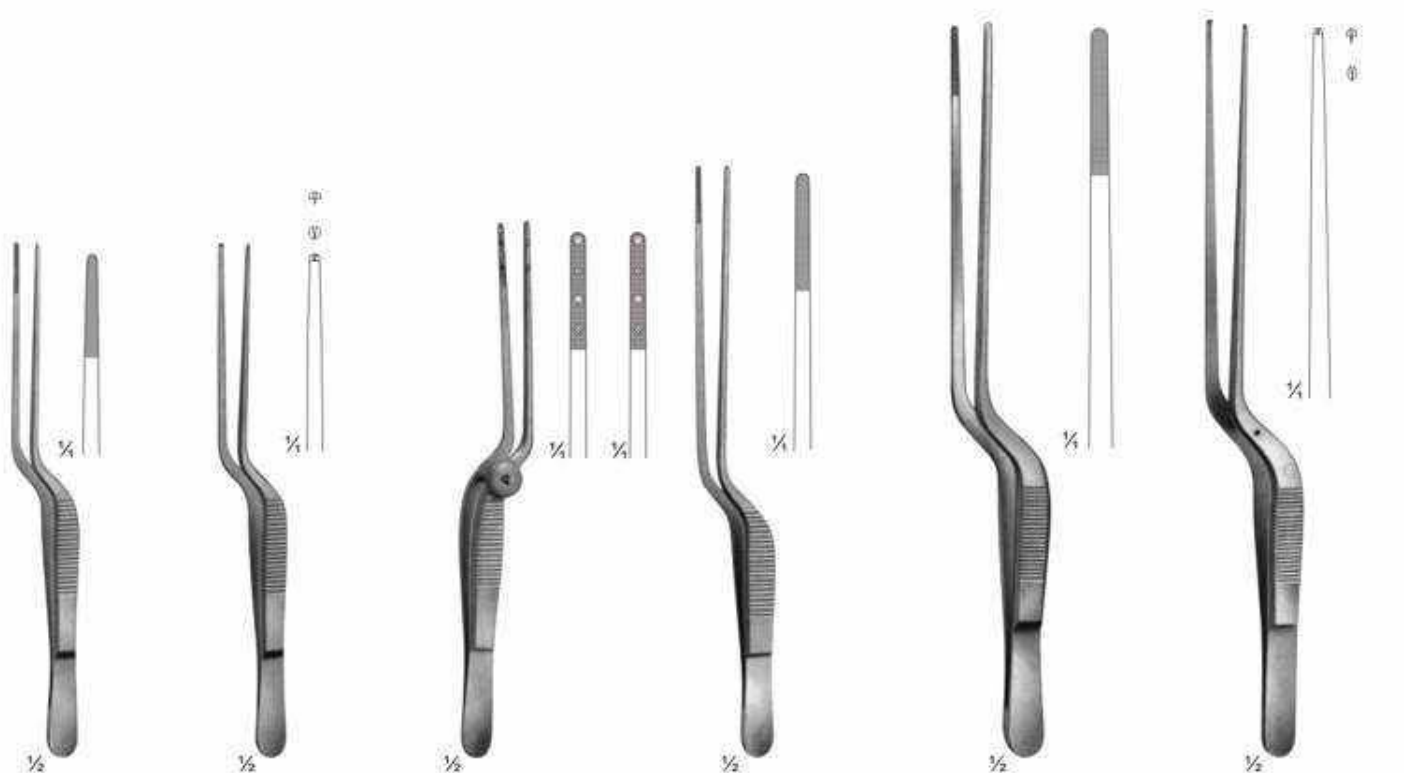

02-3409
LUCAE
 140 mm
 14cm
 6 inch

02-3410
LUCAE
 1x2 teeth
 140 mm
 14cm
 6 inch

02-3411
COTTLE
 Forceps with
 jaws toothed
 and serrated
 140 mm
 14cm
 6 inch

02-3412
JANSEN
 160 mm
 16cm
 6 inch

02-3413
GRUENWALD
 200 mm
 200cm
 8 inch

02-3414
 1x2 teeth
 200 mm
 200cm
 8 inch

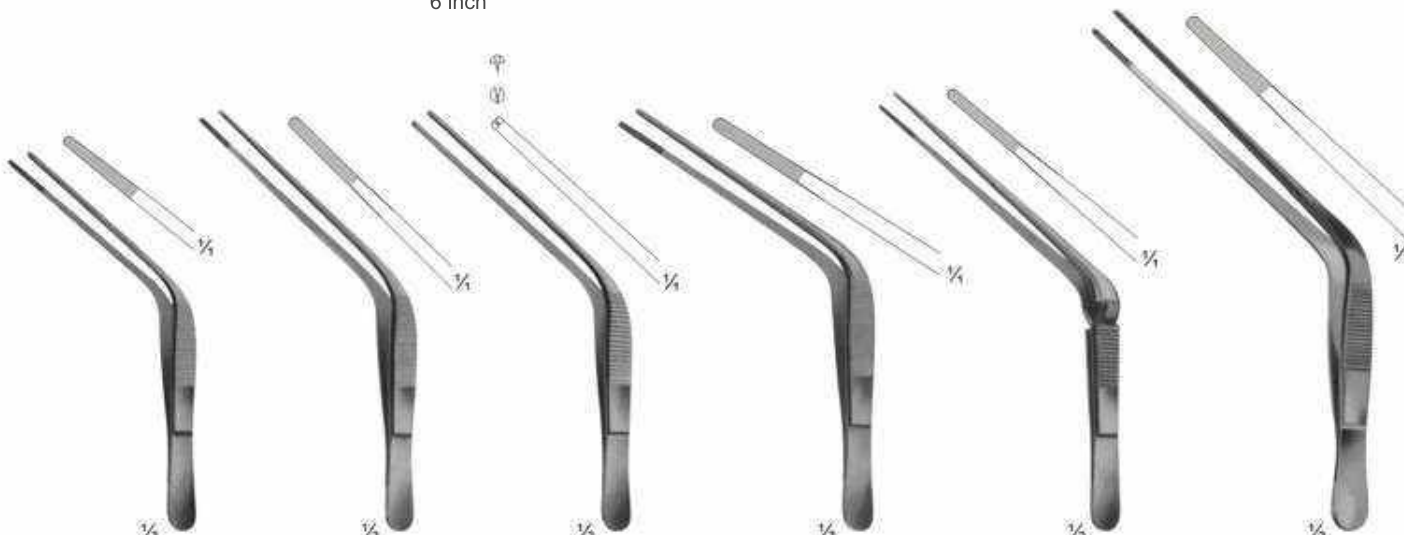

02-3415
TROELTSCH
 100 mm
 10cm
 4 inch

02-3416
TROELTSCH
 115 mm
 11.5cm
 5 inch

02-3417
TROELTSCH
 1X2 teeth
 115 mm
 11.5cm
 5 inch

02-3418
WILDE
 115 mm
 11.5cm
 5 inch

02-3419
TROELTSCH
 Cross action
 120 mm
 12cm
 5 inch

02-3420
TROELTSCH
 140 mm
 14cm
 6 inch

Delicate Tissue Forceps



02-3421
BISHOP-HARMON
 85 mm
 8.5cm
 3 inch

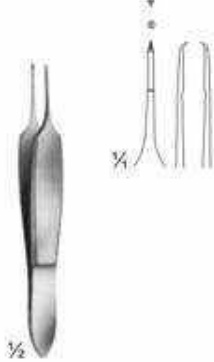

02-3422
ST.MARTIN
 80 mm
 8cm
 3 inch

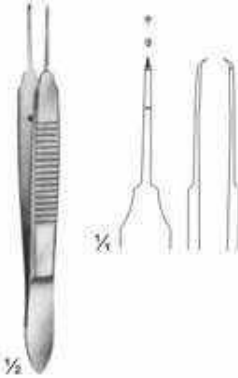

02-3423
CASTROVIEJO
 teeth 0.9 mm
 100 mm
 10cm
 4 inch

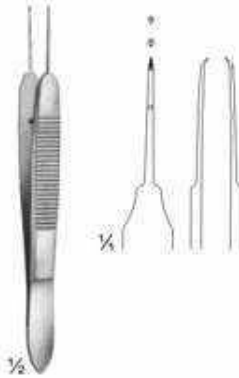

02-3424
CASTROVIEJO
 teeth 0.5 mm
 100 mm
 10cm
 4 inch



02-3425
ELSCHING
 110 mm
 11cm
 4 ipch



02-3426
GILL
 75 mm
 7.5cm
 3 inch



02-3427
GILL - HESS
 75 mm
 7.5cm
 3 inch

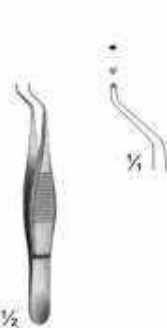

02-3428
HESS
 70 mm
 7cm
 3 inch



02-3429
ARRUGA
 100 mm
 10cm
 4 inch

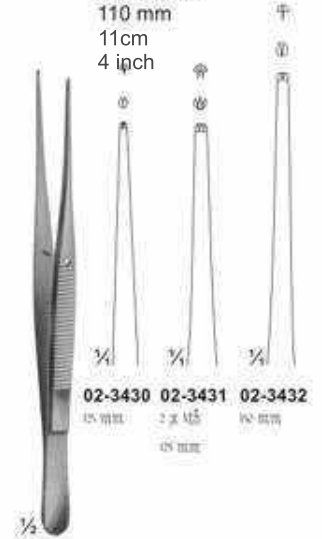

02-3430 - 02-3432
SEMKEN



02-3433
MICRO-ADSON
 120 mm
 12cm
 5 inch

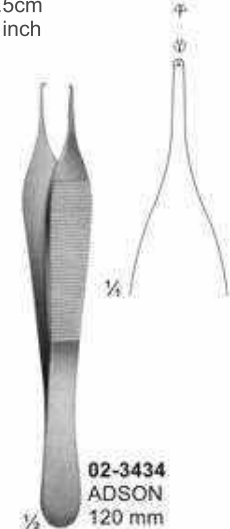

02-3434
ADSON
 120 mm
 12cm
 5 inch

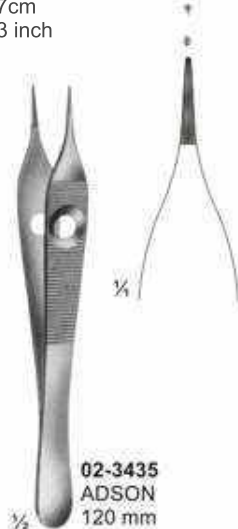

02-3435
ADSON
 120 mm
 12cm
 5 inch

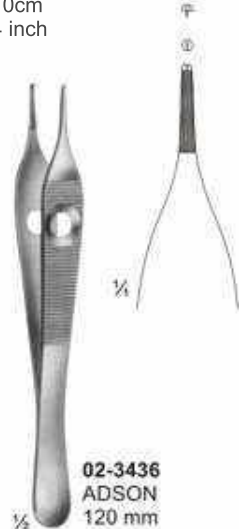

02-3436
ADSON
 120 mm
 12cm
 5 inch



02-3437
ADSON
 120 mm
 12cm
 5 inch

Tissue Forceps



02-3438
ADSON - BROWN
 Non-traumatic
 120 mm
 12cm
 5 inch

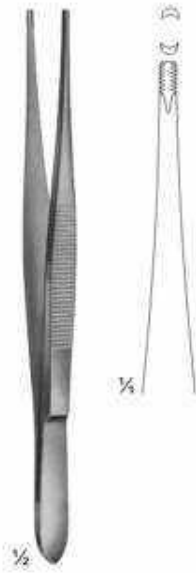

02-3439
BROWN
 150 mm
 15cm
 6 inch



02-3440
GRAEFE
 110 mm
 11cm
 4 inch

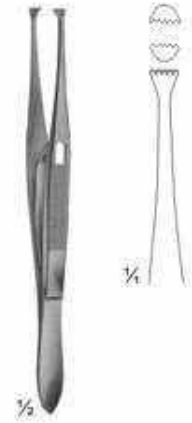

02-3441
GRAEFE
 With Catch
 110 mm
 11cm
 4 inch

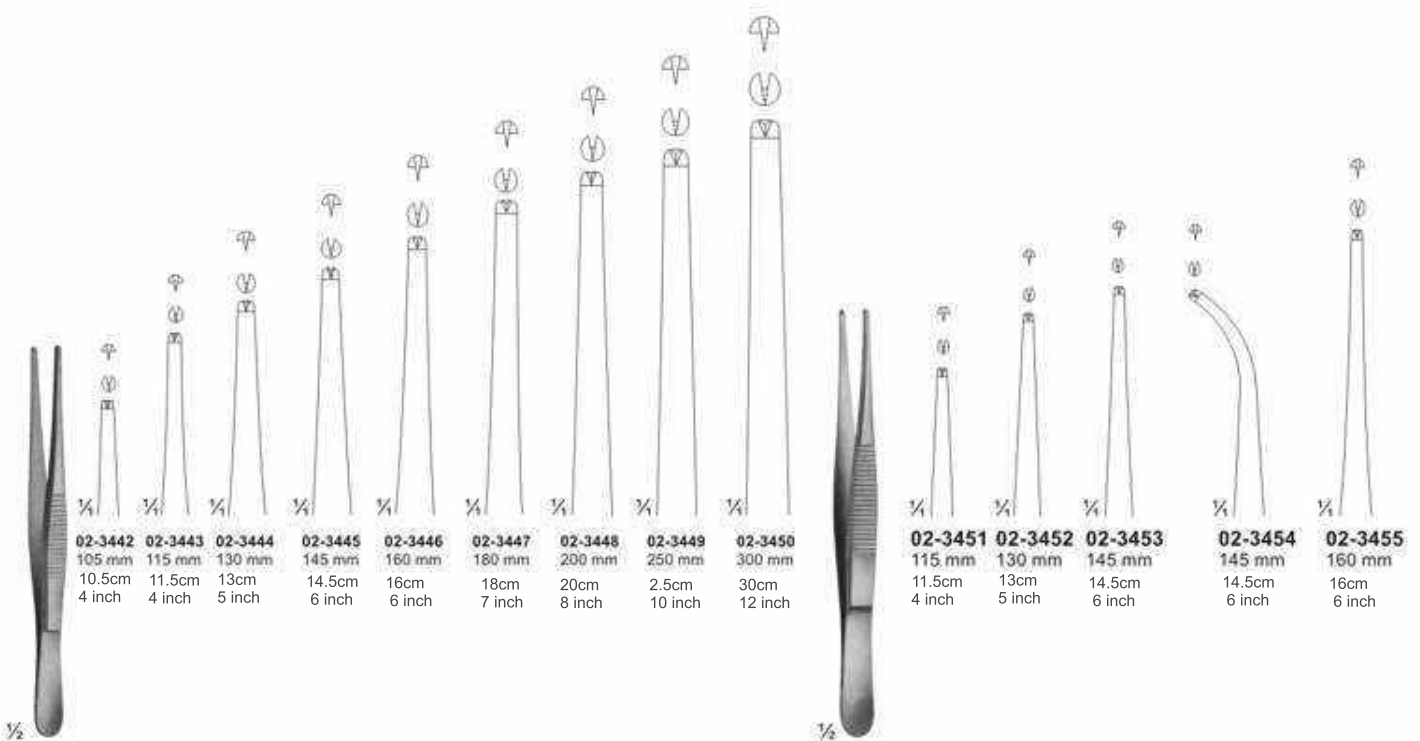

02-3442 - 02-3450
STANDARD

02-3451 - 02-3455
Medium

Tissue Forceps

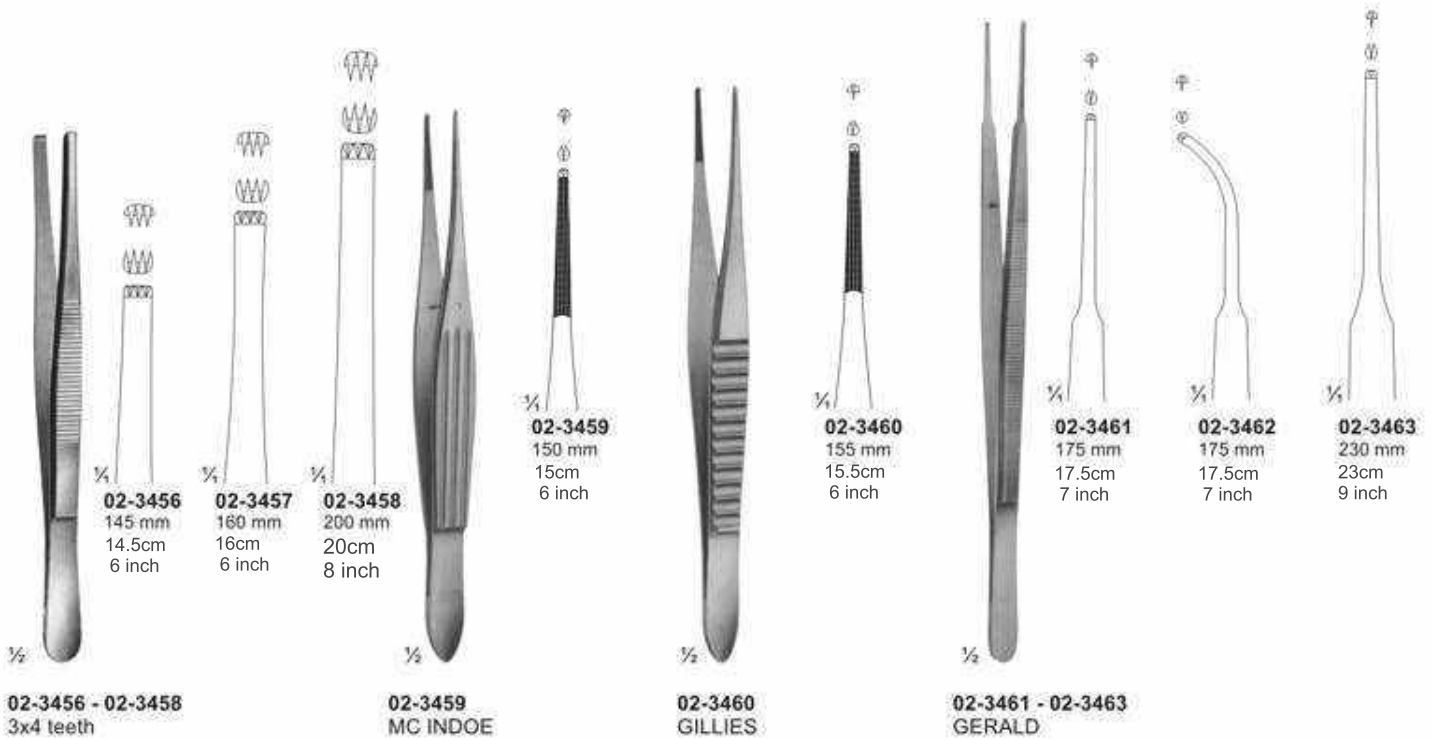

Tissue Forceps, Lung Dissecting Forceps,
Intestinal Forceps

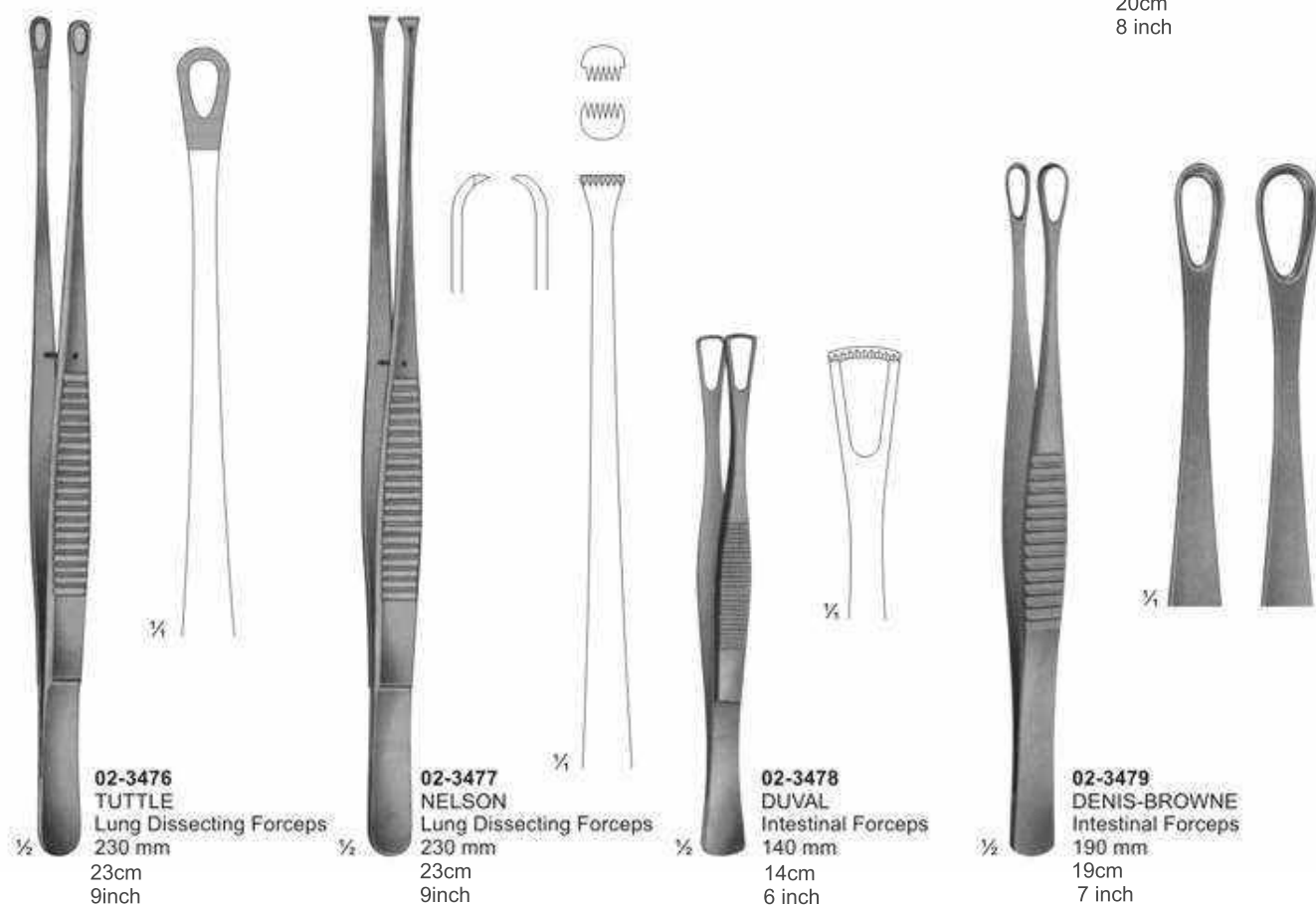
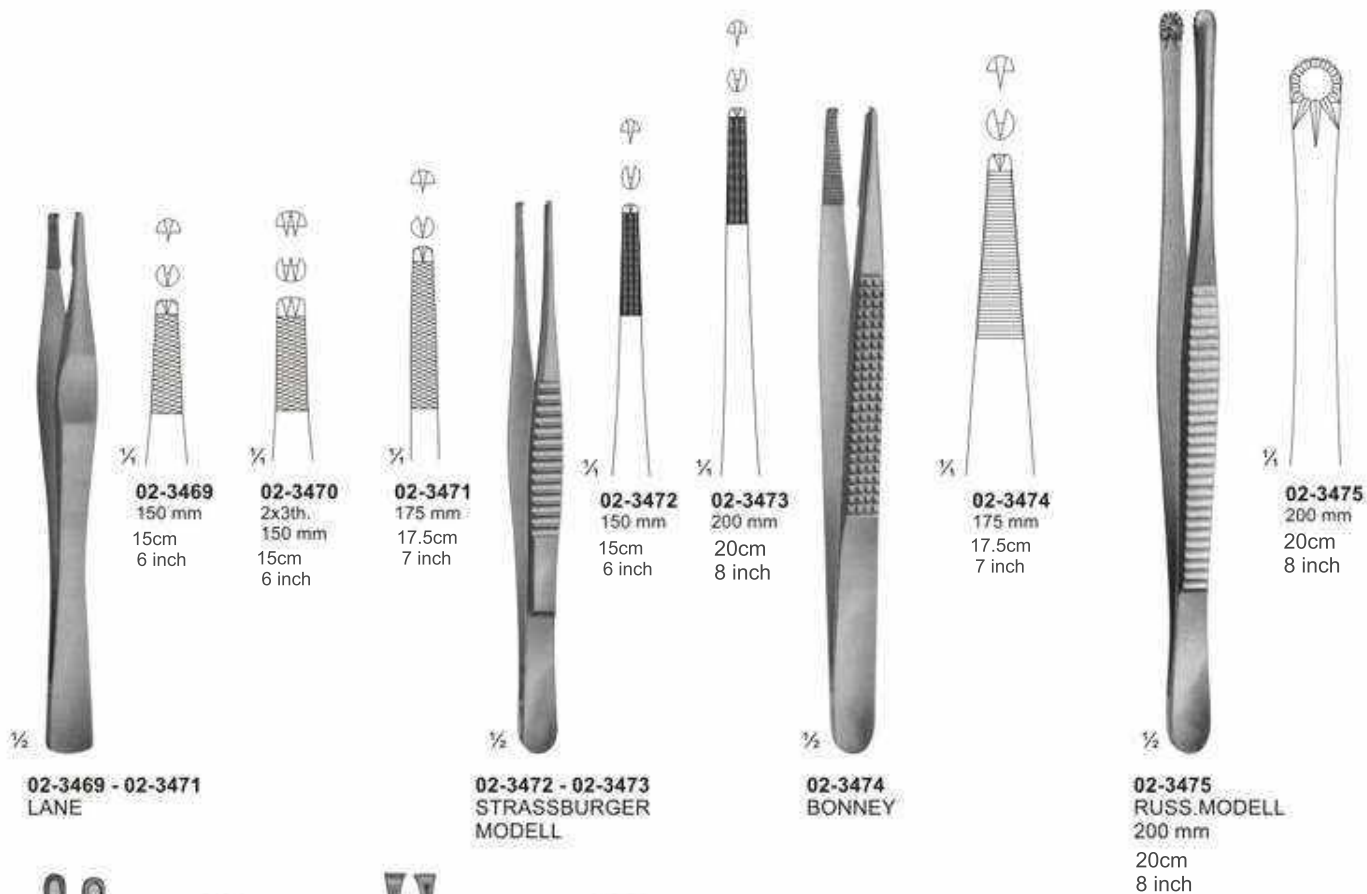



Splinter and Cilia Forceps

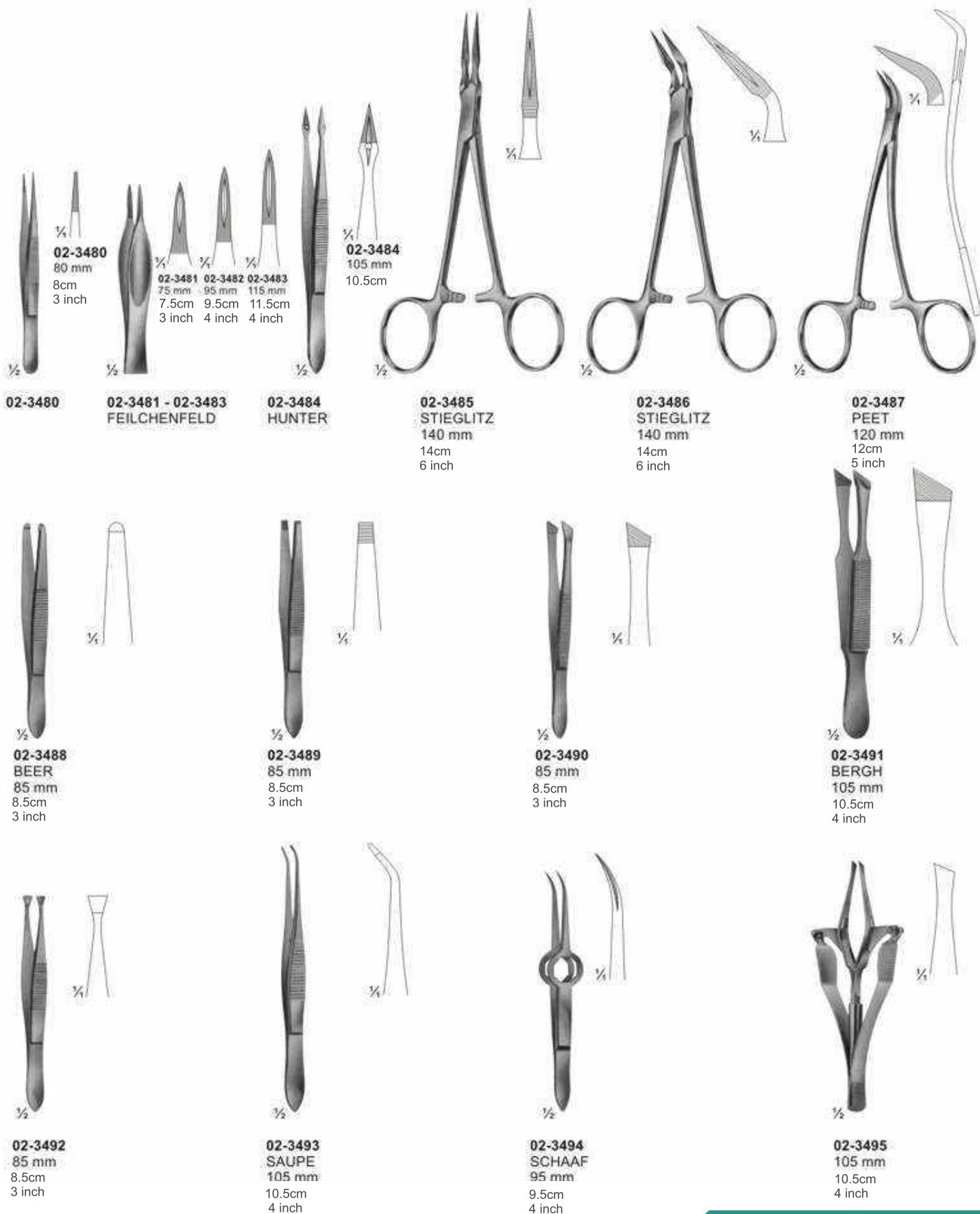

Sponge and Dressing Forceps



02-3496
BRYANT
 130 mm
 13cm
 5 inch

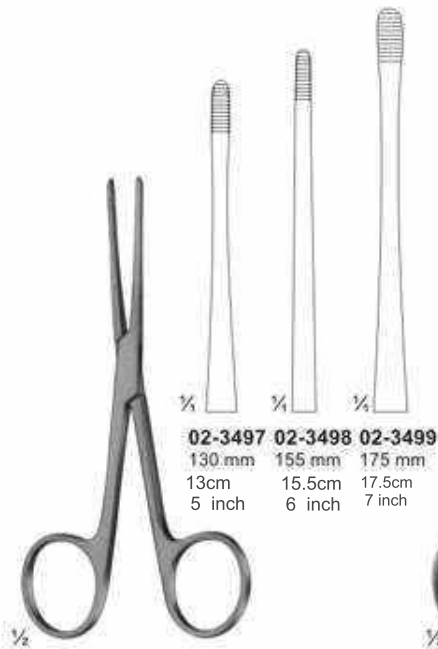

02-3497 - 02-3499
LISTER
 Sinus Forceps

02-3497 130 mm
 13cm
 5 inch
02-3498 155 mm
 15.5cm
 6 inch
02-3499 175 mm
 17.5cm
 7 inch

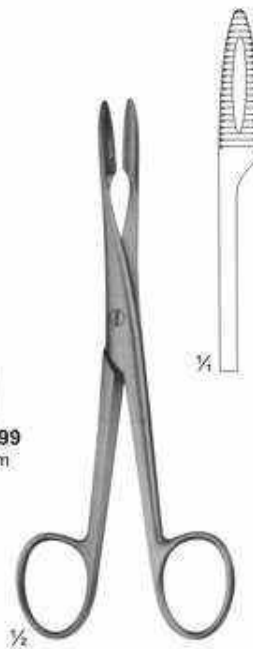

02-3500
 Without Ratchet
 145 mm
 14.5cm
 6inch

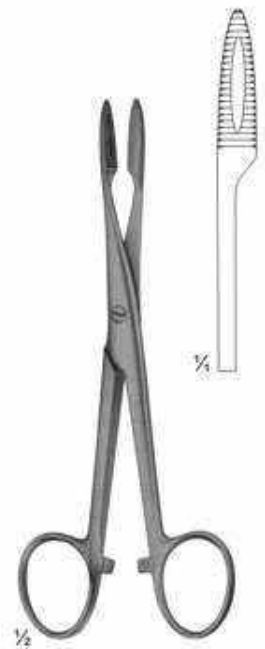

02-3501
 With Ratchet
 145 mm / 14.5cm / 6inch

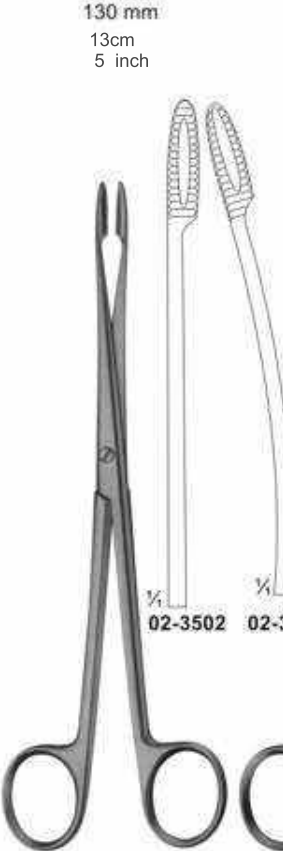

02-3502 - 02-3503
GROSS
 Without Ratchet
 180 mm
 18cm
 7 inch

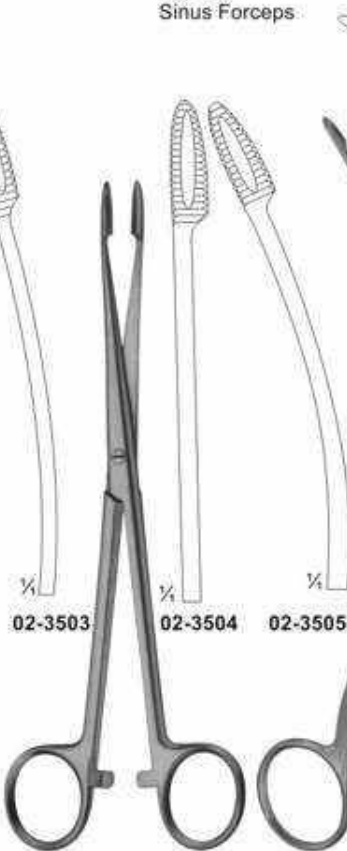

02-3504 - 02-3505
GROSS
 With Ratchet
 180 mm
 18cm
 7 inch



02-3506
DUPLAY
 190 mm
 19cm
 7 inch

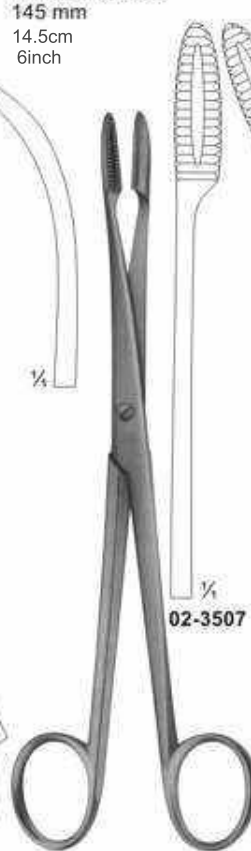

02-3507 - 02-3508
GROSS
 Without Ratchet
 200 mm
 20cm
 8 inch

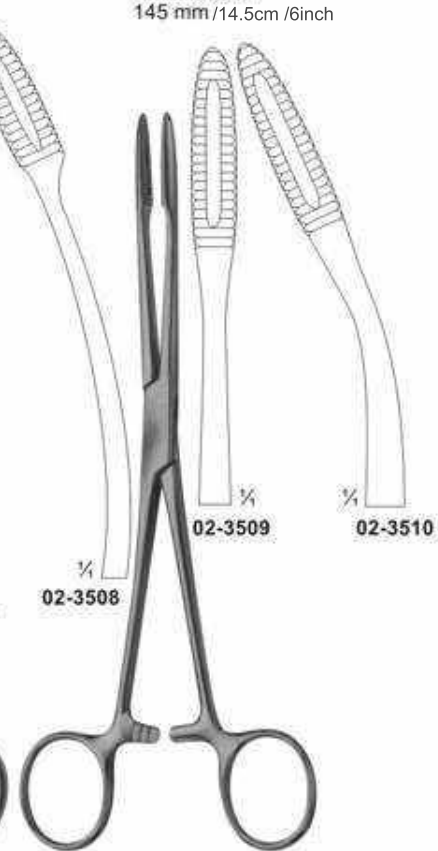

02-3509 - 02-3510
GROSS
 With Ratchet
 200 mm
 20cm
 8 inch

Sponge and Dressing Forceps



02-3511 - 03-3512
 ALM
 220 mm
 22cm
 9 inch

02-3513 - 02-3514
 MAIER
 Without Ratchet
 265 mm
 26.5cm
 10 inch

02-3515 - 02-3516
 MAIER
 With Ratchet
 265 mm
 26.5cm
 10 inch

Sponge and Dressing Forceps



02-3517

02-3518

02-3517 - 02-3518
SIMS-MAIER
 280 mm
 28cm
 11 inch

02-3519
COLLIN
 240 mm
 24cm
 9 inch

02-3520
CHERON
 Handles Laterally Angled
 240 mm
 24cm
 9 inch

02-3521
EMMET
 210 mm
 21cm
 8 inch

Dressing, Sponge Holding, Organ and Tissue Grasping Forceps and Haemostatic Forceps



02-3522



02-3523

02-3522 - 02-3523
FOERSTER-BALLENGER
180 mm
18cm
7 inch



02-3524 - 02-3525
RAMPLEY



02-3524
180 mm
18cm
7 inch



02-3525
250 mm
25cm
10 inch



02-3526 - 02-3529
FOERSTER-BALLENGER
240 mm
24cm
9 inch



02-3526
Smooth Jaws



02-3527
Smooth Jaws



02-3528
Serrated Jaws

02-3529
Serrated Jaws



02-3530
PENNINGTON
155 mm
15.5cm
6 inch



**Dressing, Sponge holding, Organ and
 Tissue Grasping Forceps**

ATRAUMATA



02-3531 - 02-3532
COLLIN



02-3531
 195 mm
 19.5cm
 8 inch



02-3532
 230 mm
 23cm
 9 inch

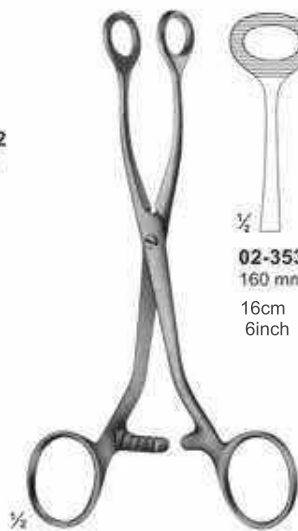

02-3533 - 02-3535
COLLIN



02-3533
 160 mm
 16cm
 6inch



02-3534
 160 mm
 16cm
 6inch



02-3535
 170 mm
 17cm
 6inch



02-3536
HEYWOOD-SMITH
 200 mm 20cm /8inch



02-3537
NOTO
 280 mm
 28cm
 11 inch



02-3538
KELLY
 320 mm
 32cm
 12 inch



Tendon Seizing Forceps



02-3539

02-3540

½
02-3539 - 02-3540
HERZ
155 mm
15.5cm
6 inch



02-3541

½
02-3541
JACKSON
4 x 5 teeth
150 mm
15cm
6 inch



½
02-3542
Tendon interlacing
forceps
150 mm / 15cm / 6 inch



½
02-3543
Tendon interlacing
forceps
150 mm / 15cm / 6 inch



½
02-3544
Tendon seizing
forceps
120 mm / 12cm / 5 inch

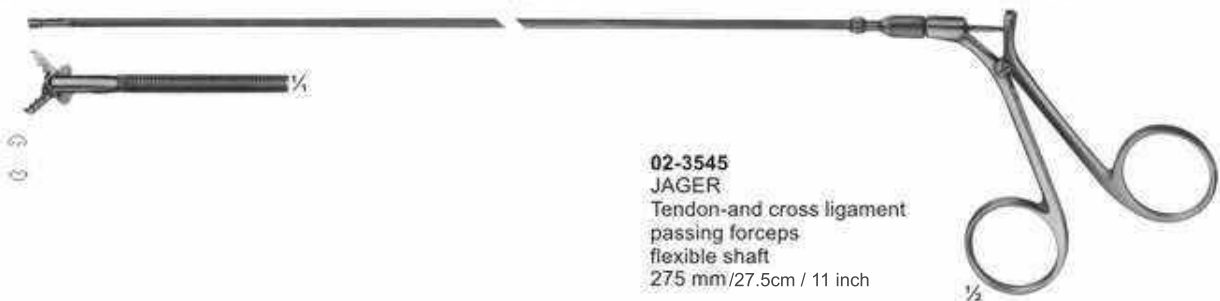

½
02-3545
JAGER
Tendon-and cross ligament
passing forceps
flexible shaft
275 mm / 27.5cm / 11 inch

Artery Traction - and Tissue Grasping Forceps

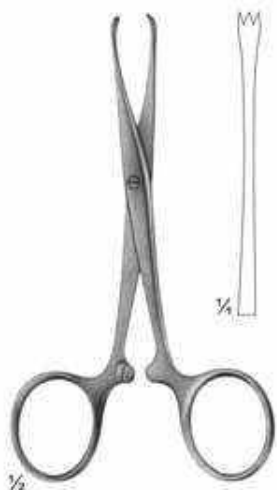

02-3546
CHAPUT
 2 x 3 teeth sharp
 125 mm
 12.5cm
 5 inch



02-3547
BABY-ALLIS
 4 x 5 teeth
 130 mm
 13 cm
 5 inch



02-3548
BOYS-ALLIS
 5 x 6 teeth sharp
 155 mm
 15.5cm
 6 inch

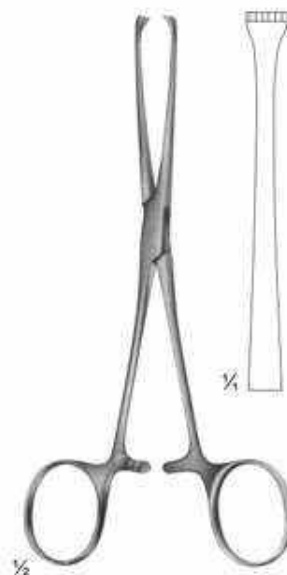

02-3549
ALLIS
 5 x 6 teeth blunt
 155 mm
 15.5cm
 6 inch



02-3550
LAHEY
 155 mm
 15.5cm
 6 inch

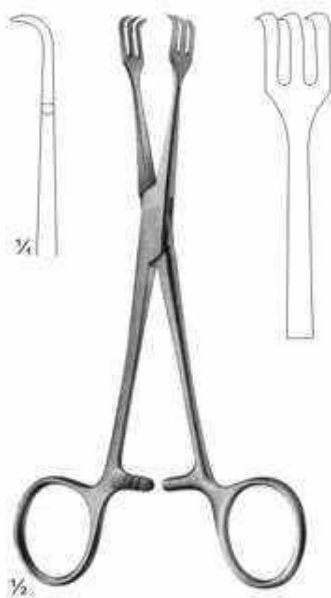

02-3551
LAHEY
 155 mm
 15.5cm
 6 inch

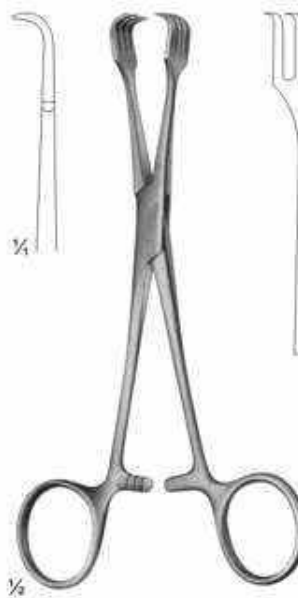

02-3552
BRAUN
 155 mm
 15.5cm
 6 inch

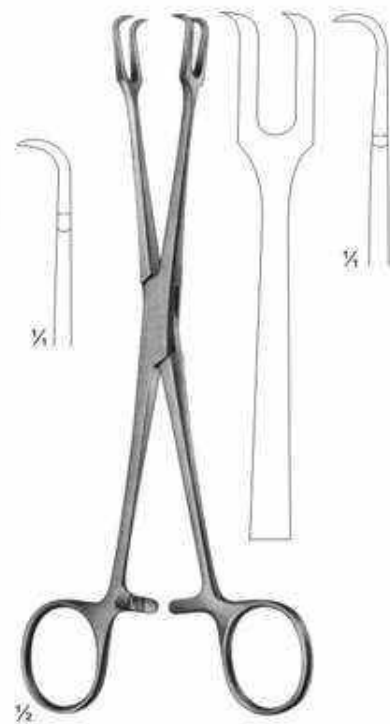

02-3553
MUSEUX
 200 mm /20cm /8inch

Organ - and Tissue Grasping Forceps

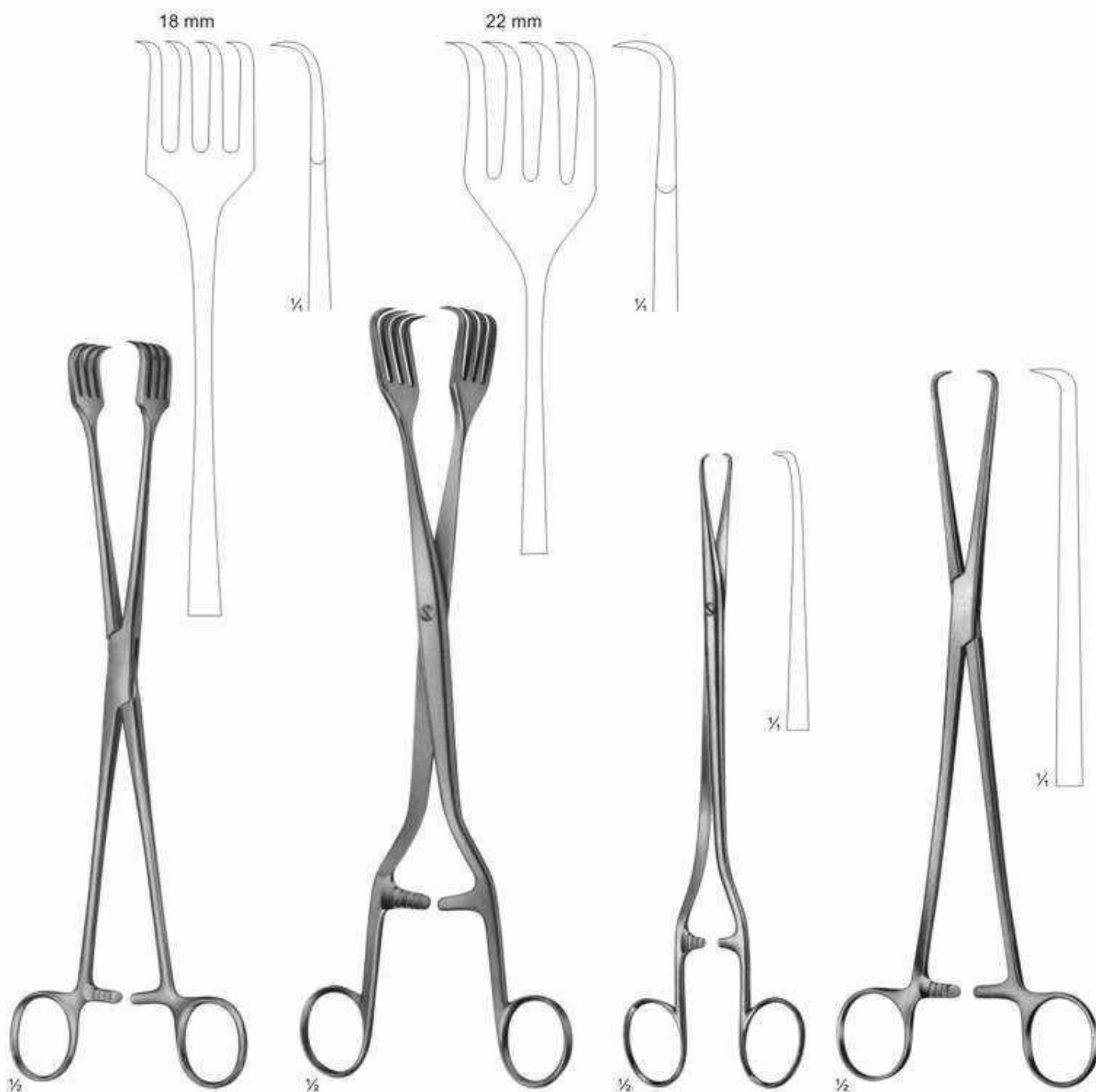

02-3554
ALM
 260 mm
 26 cm
 10 inch

02-3555
PRATT
 270 mm
 27 cm
 11 inch

02-3556
TIEMANN
 Bullet forceps
 220 mm
 22 cm
 9 inch

02-3557
SCHROEDER
 250 mm
 25 cm
 10 inch

Towel Clamps



02-3558
JONES
 85 mm
 8.5cm
 3 inch



02-3559
ENGL.MOD.
 85 mm
 8.5cm
 3 inch

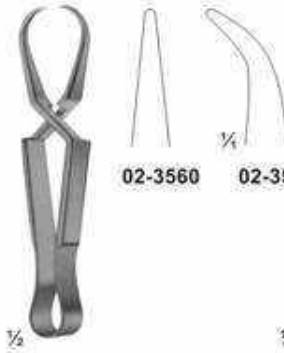

02-3560 - 02-3561
SCHAEFFEL
 85 mm
 8.5cm
 3 inch



02-3562
DOYEN
 110 mm
 11cm
 4 inch



02-3563
DOYEN
 180 mm
 18cm
 7 inch



02-3564
 130 mm
 13cm



02-3565
 155 mm
 15.5cm



02-3566
 195 mm
 19.5cm



02-3567
 80 mm
 8cm



02-3568
 105 mm
 10.5cm



02-3569
 90 mm
 9cm
 3 inch



02-3570
 110 mm
 11cm
 4 inch

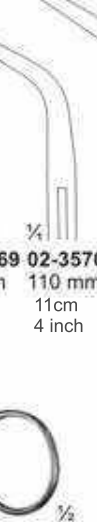

02-3571
 135 mm
 13.5cm
 5 inch

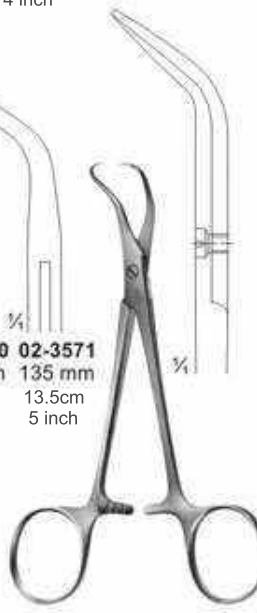

02-3572
BACKHAUS-KOCHER
 135 mm

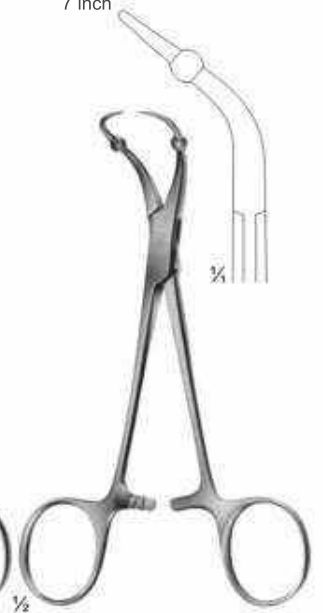

02-3573
ROEDER
 160 mm /16cm /6 inch

Towel Clamps and Safety Pins.



02-3574
ROBIN
with holders for tubing
up to 13 mm
135 mm
13.5cm
5 inch



02-3575
with clip for tubing
up to 15 mm
110 mm
11cm
4 inch



02-3576
LORNA
non perforating
130 mm
13cm
5 inch



02-3577
for paper cloths
140 mm
14cm
6 inch



02-3578
BUNT
105 mm
10.5cm
4 inch



02-3579
MAYO
140 mm
14cm
6 inch

Muller Vessel Clips and Bulldog Clamps

Closing force



02-3580
Straight
50g



02-3581
80g



02-3582
Curved
50g



02-3583
80g



02-3584
Curved tips
50g



02-3585
80g



02-3586
Angled
Shaped
50g



02-3587
80g



02-3588
Muller
Knee-bent
50g



02-3589
80g



02-3590
Muller
Ligature Forceps



Jaw, cross
serrated
Jaws profiles
finally cross-
serrated.

Non-traumatic vessel clips, temporary.



02-3591
38 mm
48 mm



02-3592
38 mm
48 mm



02-3593
58 mm



02-3594
58 mm



02-3595 - 02-3601

02-3595 38 mm /3.8cm
02-3596 48 mm /4.8cm
02-3597 56 mm /5.6cm
02-3598 63 mm /6.3cm
02-3599 70 mm /7cm
02-3600 80 mm /8cm
02-3601 91 mm /9.1cm /4 inch



02-3602
DE BAKEY-
HESS
Length of
Jaws 20 mm /2cm



Bulldog Clamps



02-3603
35 mm
3.5cm
1 inch



02-3604
35 mm
3.5cm
1 inch



02-3605
45 mm
4.5cm
2 inch



02-3606
45 mm
4.5cm
2 inch



DE BAKEY

02-3607
Length
50 mm
Jaws
27 mm



DE BAKEY

02-3608
Length
48 mm
Jaws
27 mm



75°

02-3609
GLOVER
Length
57 mm
Jaws 35 mm
3.5cm
1 inch



02-3610
DE BAKEY
Length 73 mm
Jaws 38 mm
3.8cm
1 inch

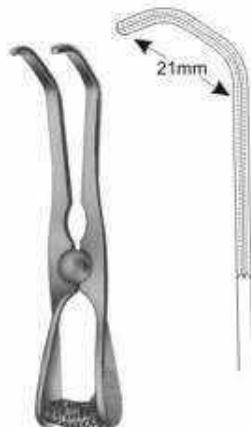

02-3611
DE BAKEY
Length 99 mm
Jaws 63 mm
6.3cm
2 inch



02-3612
DE BAKEY
Length 95 mm
Jaws 54 mm
5.4cm
2 inch



DE BAKEY

	Total length	Length of jaw
02-3613	80mm	25mm
02-3614	90mm	35mm
02-3615	105mm	50mm
02-3616	124mm	68mm



DE BAKEY

	Total length	Length of jaw
02-3617	78mm	25mm
02-3618	86mm	35mm
02-3619	97mm	50mm
02-3620	114mm	68mm



GLOVER

	Total length	Length of jaw
02-3621	68mm	33mm
02-3622	96mm	50mm
02-3623	117mm	69mm



GLOVER

	Total length	Length of jaw
02-3624	65mm	33mm
02-3625	91mm	50mm
02-3626	110mm	69mm

Delicate Haemostatic Forceps



02-3627
CARREL
85 mm
8.5cm
3 inch



02-3628 - 02-3631
BABY-MOSQUITO
(HARTMANN)
100 mm
10cm
4 inch



02-3632 - 02-3635
MICRO-HALSTED
125 mm
12.5cm
4 inch

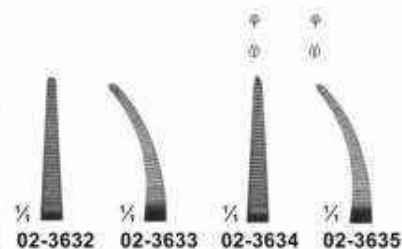
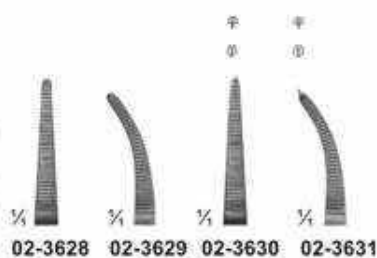

02-3636 - 02-3639
HALSTED-MOSQUITO
125 mm
12.5cm
4 inch



02-3640 - 02-3641
PROVIDENCE-HOSPITAL
140 mm
14cm
6 inch

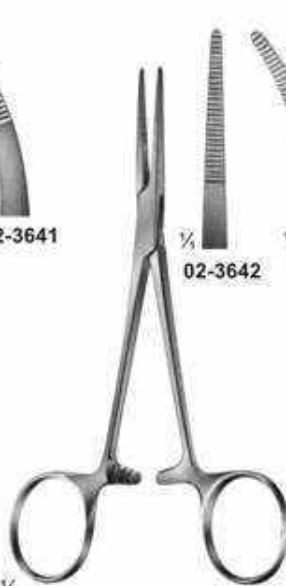

02-3642 - 02-3643
KELLY
140 mm
14cm
6 inch

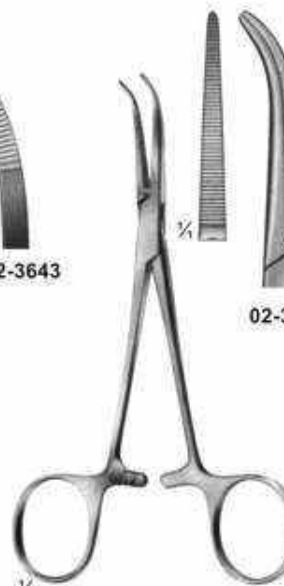

02-3644 - 02-3645
DANDY
Curved sideways
140 mm
14cm
6 inch

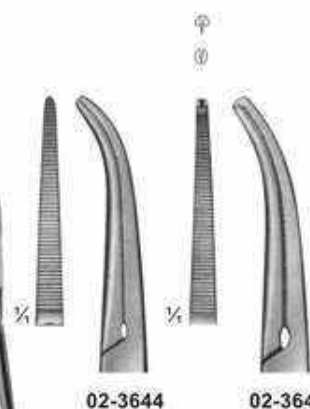
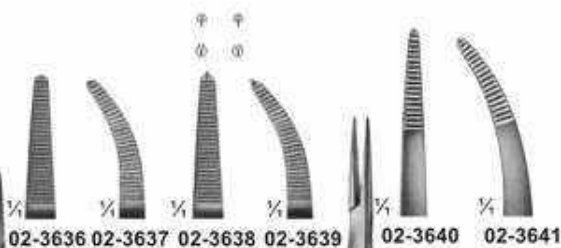

Delicate Haemostatic Forceps

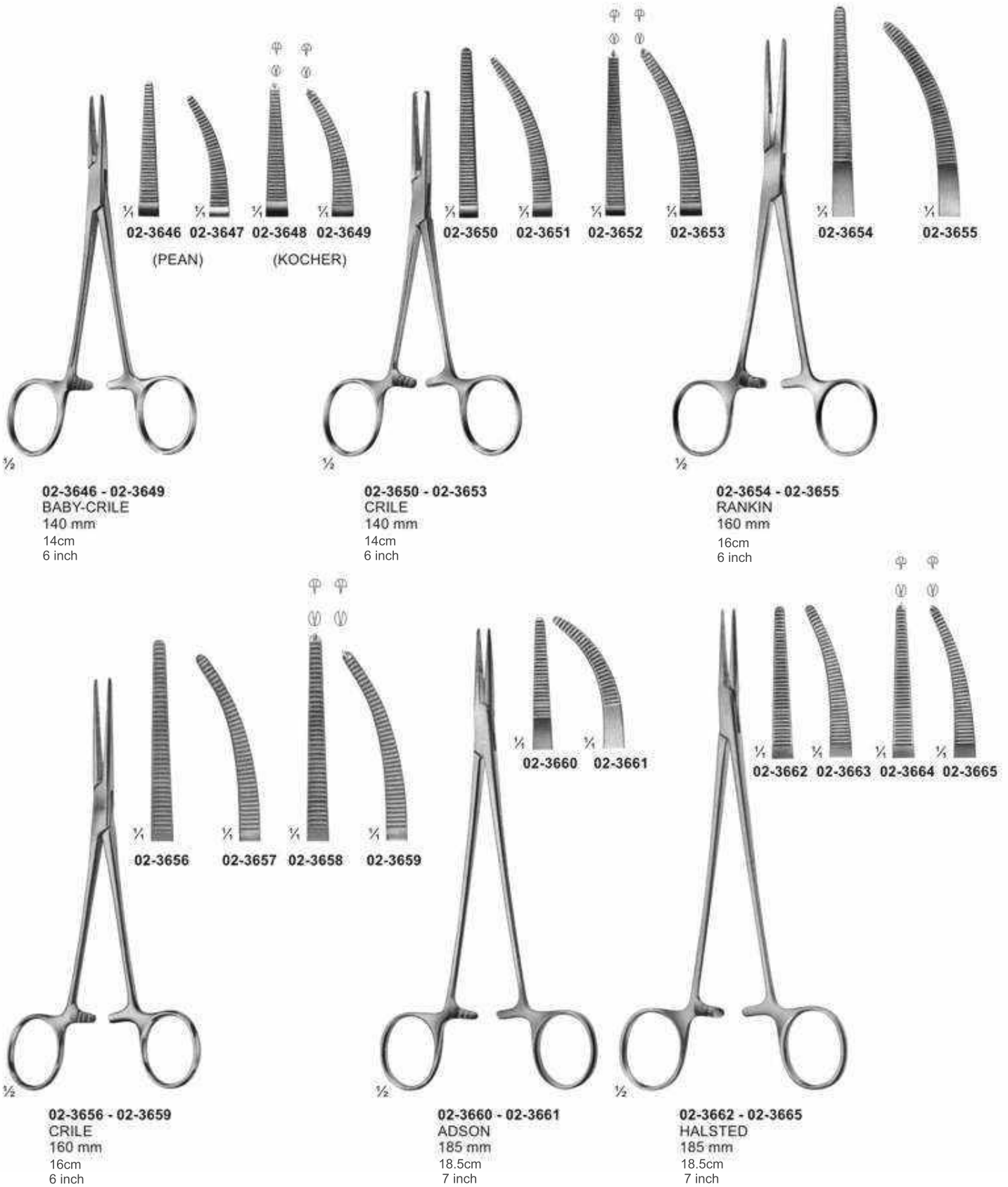

Delicate Haemostatic Forceps

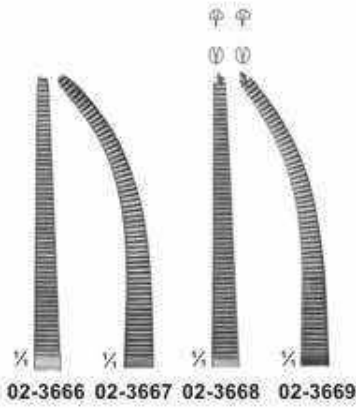

1/2
02-3666 - 02-3669
HALSTED-MOSQUITO
200 mm
20cm
8 inch

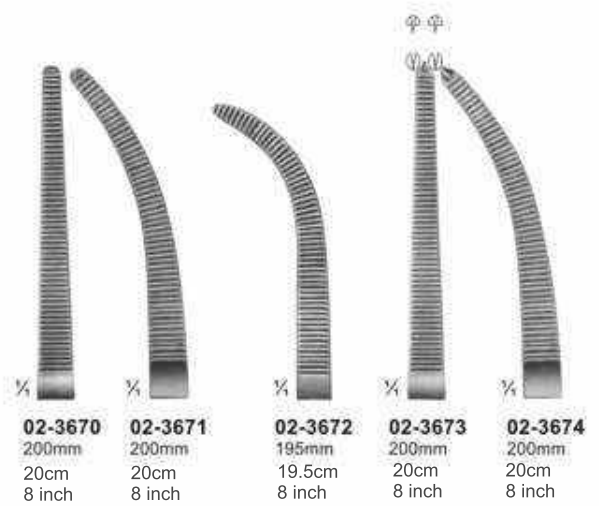

02-3670 - 02-3674
HEISS



02-3675 - 02-3676
HALSTED
215 mm / 21.5cm / 8 inch

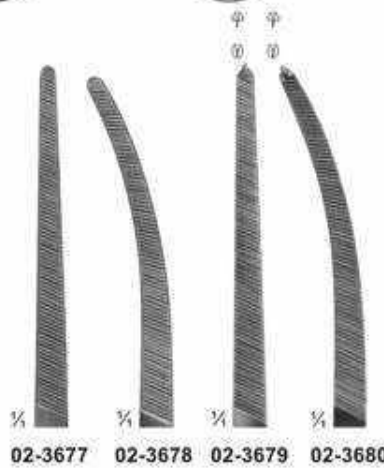
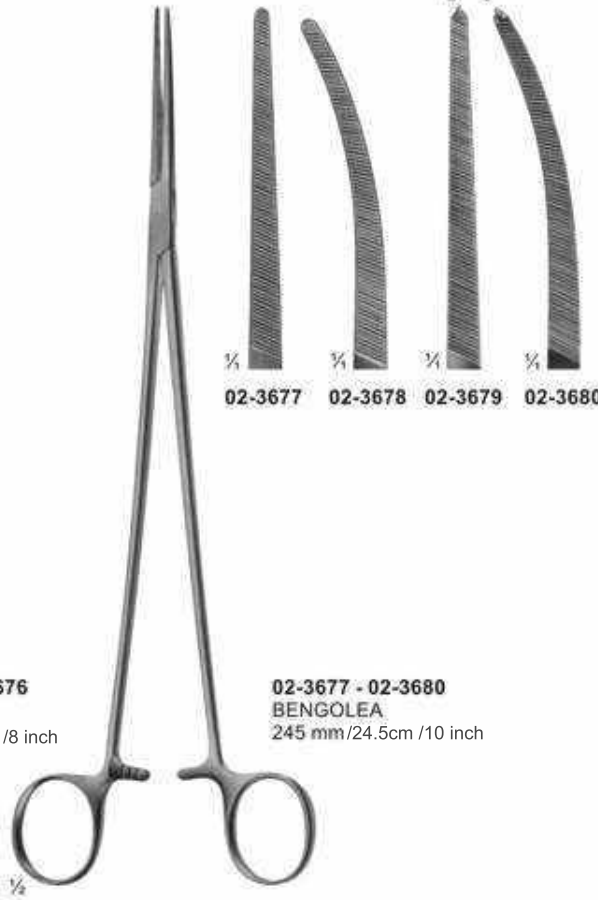

02-3677 - 02-3680
BENGOLEA
245 mm / 24.5cm / 10 inch

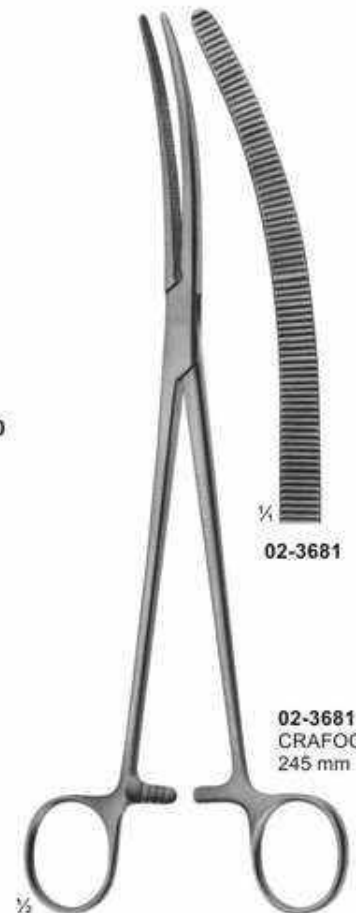

02-3681
CRAFOORD
245 mm / 24.5cm
10 inch

Haemostatic Forceps

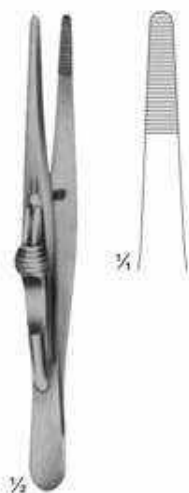

02-3682
FRICKE
Artery forceps
130 mm
13cm
5 inch



02-3683
KRONLEIN
130 mm
13cm
5 inch



02-3684
PEAN
125 mm
13cm
5 inch



02-3685
125 mm
12.5cm
5 inch



02-3686
140 mm
14cm
6 inch



02-3687
PEAN
125mm

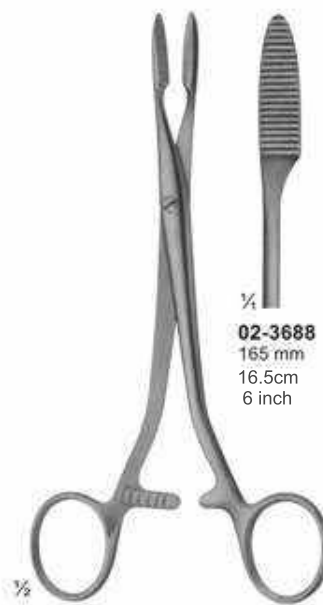

02-3688
165 mm
16.5cm
6 inch



02-3689
185 mm
18.5cm
7 inch

02-3688 - 02-3689
PEAN

Haemostatic Forceps



02-3690 - 02-3693
PEAN
Slender type

02-3694 - 02-3702
SPENCER-WELLS

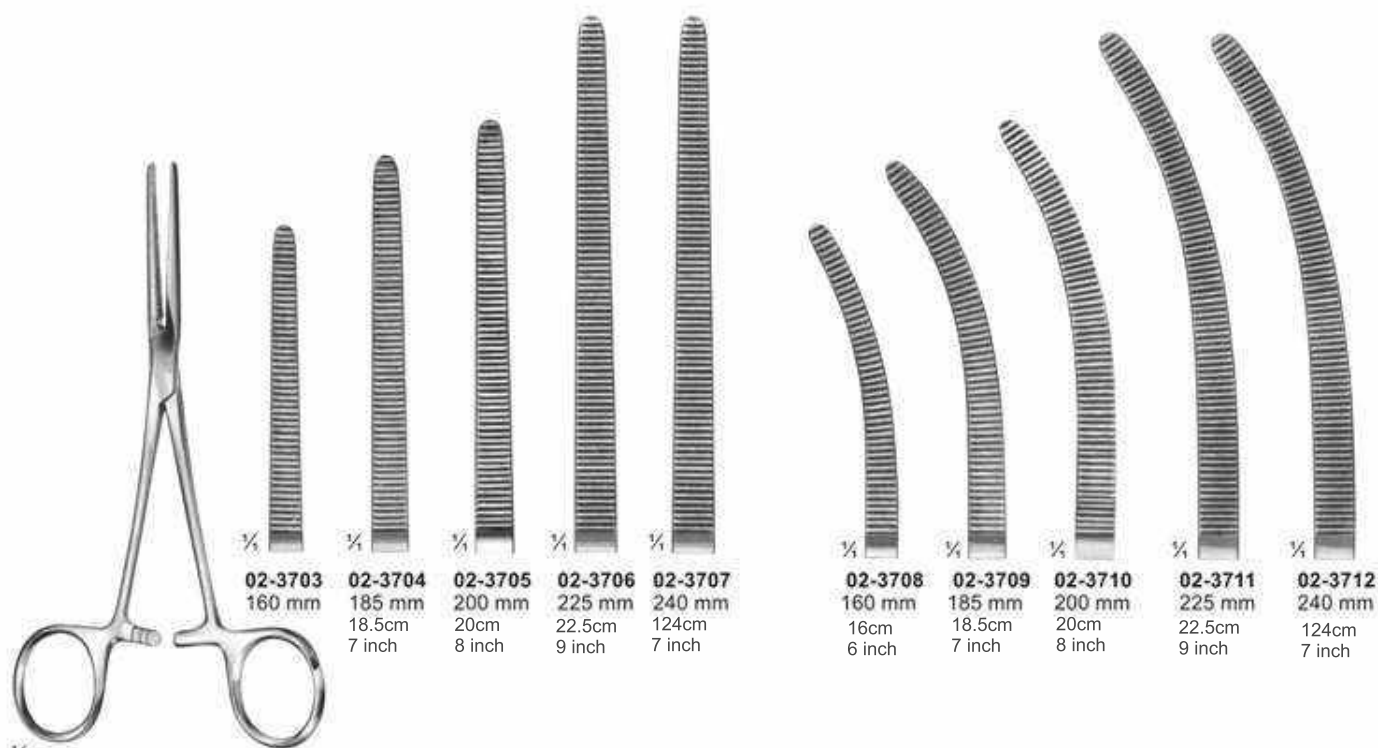

02-3703 - 02-3712
ROCHESTER-PEAN

Haemostatic Forceps

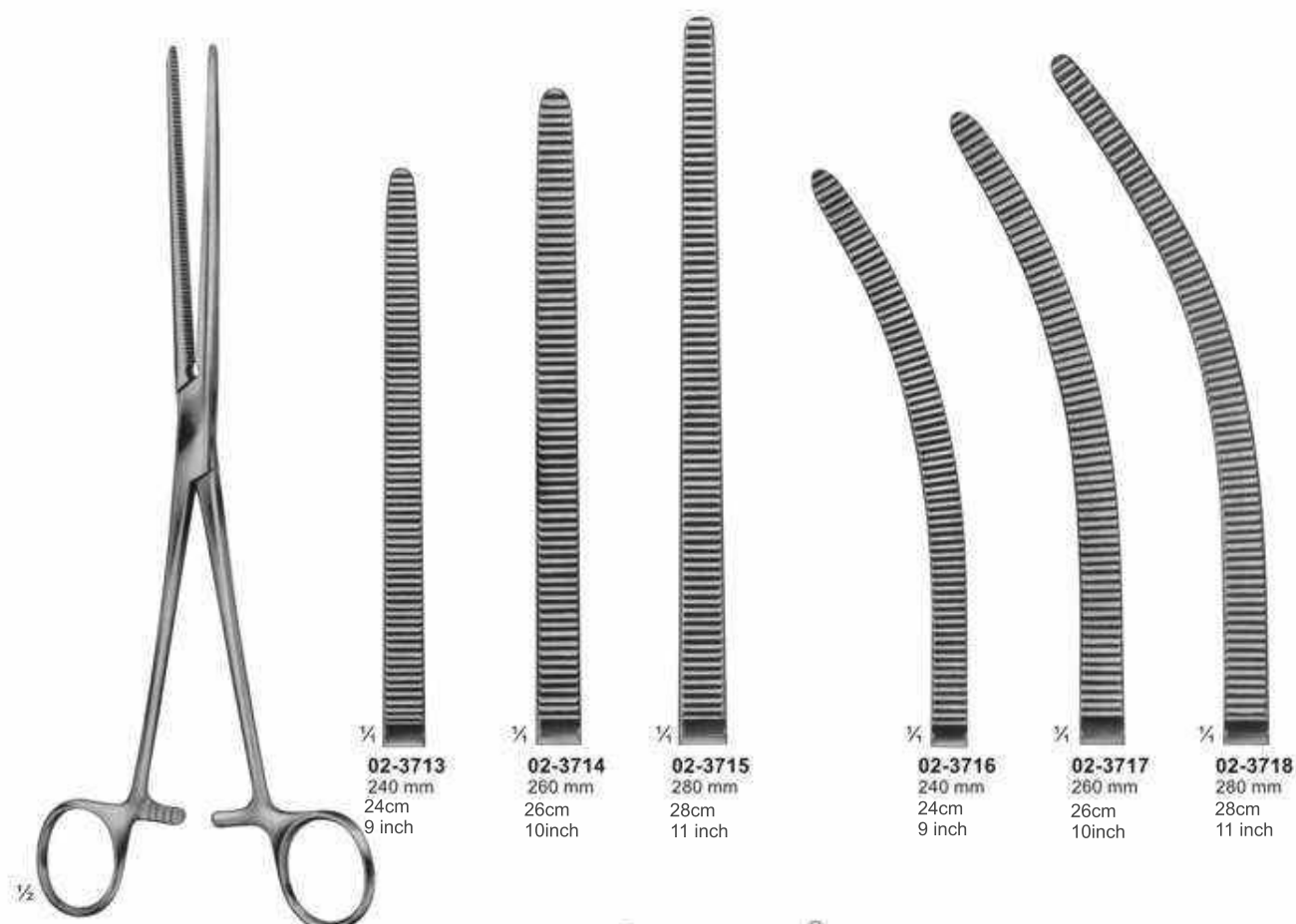

02-3713 - 02-3718
PEAN

02-3713
240 mm
24cm
9 inch

02-3714
260 mm
26cm
10inch

02-3715
280 mm
28cm
11 inch

02-3716
240 mm
24cm
9 inch

02-3717
260 mm
26cm
10inch

02-3718
280 mm
28cm
11 inch



02-3719
KOCHER
Strong Pattern
145 mm
14.5cm
6 inch

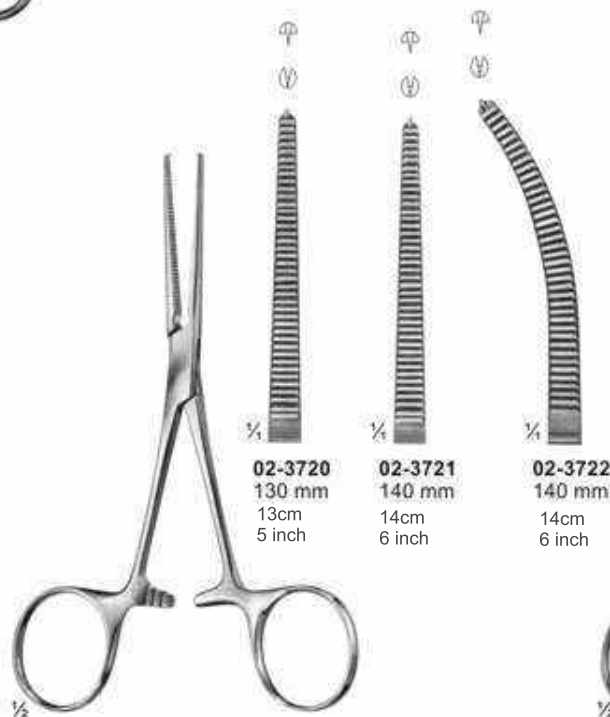

02-3720
130 mm
13cm
5 inch

02-3721
140 mm
14cm
6 inch

02-3722
140 mm
14cm
6 inch

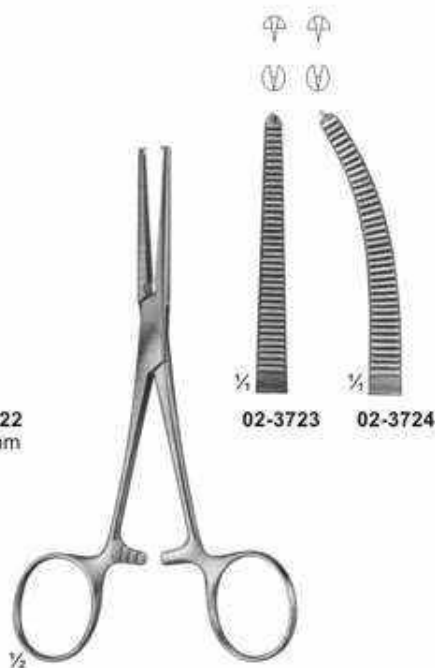

02-3723 - 02-3724
ROCHESTER-OCHSNER
140 mm
14cm
6 inch

Haemostatic Forceps

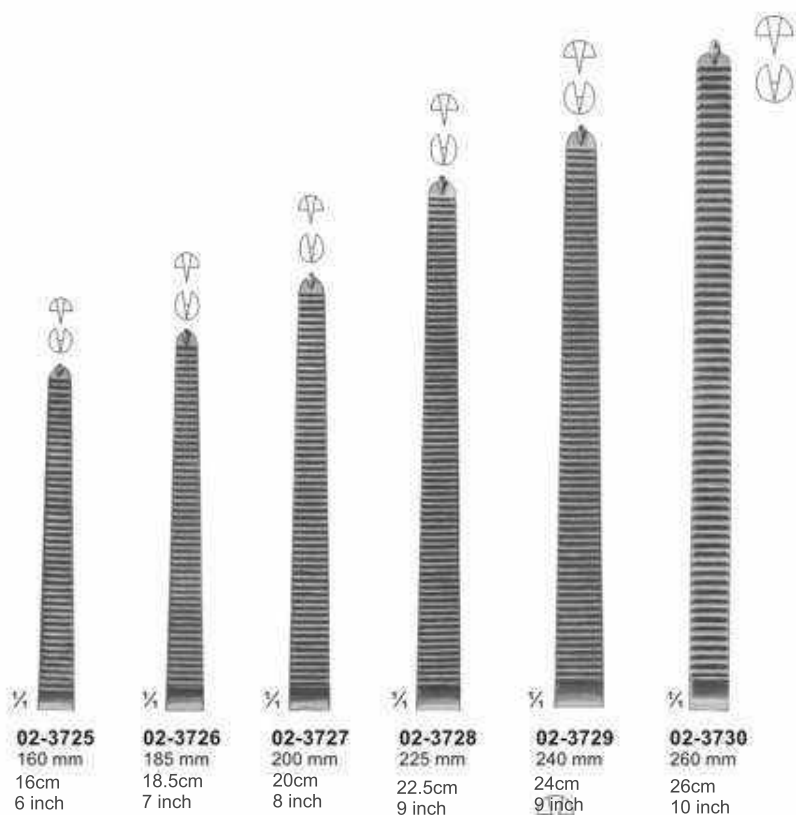

02-3725 - 02-3736
 KOCHER-OCHSNER

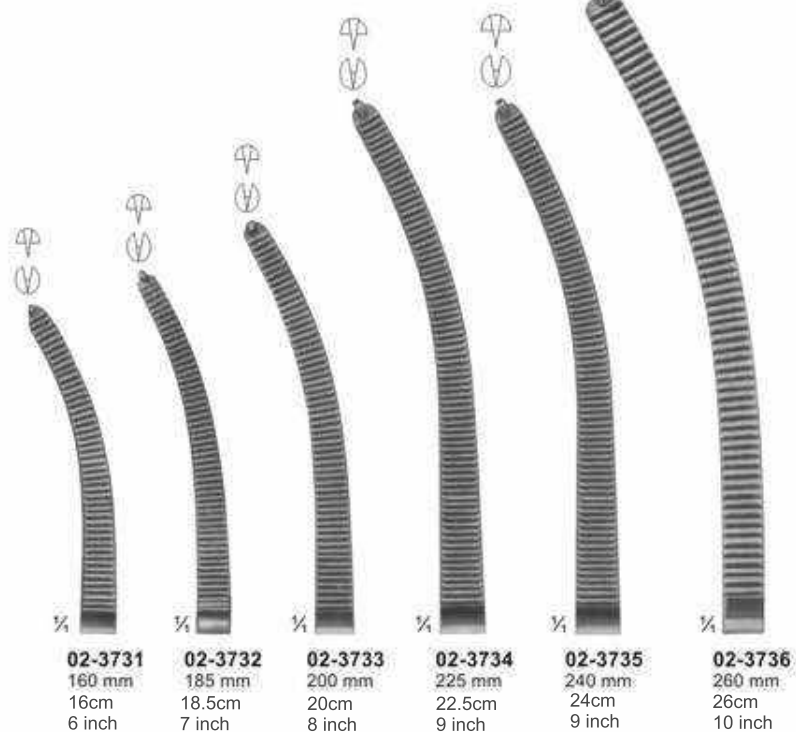

Haemostatic Forceps, Special Pattern, Tonsil Forceps



02-3737 160 mm
16cm
6 inch

02-3738 200 mm
20cm
8 inch

02-3739 160 mm
16cm
6 inch

02-3740 200 mm
20cm
8 inch

02-3737 - 02-3740
ROCHESTER-CARMALT



02-3741 230 mm
23cm
9 inch

02-3742 240 mm
24cm
9 inch

02-3741 - 02-3742
MOYNIHAN

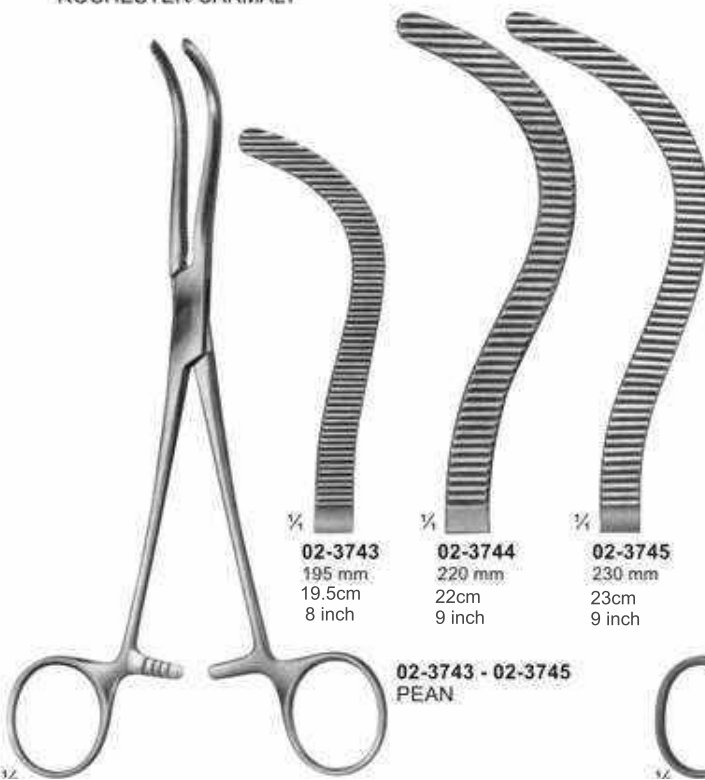

02-3743 195 mm
19.5cm
8 inch

02-3744 220 mm
22cm
9 inch

02-3745 230 mm
23cm
9 inch

02-3743 - 02-3745
PEAN



02-3746 **02-3747**

02-3746 - 02-3747
NEGUS
190 mm / 19cm / 7 inch

02-3748
MIKULICZ
185 mm
18.5cm
7 inch

Dissecting- and Ligature Forceps



02-3749
MICRO-ADSON
 140 mm
 14cm
 6 inch



02-3750
BABY-OVERHOLT
 135 mm
 13.5cm
 5 inch



02-3751 - 02-3752
BABY-MIXTER

02-3751
 140 mm

02-3752
 180 mm



02-3753 - 02-3754
BABY-ADSON

02-3753
 140 mm
 14cm
 6 inch

02-3754
 180 mm
 18cm
 7 inch



02-3755
NISSEN

02-3755
 185 mm
 18.5cm
 7 inch



02-3756 - 02-3757
YASARGIL
 195 mm
 19.5cm
 8 inch

02-3756

02-3757



02-3758
OVERHOLT-MIXTER

02-3758
 205 mm
 20.5cm
 8 inch

Dissecting- and Ligature Forceps

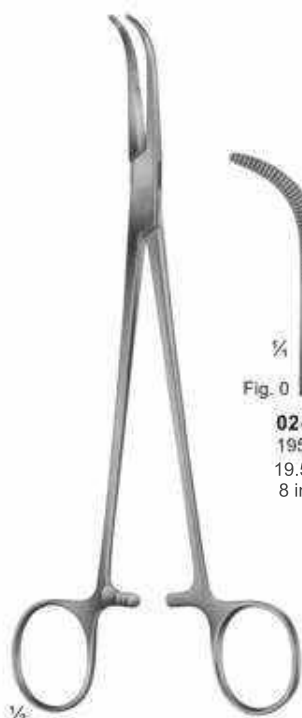

1/2

02-3759 - 02-3770
OVERHOLT-GEISSENDOERFER

Fig. 0	1	2	3	4	5	6
02-3759 195 mm 19.5cm 8 inch	02-3760 210 mm 21cm 02-3766 260 mm 26cm 10 inch	02-3761 220 mm 22cm 02-3767 270 mm 27cm 10inch	02-3762 225 mm 22.5cm 02-3768 275 mm 27.5cm 11 inch	02-3763 210 mm 21cm 02-3769 270 mm 27cm 10inch	02-3764 230 mm 23cm 02-3770 280 mm 28cm 11 inch	02-3765 225 mm 22.5cm



1/2

02-3771 - 02-3778
OVERHOLT
fine pattern

Fig. 0	1	2	3	6	0	1	6
02-3771 215 mm 21.5cm 8 inch	02-3772 210 mm 21cm 8 inch	02-3773 220 mm 22cm 9 inch	02-3774 225 mm 22.5cm 9 inch	02-3775 225 mm 22.5cm 9 inch	02-3776 295 mm 29.5cm 12 inch	02-3777 295 mm 29.5cm 12 inch	02-3778 300 mm 30cm 12 inch

Dissecting- and Ligature Forceps



02-3779
MIXTER-O'SHAUGHNESSY
190 mm
19 cm
7 inch



02-3780
HEISS
195 mm
19.5 cm
8 inch



02-3781 - 02-3785
RUMEL
240 mm
24cm
9 inch

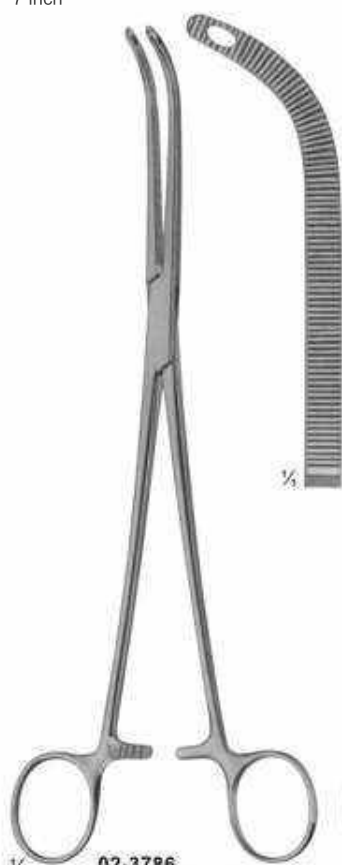
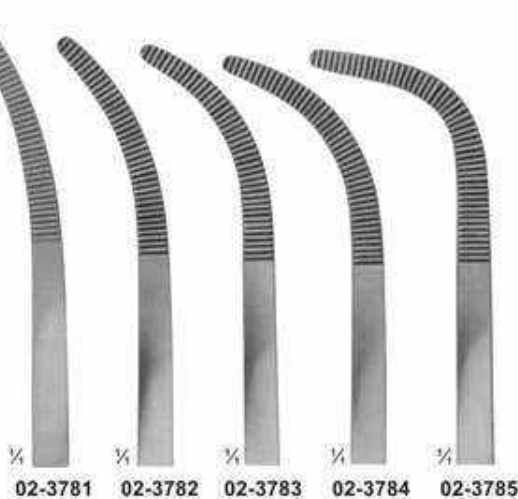

02-3786
FINOCHIETTO
245 mm



02-3787
MIXTER
220 mm



02-3788
LAWRENCE
220 mm

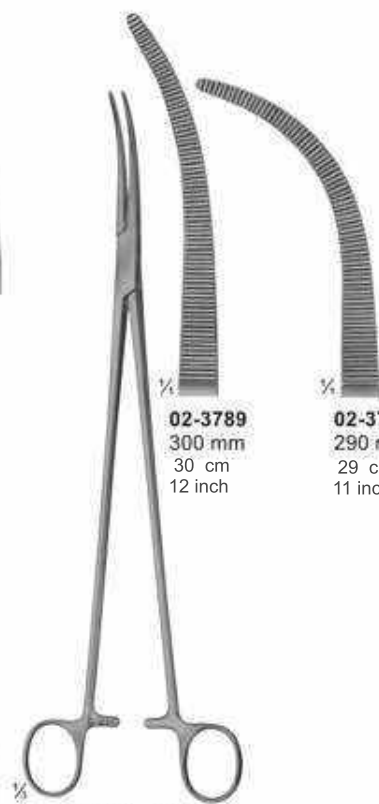

02-3789
300 mm
30 cm
12 inch

02-3790
290 mm
29 cm
11 inch

Dissecting- and Ligature Forceps



$\frac{1}{4}$
02-3791
180 mm
18cm
7 inch

$\frac{1}{2}$
02-3791
LOWER



$\frac{1}{4}$ $\frac{1}{4}$
02-3792 02-3793
190 mm 220 mm
19cm 22cm
7 inch 9 inch

$\frac{1}{2}$
02-3792 - 02-3793
LAHEY (SWEET)



$\frac{1}{4}$ $\frac{1}{4}$
02-3794 02-3795
220 mm 250 mm
22cm 25cm
9 inch 10 inch

$\frac{1}{2}$
02-3794 - 02-3795
MIXTER.



$\frac{1}{4}$
02-3796
220 mm
22cm
9 inch

$\frac{1}{2}$
02-3796
DESJARDINS

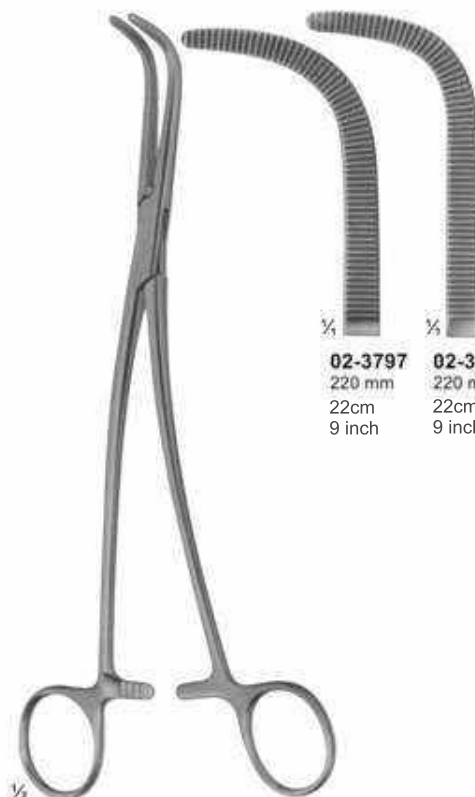

$\frac{1}{4}$ $\frac{1}{4}$
02-3797 02-3798
220 mm 220 mm
22cm 22cm
9 inch 9 inch

$\frac{1}{2}$
02-3797 - 02-3798
GRAY

Peritoneum Forceps



02-3799
BABY-MIKULICZ
 140 mm
 14cm
 6 inch



02-3800
MIKULICZ
 185 mm
 18.5cm
 7 inch

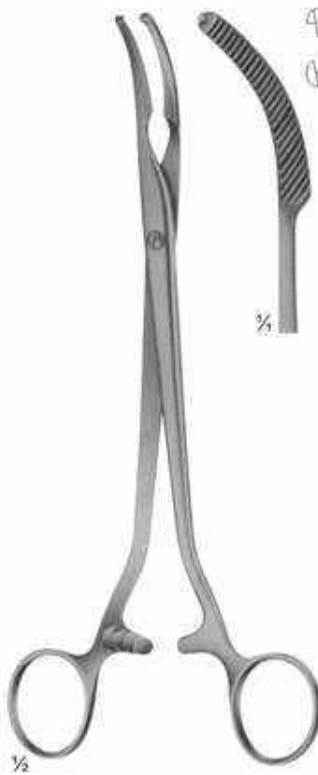

02-3801
MIKULICZ
 205 mm
 20.5cm
 8 inch

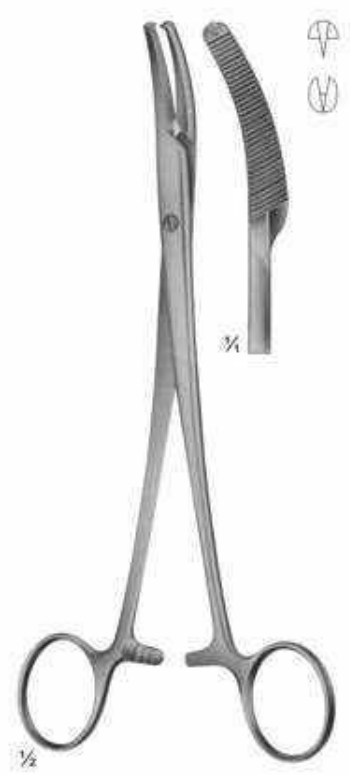

02-3802
MIKULICZ
 200 mm
 20cm
 8 inch



02-3803
MIKULICZ
 205 mm
 20.5cm
 8 inch



02-3804
MIKULICZ
 185 mm
 18.5cm
 7 inch

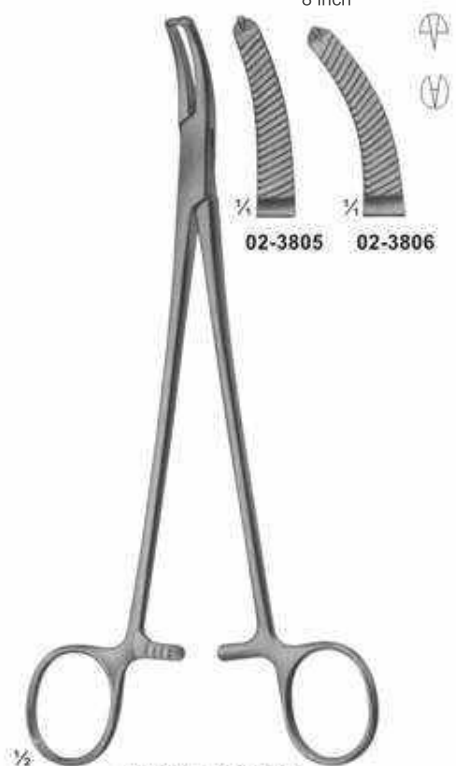

02-3805 - 02-3806
FAURE
 205 mm
 20.5cm
 8 inch

Hysterectomy and Haemostatic Forceps

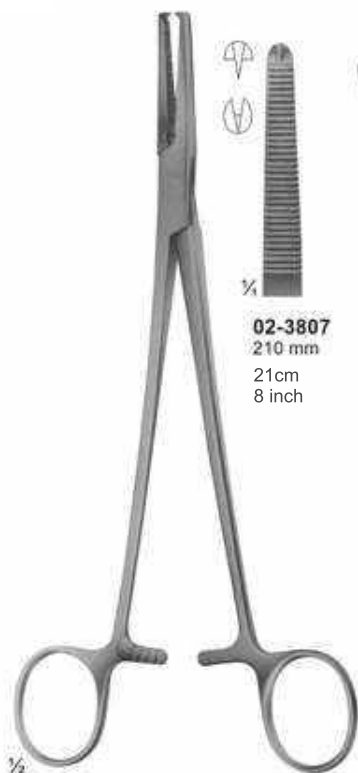

02-3807 - 02-3808
PHANEUF

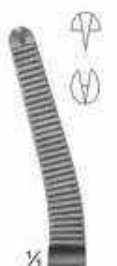

02-3808
205 mm
20.5cm
8 inch



02-3809 - 02-3810
HEANEY modif.



02-3810
245 mm
24.5cm
10 inch



02-3811
HEANEY



02-3812
WERTHEIM



02-3813
235 mm
23.5cm
9 inch

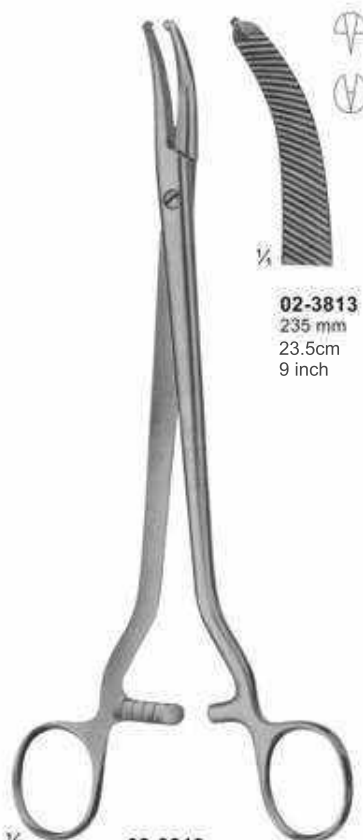

02-3813
WERTHEIM



02-3814
WERTHEIM



02-3814
245 mm
24.5cm
10 inch

Atraumata Hysterectomy Forceps and Vaginal Clamps ATRAUMATA



02-3815 - 02-3818
HEANEY



02-3815
225 mm
22.5cm
8 inch



02-3816
220 mm
22cm
8 inch



02-3817
215 mm
21.5cm
8 inch



02-3818
205 mm
20.5cm
8 inch



02-3819 - 02-3822
WERTHEIM
Parametrium clamps



02-3819
250 mm
25cm
10 inch



02-3820
245 mm
24.5cm
10 inch



02-3821
240 mm
24cm
9 inch



02-3822
220 mm
22cm
9 inch

Hysterectomy Forceps and Vaginal Clamps and Compression Forceps ATRAUMATA



02-3823
WERTHEIM
 Hysterectomy Forceps
 255 mm
 25.5cm
 10 inch

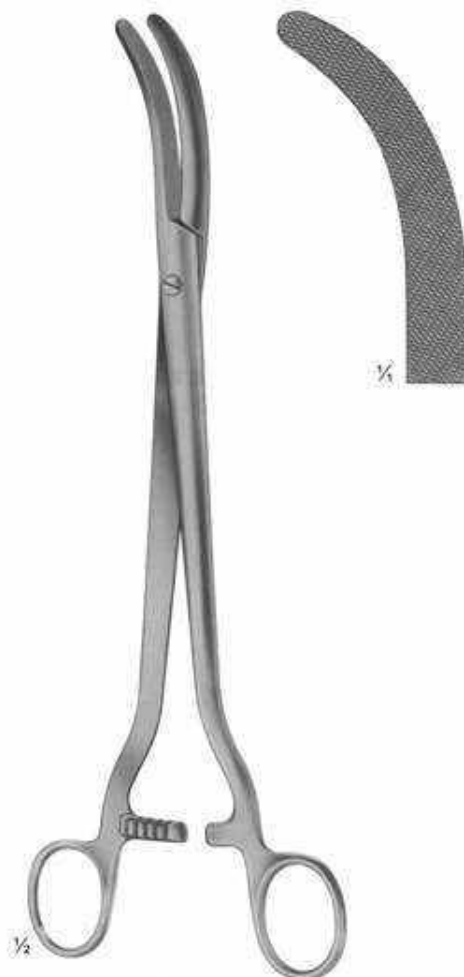

02-3824
WERTHEIM
 Parametrium Clamp
 260 mm
 26cm
 10 inch



02-3825 - 02-3827
DICK

02-3825 255 mm 25.5cm 10 inch	02-3826 265 mm 26.5cm 10 inch	02-3827 275 mm 27.5cm 11 inch
---	---	---

Clamps and Compression Forceps

ATRAUMATA

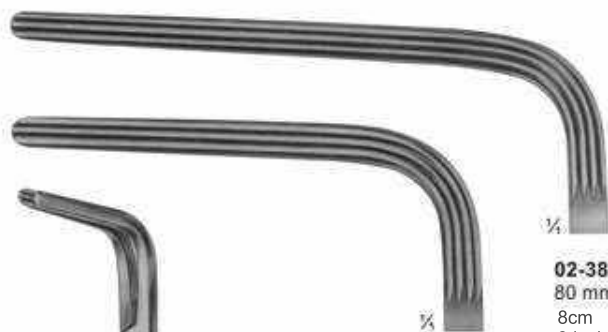

02-3830
 60 mm
 6cm
 2 inch



Needle Holders For Micro Surgery



02-3832
ROHRSCNEIDER
 With copper inserts
 100 mm
 10cm
 4 inch



02-3833
KALT
 With catch
 135 mm
 13.5cm
 5 inch



02-3834
ARRUGA
 With catch
 135 mm
 13.5cm
 5 inch



02-3835 - 02-3836
CASTROVIEJO
 With catch
 145 mm
 14.5cm
 6 inch



02-3837 - 02-3838
CASTROVIEJO
 With Catch
 160 mm
 16cm
 6 inch



02-3839 - 02-3840
 Without catch
 185 mm
 18.5cm
 7 inch



02-3841 - 02-3842
JACOBSON
 185 mm
 18.5cm
 7 inch

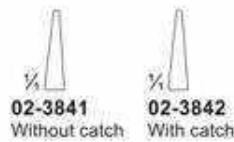

02-3843
 Without catch
 195 mm
 19.5cm
 8 inch



02-3844 - 02-3845
YASARGIL
 With catch
 200 mm / 20cm / 6 inch

Micro Needle Holders With Round Handles and Bayonet - Shaped



02-3846 02-3847
115 mm 135 mm

02-3846 - 02-3847
BARRAQUER
Without catch



02-3848 02-3849

02-3848 - 02-3849
BARRAQUER
Without catch
120 mm



02-3850 02-3851

02-3850 - 02-3851
BARRAQUER
With catch
120 mm
12cm
5 inch



02-3852

02-3852 - 02-3853
With Catch
150 mm
15cm
6 inch



02-3853

02-3854
MULLER
With Locking
Mechanism
145 mm
14.5cm
6 inch



02-3857 02-3858

02-3857 - 02-3858
YASARGIL
200 mm
20cm
6 inch

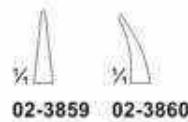

02-3859 02-3860

02-3859 - 02-3860
YASARGIL
225 mm
12.5cm
9 inch



02-3855 02-3856

02-3855 - 02-3856
BROCK
Without catch
150 mm
15cm
6 inch



02-3861
YASARGIL
245 mm/24.5cm/ 10 inch

Needle Holders



½
02-3862
CONVERSE
 125 mm
 12.5cm
 5 inch



Smooth jaws

½
02-3863
WEBSTER
 125 mm/12.5cm / 5 inch



02-3864

Smooth jaws

½
02-3864 - 02-3865
HALSEY
 130 mm
 13cm
 5 inch



02-3865

½
02-3866
DERF
 125 mm
 12.5cm
 5 inch



½
02-3867
DOYEN
 125 mm/12.5cm / 5 inch



½
02-3868
BAUMGARTNER
 145 mm / 14.5cm / 6 inch



Fine Pattern

½
02-3869
CRILE-WOOD
 150 mm/15cm / 6 inch



Heavy pattern

½
02-3870
CRILE-WOOD
 160 mm
 16cm
 6 inch



½
02-3871
CRILE-MURRAY
 150 mm
 15cm
 6 inch



½
02-3872
KILNER
 135 mm
 13.5cm
 5 inch



Designed for Frontal and Palate Suture

½
02-3873
ADSON
 175 mm/17.5cm / 9 inch

Needle Holders



02-3874
 150 mm
 15cm
 6 inch

02-3875
 180 mm
 18cm
 7 inch

02-3876
 200 mm
 20cm
 8 inch

02-3874 - 02-3876
 MAYO-HEGAR
 Medium fine patterns

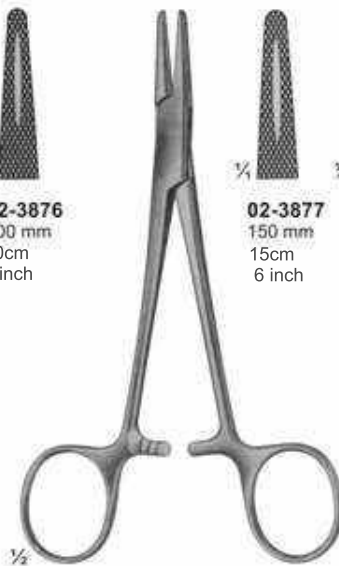

02-3877
 150 mm
 15cm
 6 inch

02-3878
 175 mm
 17.5cm
 7 inch

02-3879
 205 mm
 20.5cm
 8 inch

02-3880
 205 mm
 20.5cm
 8 inch

02-3877 - 02-3880
 HEGAR
 Heavy Patterns



02-3881
 HEANEY (HEGAR)
 200 mm/20cm /8 inch



02-3882
 JAMESON
 230 mm
 13cm
 9 inch



02-3883
 WANGENSTEEN
 275 mm
 27.5cm
 11 inch



02-3884
 MASSON
 265 mm
 26.5cm
 10 inch

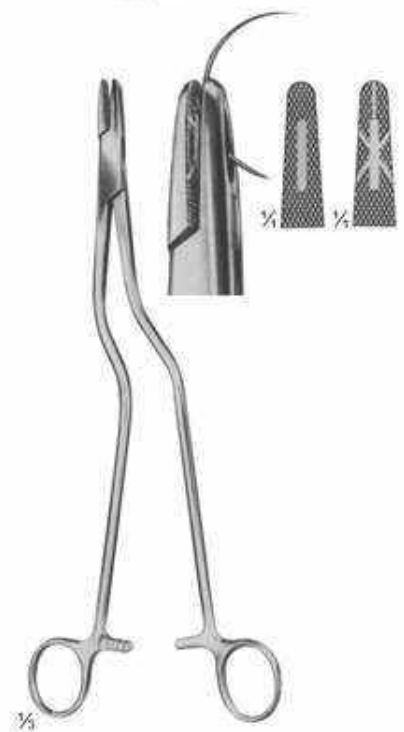

02-3885
 MASSON-LUETHY
 255 mm
 25.5cm
 10 inch

Needle Holders

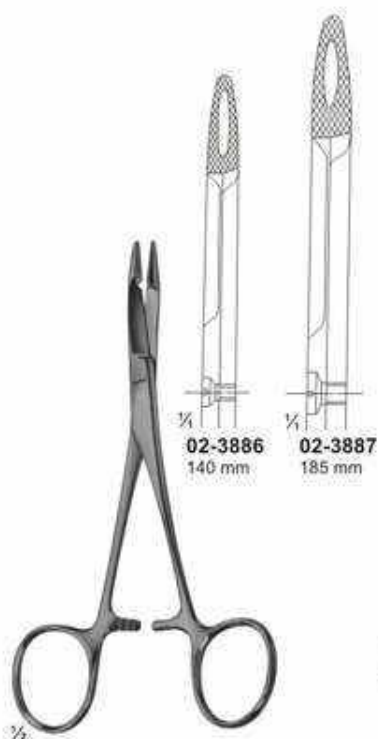

02-3886 - 02-3887
HEGAR-OLSEN
 Needle Holders with Scissors

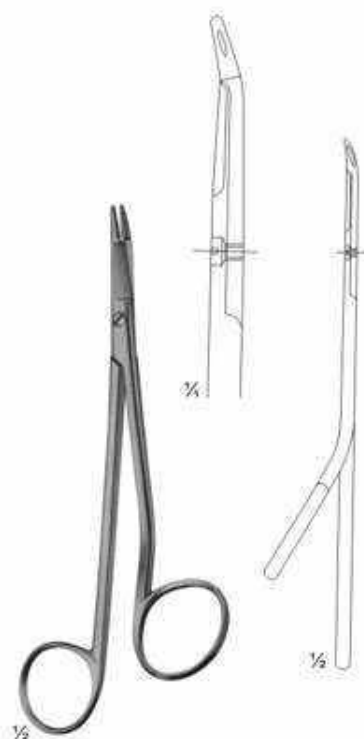

02-3888
GILLIES
 Needle Holders with Scissors
 150 mm
 15cm
 6 inch



02-3889
GILLIES
 Needle Holders with Scissors
 160 mm
 16cm
 6 inch

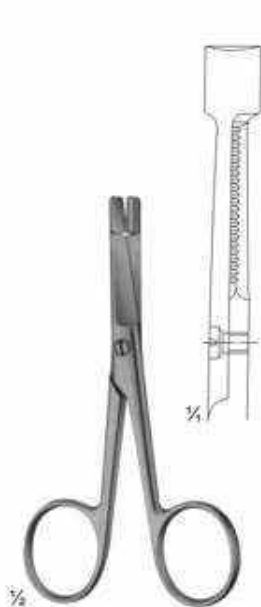

02-3890
EISELSBERG
 Needle Holders with Scissors
 115 mm
 11.5cm
 5 inch

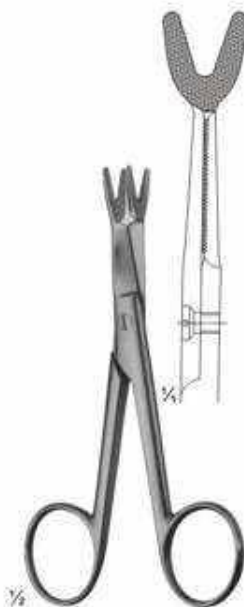

02-3891
SCHOEMAKER-LOTH
 Needle Holders with Scissors
 125 mm
 12.5cm
 5 inch



02-3892
CRILE
 150 mm
 15cm
 6 inch



02-3893
TOENNIS
 Elastic pattern for
 dura- or intestinal suture
 100 mm

Needle Holders

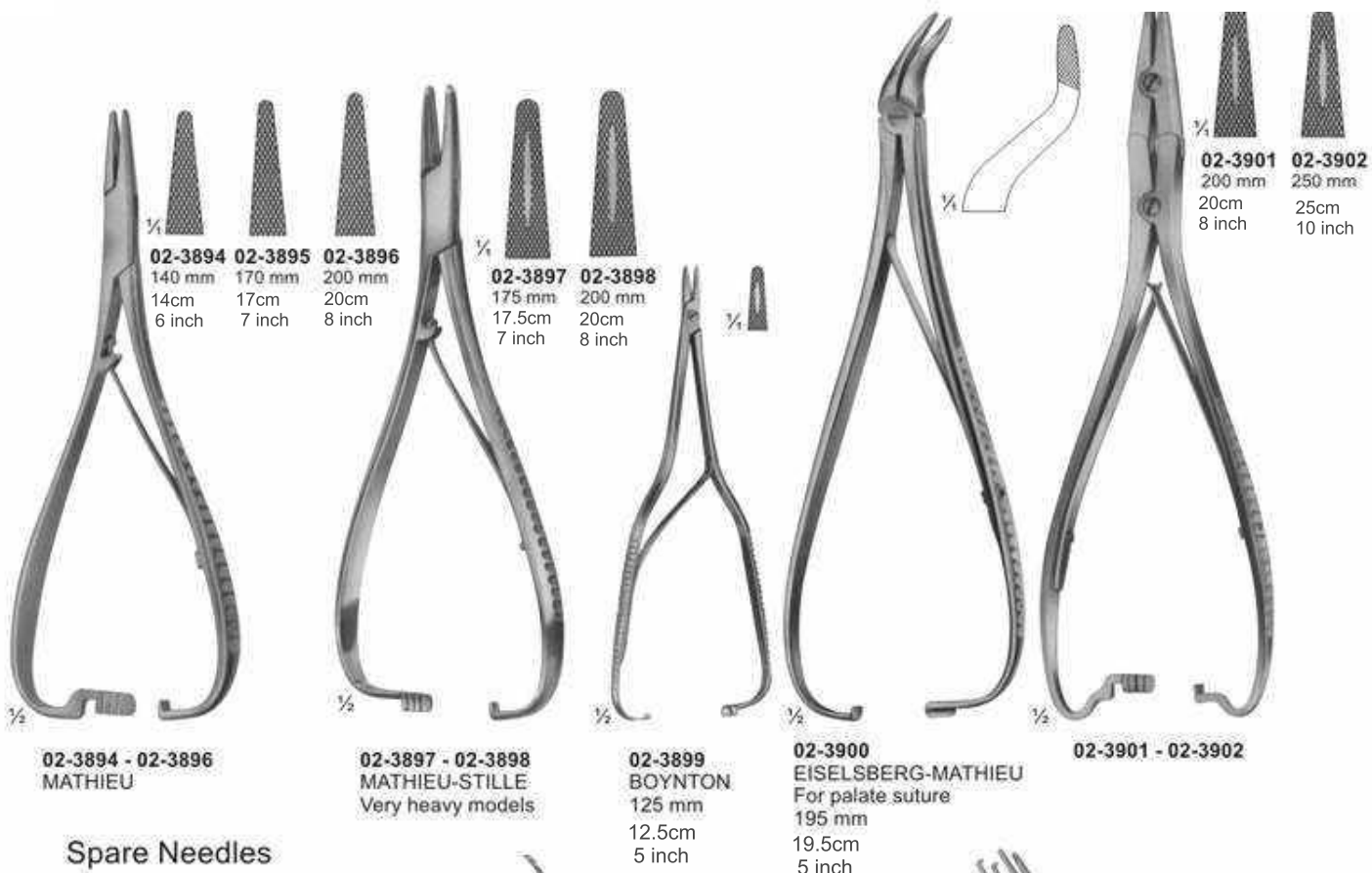

Spare Needles

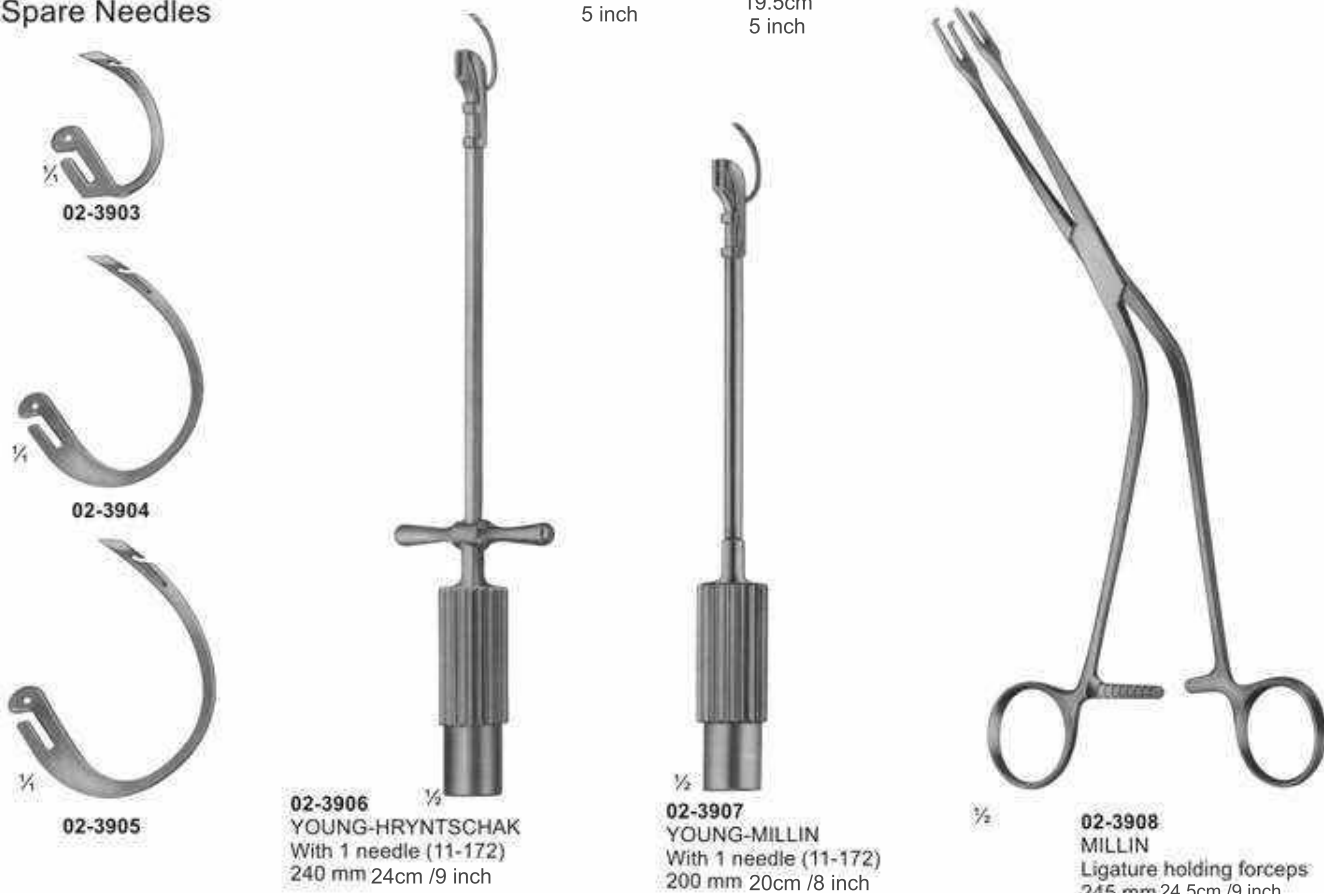

Suture Instruments - Reverdin Needles

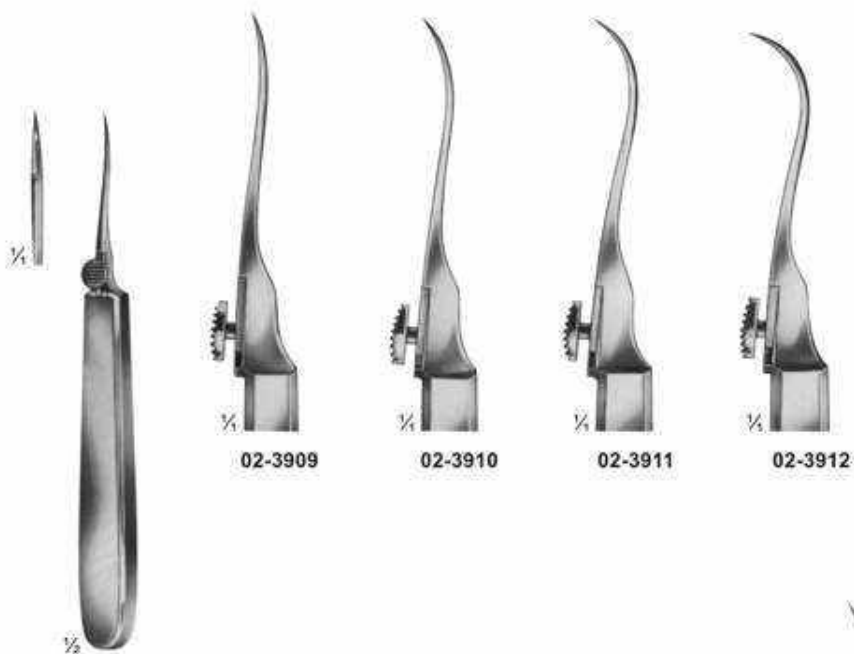

02-3909 - 02-3912
REVERDIN
140 mm
14cm
6 inch

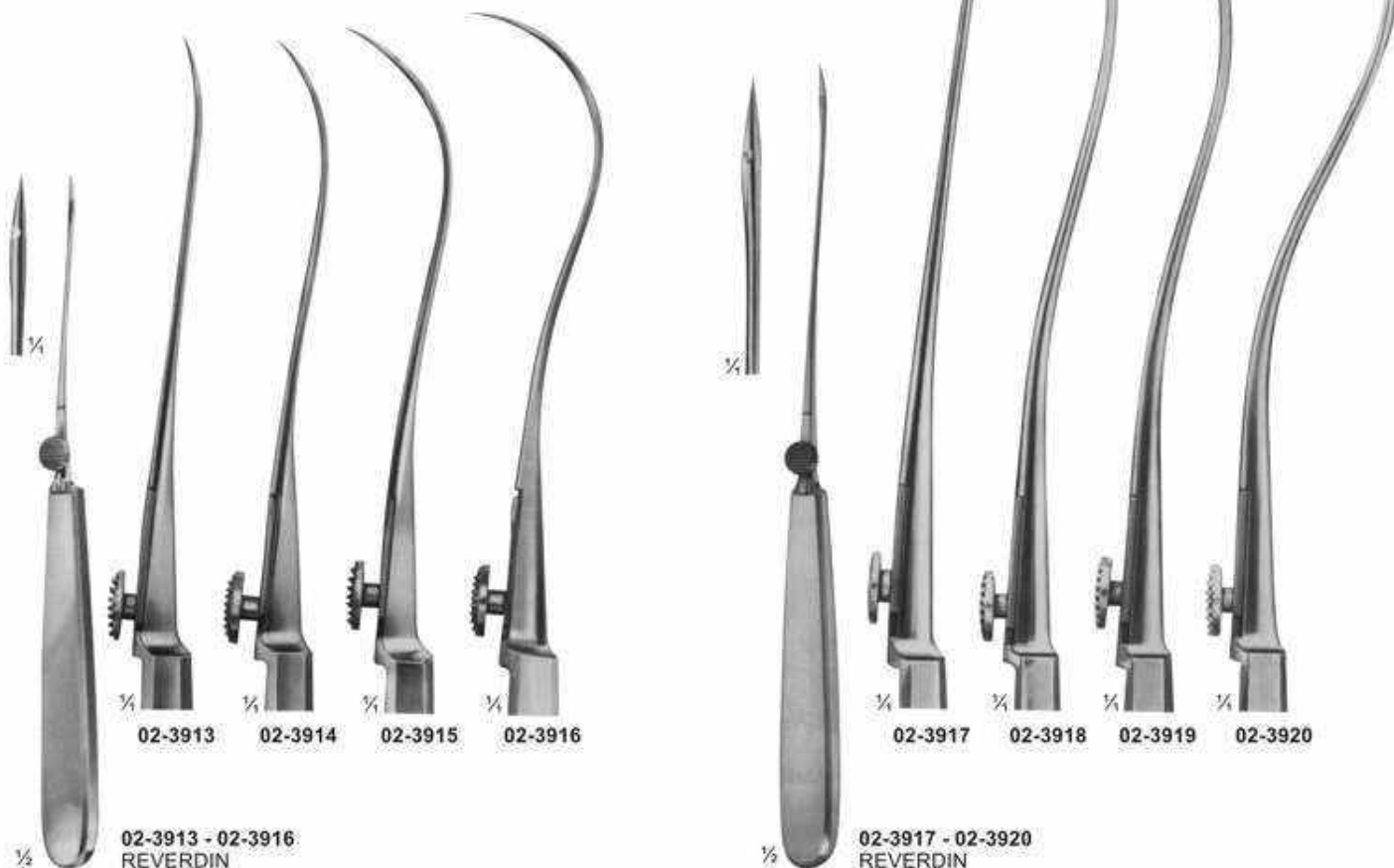

02-3913 - 02-3916
REVERDIN
195 mm
19.5cm
8 inch

02-3917 - 02-3920
REVERDIN
220 mm
22 cm
9 inch

Suture Instruments - Ligature Needles



Suture Instruments - Ligature Needles

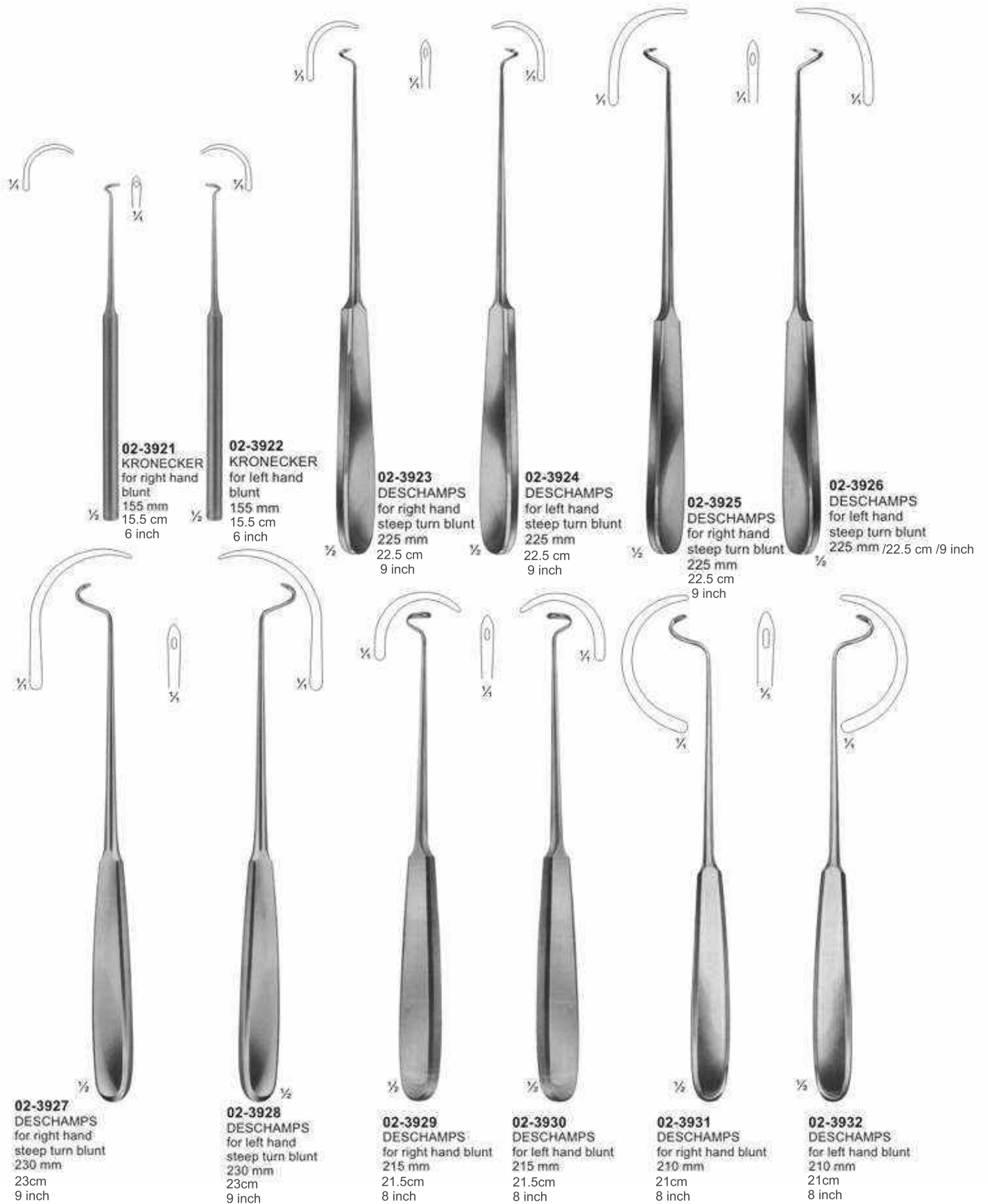

Ligature Needles



02-3943
 BRUNNER
 240 mm
 24cm
 9 inch

02-3944
 SCHMIEDEN-DICK
 Malleable / Flexible
 320 mm
 32cm
 12 inch

02-3945 - 02-3946
 BRUNNER
 Guiding Probes
 300 mm
 30cm
 12 inch



Guiding Probes and Suture Instruments



Directors and Probes



02-3962 - 02-3964
02-3962 130 mm /13cm
02-3963 145 mm /14.5cm
02-3964 160 mm /16cm
Directors



02-3965
DOYEN
145 mm /14.6cm /6 inch
Directors



02-3966
NELATON
160 mm /16cm/6 inch
Directors



02-3967
Director with tip
Diam. Of tip 3,3 mm
140 mm /14cm/6 inch

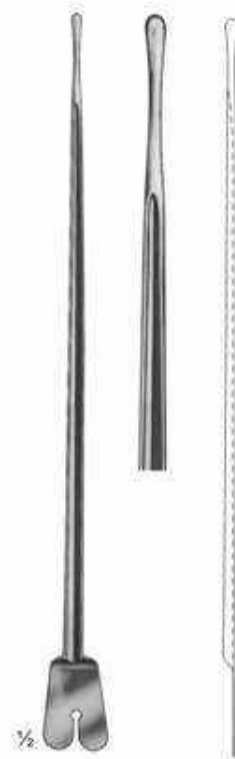

02-3968
BRODIE
Director with tip,
Diam. Of tip 3,5 mm
200 mm /20cm/8 inch



02-3969
LOCKHART-MUMMERY
165 mm /16.5cm /7 inch
Straight



02-3970
LOCKHART-MUMMERY
165 mm /16.5cm /7 inch
45° Curved

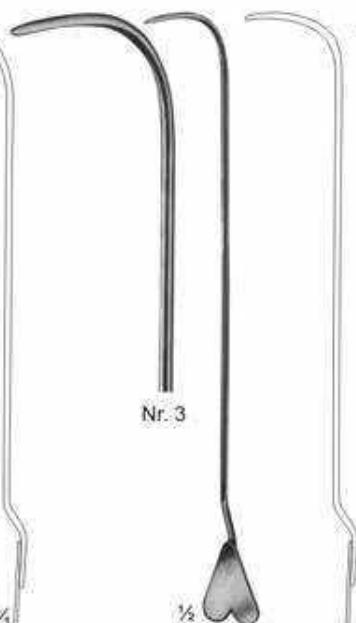

02-3971
LOCKHART-MUMMERY
165 mm /16.5cm /7 inch
90° Curved



02-3972
LOCKHART-MUMMERY
165 mm /16.5cm /7 inch
Retrograde Curved



02-3973
Director with wire
loop, malleable
190 mm /19cm /7 inch

Probes

02-3974
2,5 mm \varnothing
02-3975
2,5 mm \varnothing
02-3976
3,0 mm \varnothing



1/2

02-3974 - 02-3976
02-3974 145 mm /14.6cm /6 inch
02-3975 160 mm /16cm/6 inch
02-3976 200 mm /20cm/8 inch
 Probes with eye.

1,5 mm \varnothing



1/2

02-3977
Myrtle leaf probe
145 mm

2,0 mm \varnothing



1/2

02-3978 - 02-3982
Myrtle leaf probe
02-3978 130 mm /13cm /5 inch
02-3979 145 mm /14.6cm /6 inch
02-3980 160 mm /16cm/6 inch
02-3981 180 mm /18cm/7 inch
02-3982 200 mm /20cm/8 inch



1/2

02-3983
Probes

Diam. of tips		Length	
1 mm	2 mm	100mm	150mm
-	02-3984	-	100mm
02-3985	02-3986	02-3991	100mm
-	02-3987	02-3992	100mm
-	02-3988	02-3993	100mm
-	02-3989	02-3994	100mm
-	02-3990	-	100mm
-	02-3995	-	100mm



1/2

02-3996
Double ended probe,
malleable, diam. of tips
3 mm with hole
190 mm /19cm/8 inch



02-3997
250mm 300mm
Double ended probes,
tin, malleable, diam. of tips
3,5 mm with hole.



1/4

02-3998
Double ended probe,
tin, malleable,
diam. of tips 4 mm
400 mm /40cm/16 inch



1/2

\varnothing tip
02-3999 - 02-4001
02-3999 1,5 mm
02-4000 2,0 mm
02-4001 2,5 mm
 300 mm Probes
 30cm
 12 inch

Probes - Spatulas - Cotton Applicators



German Silver

02-4002
STACKE
 Silver
 100 mm / 10cm / 4 inch
 ∅ 0.8mm

02-4003
KILLIAN
 165 mm / 16.5cm / 6.5 inch
 ∅ 1.5mm

02-4004
 160 mm / 16cm / 6 inch
 ∅ 1.4mm

02-4005
SEIFFERT
 Silver
 180 mm / 18cm / 7 inch
 ∅ 0.5mm

02-4006
BOWMAN
 130 mm / 13cm / 5 inch

- 02-4007 - 02-4011**
- 02-4007** 0.7+0.8mm ∅ Fig. 00/0
 - 02-4008** 0.9+1.1mm ∅ Fig. 1/2
 - 02-4009** 1.3+1.4mm ∅ Fig. 3/4
 - 02-4010** 1.5+1.6mm ∅ Fig. 5/6
 - 02-4011** 1.8+1.9mm ∅ Fig. 7/8

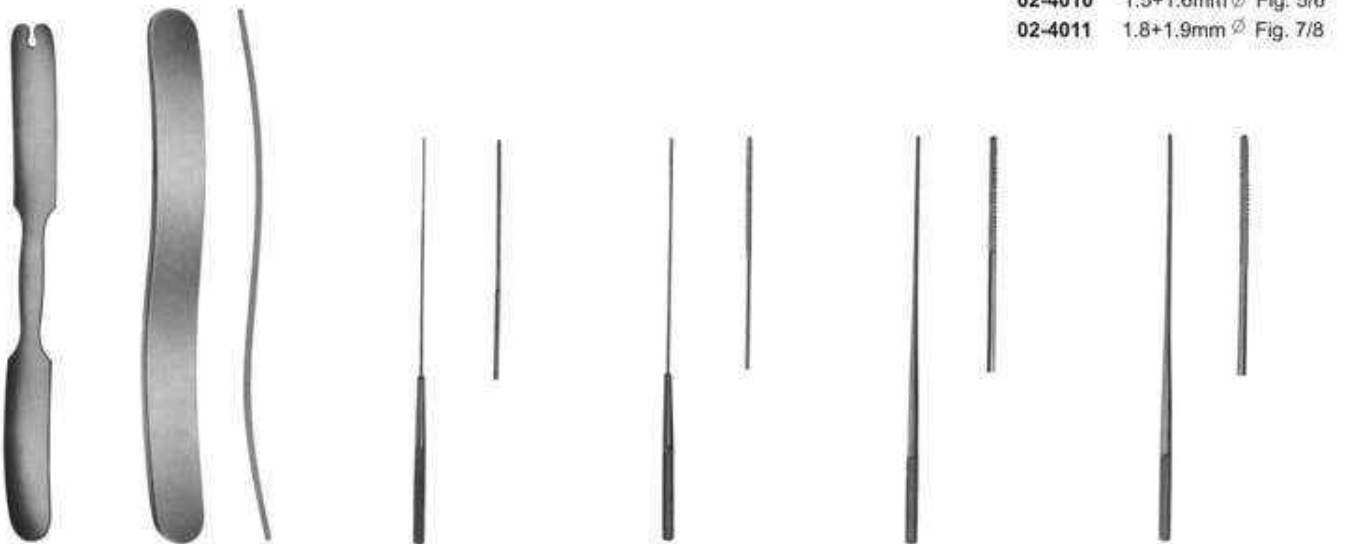

02-4012
SPATULA
 145 mm
 14.5cm
 6 inch

02-4013
SPATULA
 145 mm
 14.5cm
 6 inch

02-4014
Modell PICCOLO
 Round Serrated end
 110 mm 0.7mm

02-4015
Modell PICCOLO
 Triangular Serrated end
 110 mm 0.7mm
 11cm
 4 inch

02-4016
FARRELL
 Round Serrated end
 110 mm 1.2mm
 11cm
 4 inch

02-4017
LATHBURY-FARRELL
 Triangular Serrated end
 110 mm 1.4mm
 11cm
 4 inch

Cotton Applicators

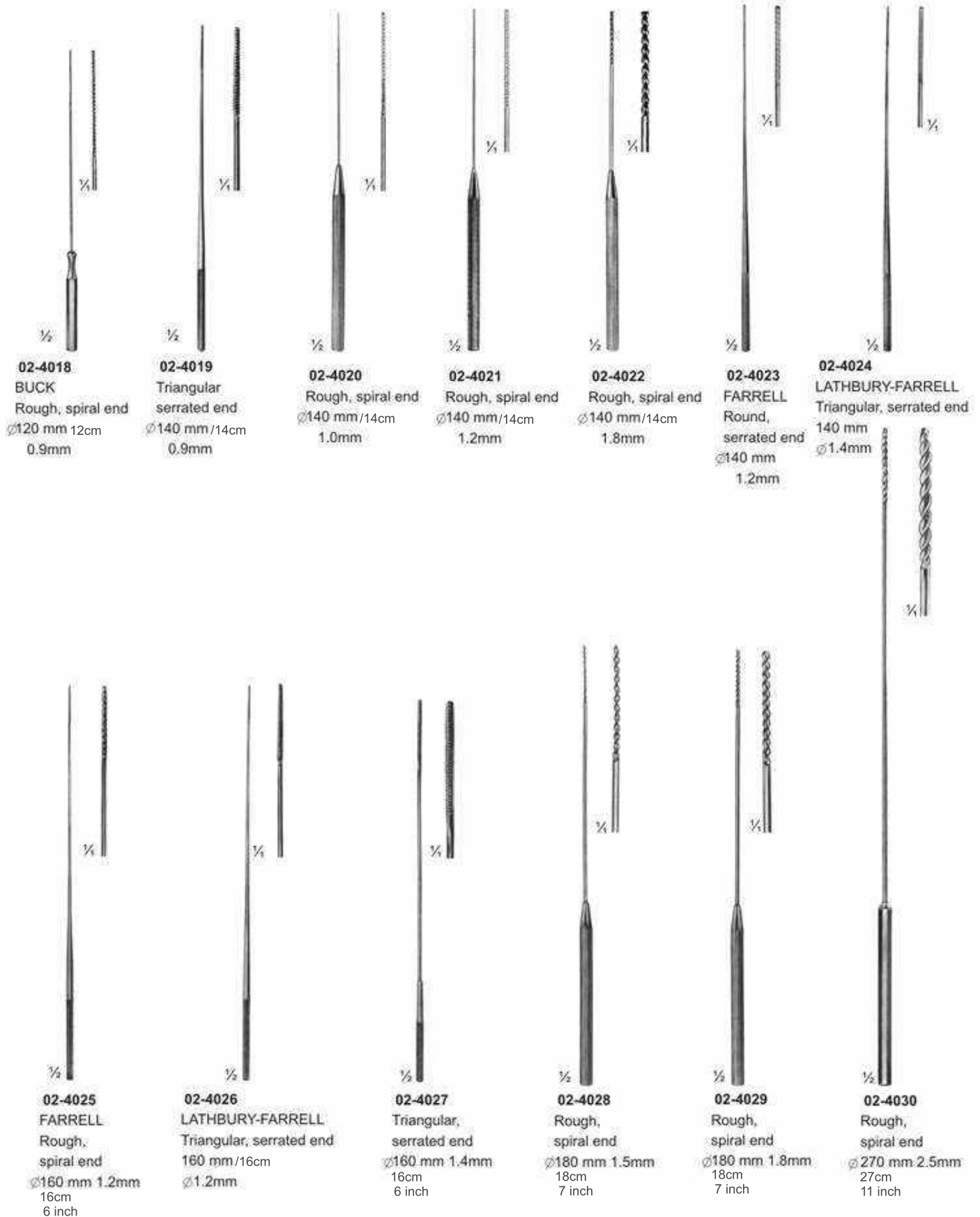

Clip Applying Forceps, Clip Applying - and Removing Forceps



02-4031
MICHEL
 125 mm
 12.5cm
 5 inch



02-4032
HEGENBARTH
 120 mm
 12cm
 5 inch



02-4033
WACHENFELDT
 120 mm
 12cm
 5 inch



02-4034
WACHENFELDT
 120 mm
 12cm
 5 inch



02-4035
MICHEL
 125 mm
 12.5cm
 5 inch



02-4036
MICHEL modif.
 130 mm
 13cm
 5 inch



02-4037
HEATH
 135 mm
 13.5cm
 5 inch

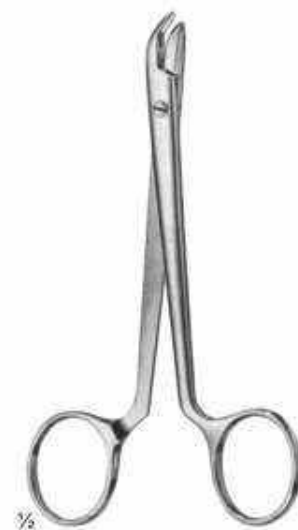

02-4038
COLLIN
 135 mm
 13.5cm
 5 inch

Suturing Instrument Set, Pocket Instrument Set



02-4039

Suturing instruments set, in metal case consisting of:
 1 michel clip applying and removing forceps,
 1 Scissors, curved, sharp/sharp, 115mm
 25 MICHEL clips, 16 x 3mm 1 Delicate tissue forceps, 130mm
 1 Scalpel, bellied 1 MATHIEU needle holder, 140mm
 1 Perforated metal case, stainless
 containing:
 1 Suture needle
 1 Suture needle
 1 Suture needle

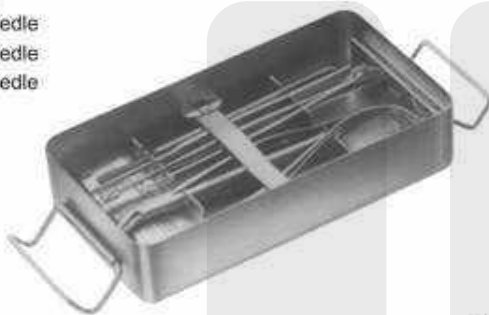

02-4040

Pocket instrument set, in metal case consisting of:

Bottom tray

1 MATHIEU needle holder, 140mm /14cm/5 inch
 1 MICHEL clip forceps, combined
 1 Myrtle leaf probe, 130mm /13cm/5 inch
 1 Sharp double curette
 1 Skin hook
 1 Detachable scalpel handle, no:4
 1 Perforated metal case, containing
 6 Scalpel blades
 1 Perforated metal case, stainless, containing
 1 Suture needle
 1 Suture needle
 1 Suture needle

Top tray

1 Tissue forceps, 130mm/13cm/5 inch
 1 KOCHER haemostatic forceps, 130mm/13cm/5 inch
 1 Straight surgical scissors, 130mm/13cm/5 inch
 1 Dissecting forceps, 130mm/13cm/5 inch
 1 FEILCHENFELD splinter forceps, 115mm/11.5cm/5 inch
 25 MICHEL clip, 16 x 3mm
 1 Flacon of suture skin, sterile in alcohol

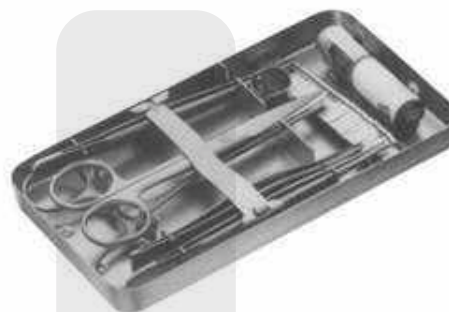

02-4041

Pocket instrument set, in metal case consisting of:

Bottom tray

1 MAYO-HEGER needle holder, 150mm /15cm/6 inch
 1 MICHEL clip forceps, combined 1 Myrtle leaf probe, 130mm
 1 Sharp double curette 1 Skin hook 1 Detachable scalpel handle, no. 4
 1 Perforated metal case, consisting
 6 Scalpel blades
 1 Perforated metal case, stainless, consisting:
 1 Suture needle
 1 Suture needle
 1 Suture needle

Top tray

1 Tissue forceps, 130mm
 1 CRILE haemostatic forceps, 140mm
 1 Straight surgical scissors, 130mm
 1 Dissecting forceps, 130mm
 1 FEILCHENFELD splinter forceps, 115mm
 25 MICHEL clip, 16 x 3mm
 1 Flacon of suture silk, sterile in alcohol



Pocket Instrument Set, Venae Sectio Set

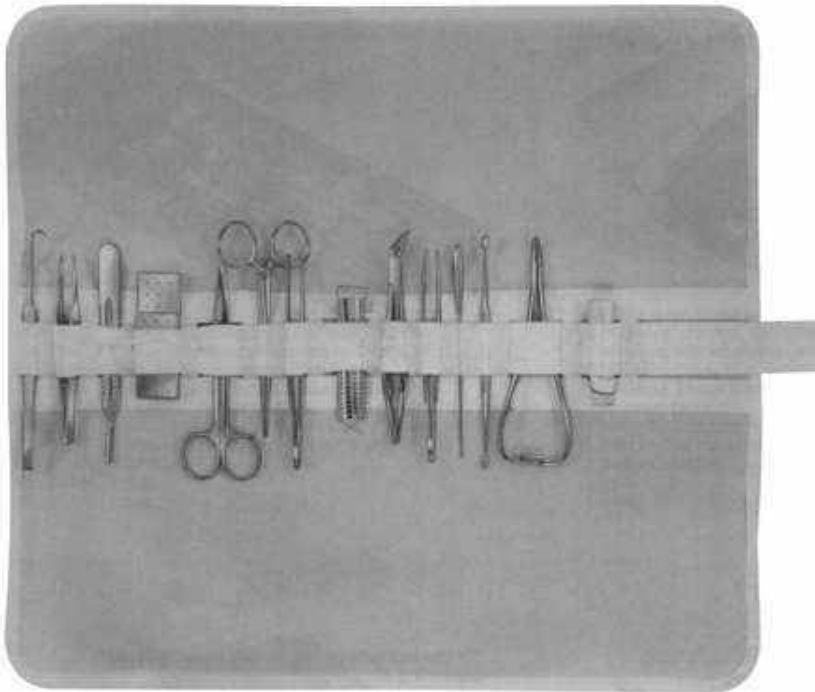

02-4042

Pocket instrument set in metal case 170 x 90mm
canvas roll only, sterilizable in autoclave.
consisting of:
1 Myrtle leaf probe, 130mm
1 Sharp double curette
1 FEILCHENFELD splinter forceps, 115mm
1 Dissecting forceps, 130mm 1 Tissue forceps, 130mm

1 Straight surgical scissors, 130mm
1 Scalpel handle no. 4
1 Perforated metal case, consisting
6 scalpel blades
1 KOCHER haemostatic forceps, 130mm
1 Skin hook
1 MATHIEU needle holder, 140mm
1 Tube of suture skin, sterile in alcohol
1 MICHEL clip forceps, 120mm



25 MICHEL clip, 16 x 3mm
1 Perforated metal case, stainless,
consisting:
1 Suture needle
1 Suture needle
1 Suture needle

02-4043

Canvas roll only, sterilizable in
autoclave

Suitable Metal Cases

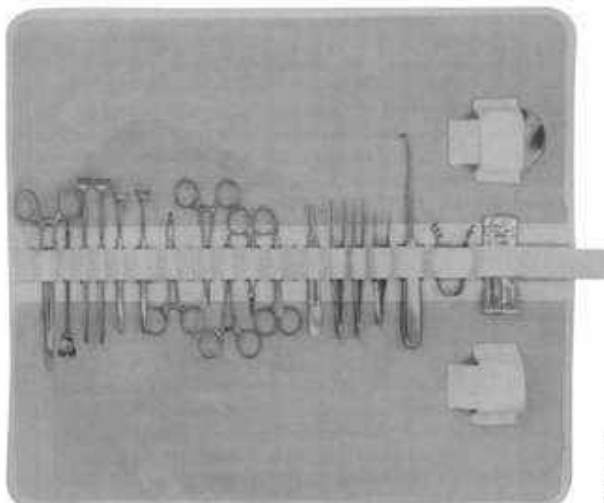

02-4044

Venae sectio set, canvas roll only, sterilizable in autoclave.
consisting of:
2 Tissue forceps, 1 x 2 teeth, 140mm
1 Dissecting forceps, 145mm
1 FEILCHENFELD splinter forceps, 115mm 1 Straight scissors, sharp, 110mm
1 Curved scissors, blunt, 115mm
3 HALSTED mosquito forceps, curved on flat, 125mm



250 x 125 x 55mm

233 x 148 x 57mm

1 DESCHAMPS needle, blunt, 210mm
1 DOYEN Director, curved, 140mm
2 Wound retractors, 4 blunt prongs, 160mm
2 DESMARRES wound retractors, 135mm
1 FINSSEN retractors, 2 x3 blunt prongs, 80mm
1 Scalpel handle no. 4
4 Sterile scalpel blades, no 18, single peel pack
1 Needle box, perforated, round, diam. 65mm
1 HEGAR-MAYO DUROGRIP needle holder, 180mm

02-4045

Canvas roll only, sterilizable in autoclave

Venae Sectio Set



02-4046

Venae sectio set, in metal case

consisting of:

Bottom tray

- 1 MATHIEU needle holder, fine pattern 140mm/14cm/5 inch
- 1 Ligature needle, fine short pattern
- 1 DOYEN director, curved
- 1 HEGENBARTH clip forceps,
- 1 ELSCHNIG tissue forceps, 1 x 2 teeth fine, 105mm/10.5cm/4 inch
- 1 Dressing forceps, fine 105mm
- 1 Tissue forceps, 1 x 2 teeth, 110mm/11cm/4 inch
- 1 Vessel scissors, straight, with 1 ball point, 110mm/11cm/4 inch
- 1 Vessel scissors, curved, pointed 105mm/10.5cm/4 inch
- 1 FINSSEN retractor
- 1 Perforated needle case

Top tray

- 1 Scalpel, pointed
- 1 Scalpel, bellied
- 2 HALSTED mosquito forceps, curved, 125mm/12.5cm/5 inch
- 2 HALSTED mosquito forceps, straight, 1x 2 teeth, 125mm
- 3 BACKHAUS towel forceps, 90mm 90cm/4 inch
- 2 Flacon holder

Section - 03



DENTELO SURGICAL[®]
INTERNATIONAL
Serving World of Surgical Since 1996.



- ★ Hooks, Retractors, Spatulas, Spreaders, Abdoninal Retractors
- ★ Forceps, intestinal Clamps, Specula, Biopsy Forceps, Anuscopes
- ★ Gall Duct Forceps / Probes / Scissors / Kidney Forceps, Urinary Instruments, Trocars

Pages 122-217

Nerve - and Vessel Hooks



Nerve - and Vessel Hooks

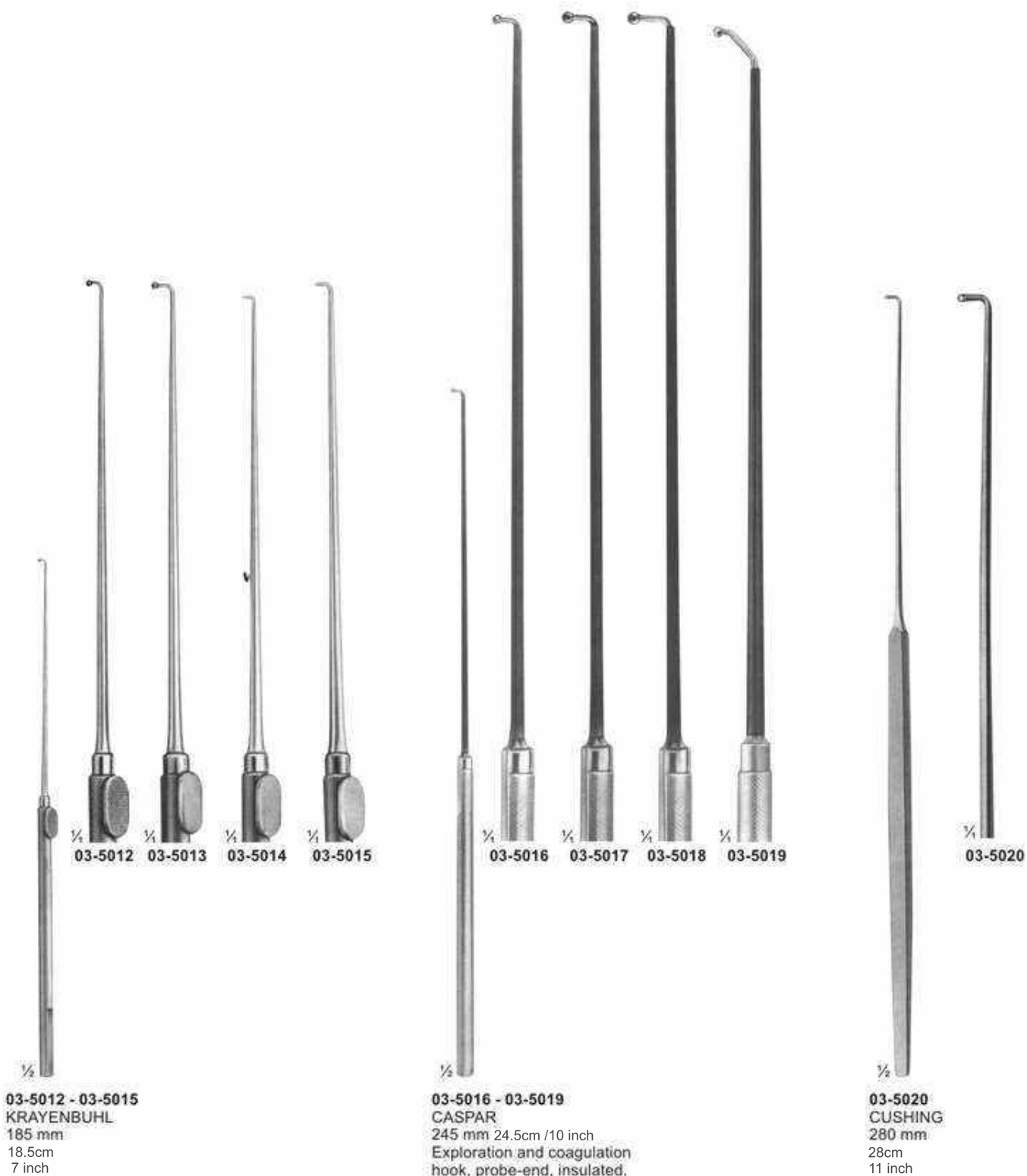

03-5012 - 03-5015
KRAYENBUHL
 185 mm
 18.5cm
 7 inch

03-5016 - 03-5019
CASPAR
 245 mm 24.5cm /10 inch
 Exploration and coagulation
 hook, probe-end, insulated.

03-5020
CUSHING
 280 mm
 28cm
 11 inch



Fine Wound Retractors (Dura- and Skin Retractors)



03-5021 - 03-5022
03-5021 Sharp
03-5022 Blunt
GRAEFE
125 mm
12.5cm
5 inch



03-5023 - 03-5024
03-5023 125 mm
03-5024 130 mm
Sharp
GUTHRIE



03-5025 - 03-5027
03-5025 130 mm
03-5026 135 mm
Sharp
03-5027 135 mm
Blunt 13.5cm
ROLLET 5 inch



03-5028
FRAZIER
Dura Retractor
130 mm
13cm
5 inch



03-5029
TOENNIS
Dura Retractor
150 mm
15cm
6 inch



03-5030
KILNER
160 mm
16cm
6 inch



03-5031
FREER
150 mm
15cm
6 inch



03-5032
MULLER
150 mm
15cm
6 inch



03-5033
MULLER
150 mm
15cm
6 inch



03-5034
COTTLE
160 mm
16cm
6 inch



03-5035
COTTLE
160 mm
16cm
6 inch



03-5036
JAEGER
135 mm
13.5cm
5 inch



03-5037 - 03-5040
JOSEPH
165 mm
16.5cm
6 inch



03-5037

03-5038
3 mm

03-5039
6 mm

03-5040
8 mm



03-5041

03-5042

3 X 11 mm

7 X 12 mm

8 X 12 mm

03-5041 - 5042
GILLIES
180 mm
18cm
7 inch

03-5043
KILNER
Sharp
80 mm
8cm
3 inch

03-5044
CONVERSE
Blunt
120 mm
12cm
5 inch

Wound - Trachea Retractors

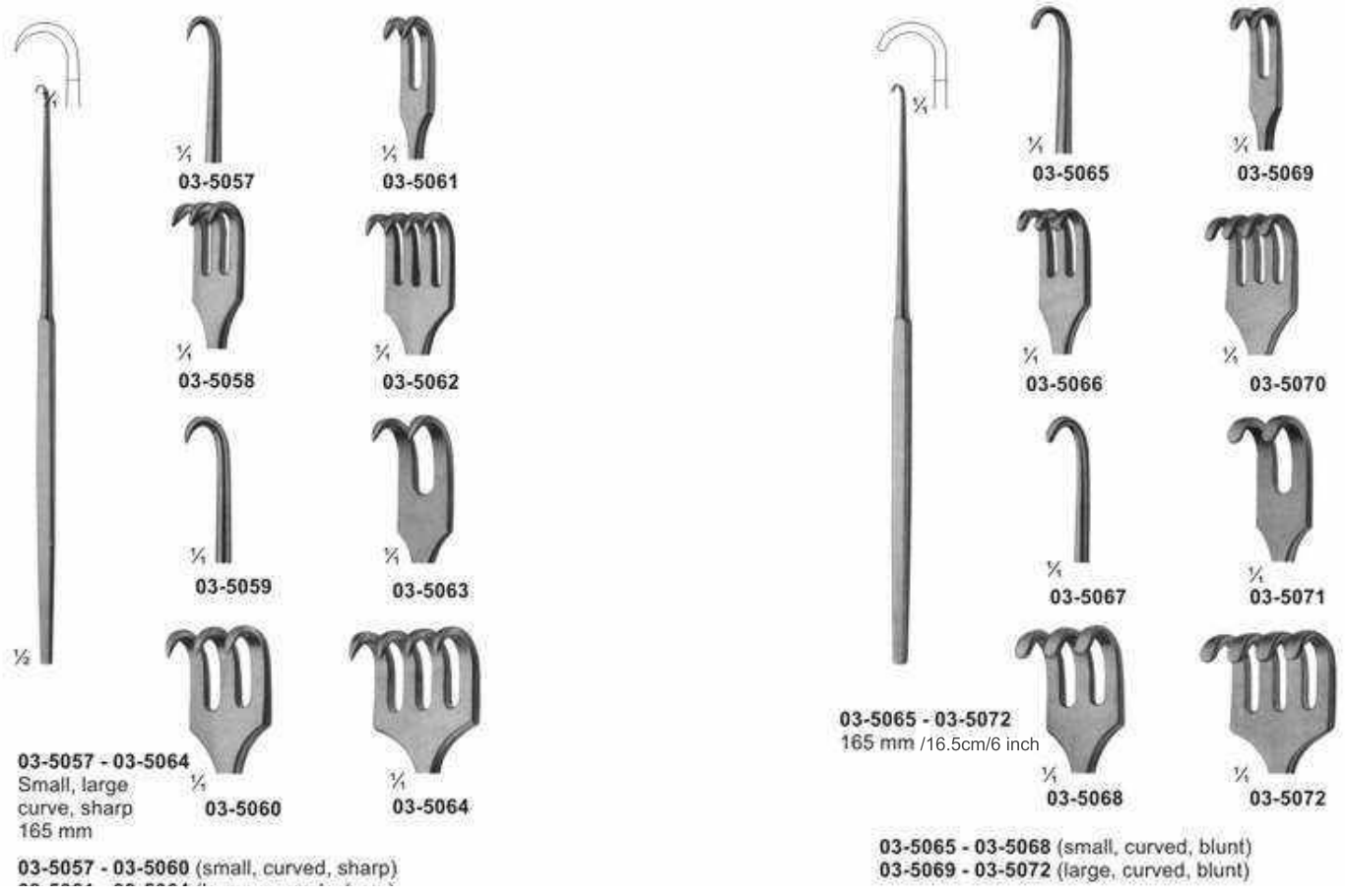

Retractors With Treangle Handle



03-5073
MANNERFELT modif.
sharp
135 mm / 13.5cm / 5 inch



03-5074
MANNERFELT modif.
sharp
155 mm / 15cm / 6 inch



03-5075
MANNERFELT modif.
sharp
155 mm / 15cm / 6 inch



03-5076 - 03-5078
MANNERFELT modif.
Small curve, sharp
155 mm / 15cm / 6 inch



03-5079 - 03-5081
MANNERFELT modif.
Large curve, blunt
155 mm / 15cm / 6 inch



03-5082 - 03-5085
LANGENBECK-
MANNERFELT modif.
155 mm / 15cm / 6 inch



03-5086 - 03-5088
MANNERFELT modif.
Saddle hooks.
155 mm / 15cm / 6 inch



03-5089
MANNERFELT modif.
Saddle hooks, fenestrated
155 mm / 15cm / 6 inch



Retractors



03-5090
FOMON
 145 mm /14.5cm/ 6 inch



03-5091 - 03-5092
 160 mm /16cm/ 6 inch



03-5093 - 03-5094
LANGENBECK-GREEN
 160 mm /16cm/ 6 inch



03-5095
 160 mm /16cm/ 6 inch



03-5096 - 03-5101
MEYERDING
 Fig. A - Fig. F
 180 mm /18cm/ 7 inch



03-5096
 18 x 7 mm

03-5097
 16 x 5 mm

03-5098
 7 x 4 mm

03-5099
 5 x 10 mm

03-5100
 11 x 4 mm

03-5101
 6 x 4 mm



03-5102
 4 x 7 mm

03-5103

03-5104

03-5102 - 03-5104
WILLIGER
 120 mm /12cm/ 5 inch

Retractors



03-5105
EMMET
 Fistula hook
 220 mm
 22cm
 9 inch



03-5106
SIMON
 Fistula hook
 220 mm / 22cm / 9 inch

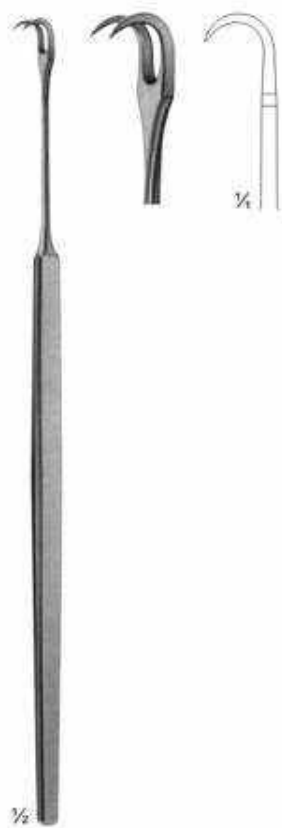

03-5107
SIMON
 Fistula hook
 220 mm / 22cm / 9 inch



03-5108
LANGE
 Fistula hook
 230 mm / 23cm / 9 inch



03-5109 - 03-5110
 Tendon hooks
 175 mm
 17.5cm
 7 inch

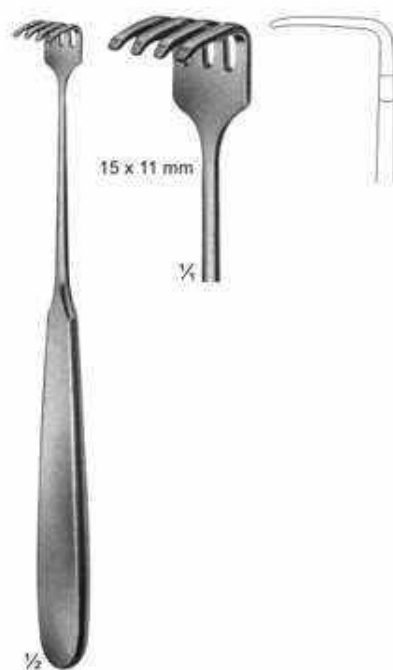

03-5111
KLAPP
 Tendon hooks
 175 mm
 17.5cm
 7 inch



Wound and Vein Retractors



Retractors



Retractors



Bone Retractors and Retractors



03-5155
KOCHER
Sharp
205 mm
20.5cm
8 inch



03-5156
KOCHER
Sharp
220 mm
22cm
9 inch



03-5157
VOLKMANN
Sharp
220 mm
22cm
9 inch



03-5158
VOLKMANN
Blunt
220 mm
22cm
9 inch



03-5159
VOLKMANN
Sharp
220 mm
22cm
9 inch



03-5160 - 03-5167
VOLKMANN
225 mm
22.5cm
9 inch

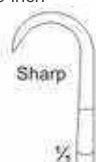

03-5160
9 x 8 mm



03-5161
9 x 13 mm



03-5162
9 x 19 mm



03-5163
9 x 29 mm



03-5164
8.5 x 8 mm



03-5165
8.5 x 13 mm



03-5166
8.5 x 19 mm



03-5167
8.5 x 29 mm

Retractors



Retractors, Deep form



03-5190 - 03-5191
KOERTE
Handle vertical
to the blade.
240 mm
24cm
9 inch



03-5192 - 03-5195
ISRAEL
255 mm
25.5cm
10 inch

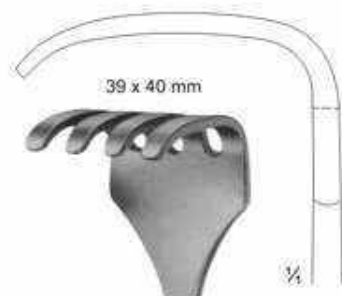

03-5192
4 Prongs, blunt



03-5193
5 Prongs, blunt



03-5194
6 Prongs, blunt

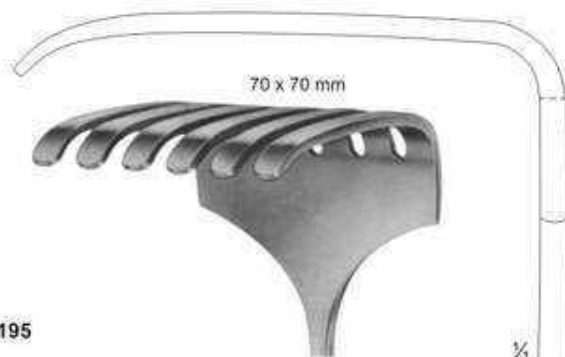

03-5195
6 Prongs, blunt

Retractors



03-5196 - 03-5201
LANGENBECK
 210 mm

03-5196	28 x 10 mm
03-5197	28 x 14 mm
03-5198	33 x 14 mm
03-5199	28 x 16 mm
03-5200	40 x 10 mm
03-5201	40 x 13 mm



03-5202 - 03-5210
KOCHER-LANGENBECK
 215 mm

03-5202	25 x 6 mm
03-5203	35 x 8 mm
03-5204	35 x 11 mm
03-5205	35 x 15 mm
03-5206	41 x 11 mm
03-5207	55 x 11 mm
03-5208	70 x 14 mm
03-5209	80 x 12mm
03-5210	80 x 16mm



03-5211
LANGENBECK
 215 mm
 21.5cm
 8 inch

Retractors



1/4

03-5212 - 03-5216
KOCHER
 230 mm 23cm /9 inch



1/2

03-5217 - 03-5219
SAUERBRUCH
 225 mm
 22.5cm
 9 inch



03-5212
 40 x 18 mm

1/4



03-5213
 60 x 20 mm

1/4

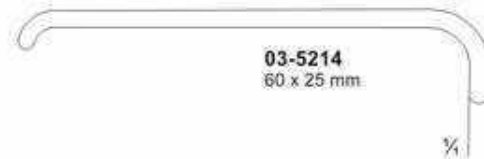

03-5214
 60 x 25 mm

1/4



03-5215
 75 x 30 mm

1/4



03-5216
 75 x 40 mm

1/4



03-5217
 46 x 16 mm

1/4



03-5218
 55 x 22 mm

1/4



03-5219
 72 x 19 mm

1/4

Retractors

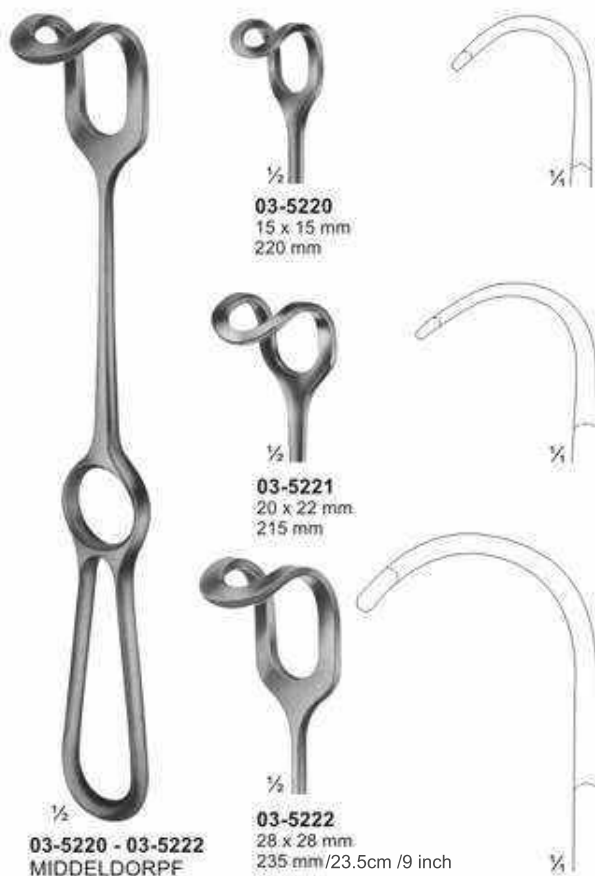

Retractors



1/4

03-5226 - 03-5231
 HOSEL
 250 mm
 21.5cm
 9 inch



03-5226
 60 x 20 mm

1/4

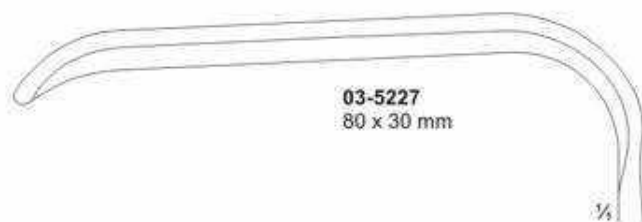

03-5227
 80 x 30 mm

1/4

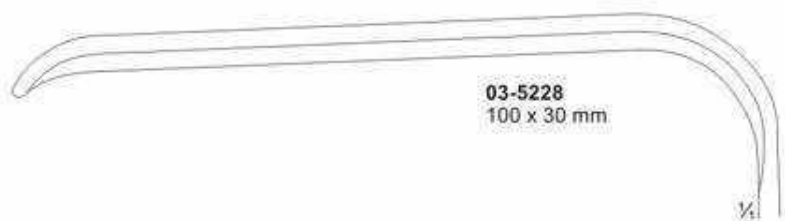

03-5228
 100 x 30 mm

1/4

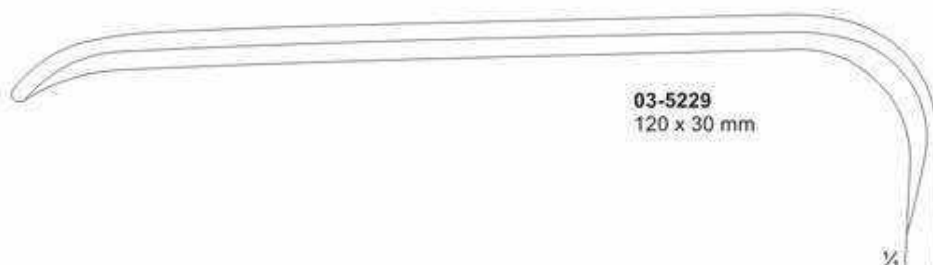

03-5229
 120 x 30 mm

1/4

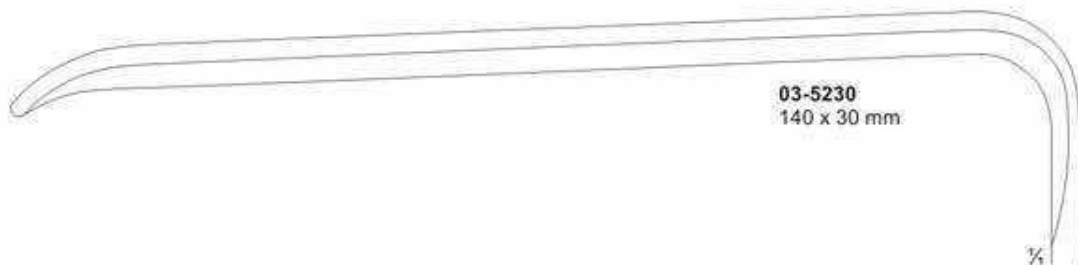

03-5230
 140 x 30 mm

1/4

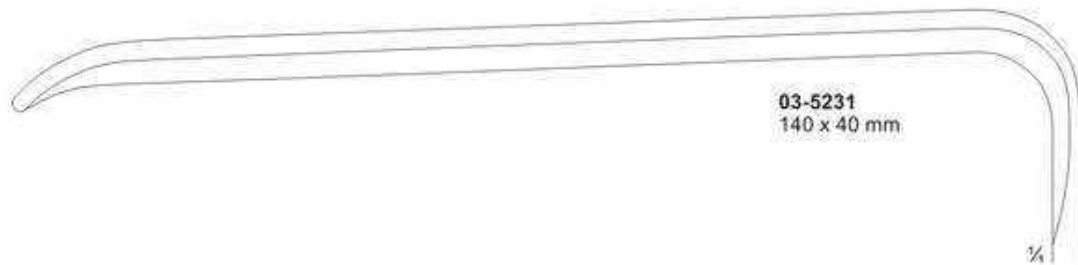

03-5231
 140 x 40 mm

1/4

Retractors

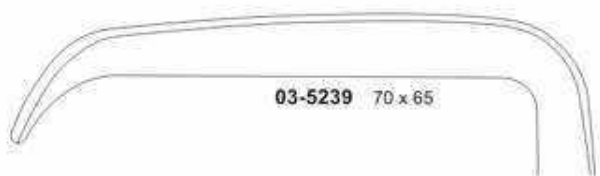

03-5239 70 x 65

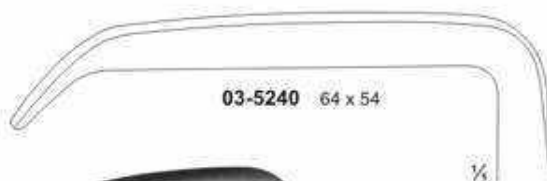

03-5240 64 x 54



1/2

03-5239 - 03-5240
KELLY
 260 mm
 26cm
 10 inch



03-5241 70 x 50
 03-5242 70 x 65



1/2

03-5241 - 03-5242
MORRIS
 245 mm
 24.5cm
 10 inch

Retractors

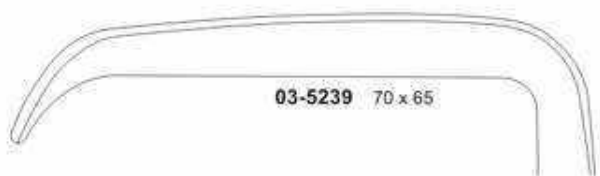

03-5239 70 x 65

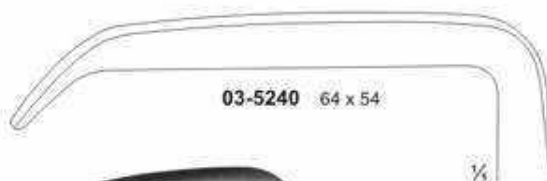

03-5240 64 x 54



1/2

03-5239 - 03-5240
KELLY
 260 mm
 26cm
 10 inch



03-5241 70 x 50
 03-5242 70 x 65



1/2

03-5241 - 03-5242
MORRIS
 245 mm
 24.5cm
 10 inch

Retractors For Deep Surgery



Retractors For Deep Surgery



Retractors, Vario Retractor System, Germ. Fed. Patent, Germ. Fed. Regd.Des, US-Patent.

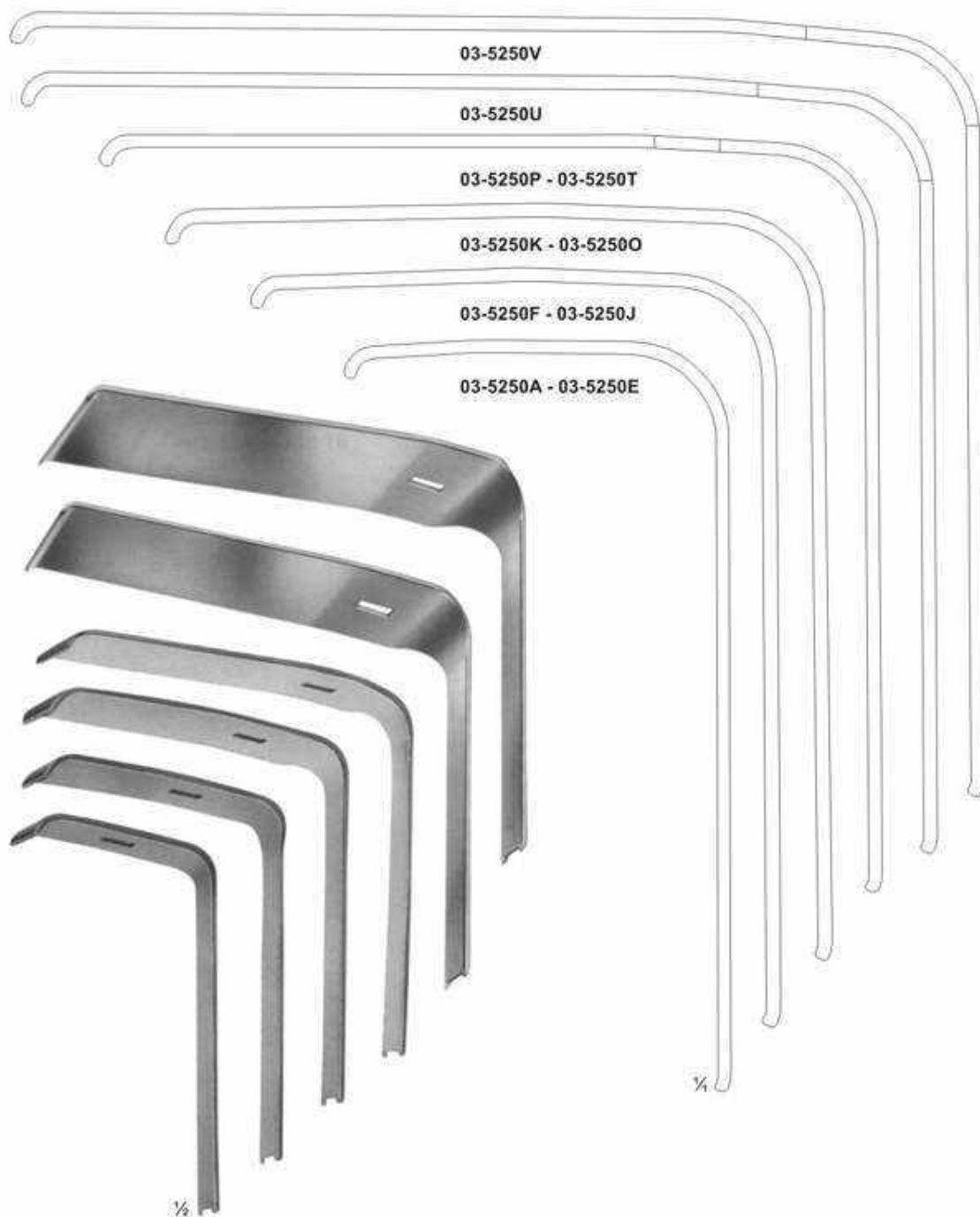

Retractor blades for handles 03-5250

Depth	Width	Width						50mm
		14mm	18mm	22mm	26mm	30mm	40mm	
5.5cm	55mm	03-5250A	03-5250B	03-5250C	03-5250D	03-5250E	-	
7.5cm	75mm	03-5250F	03-5250G	03-5250H	03-5250I	03-5250J	-	
9.5cm	95mm	03-5250K	03-5250L	03-5250M	03-5250N	03-5250O	-	
11.5cm	115mm	03-5250P	03-5250Q	03-5250R	03-5250S	03-5250T	-	
13.5cm	135mm	-	-	-	-	03-5250U	-	
14.5cm	145mm	-	-	-	-	-	03-5250V	

Retractors, Vario Retractor System, Germ. Fed
 Patent, Germ. Fed. Regd.Des, US-Patent.



03-5251 - 03-5257
BRUNNER
 275 mm/27.5cm /11 inch

03-5251	80 x 20
03-5252	100 x 25
03-5253	120 x 25
03-5254	130 x 30
03-5255	140 x 30
03-5256	160 x 30
03-5257	180 x 30

1/2



03-5258
 Handle with cold
 light carrier for
 retractor blades.
 280 mm
 28cm
 11 inch

Retractors, Lung Spatulas

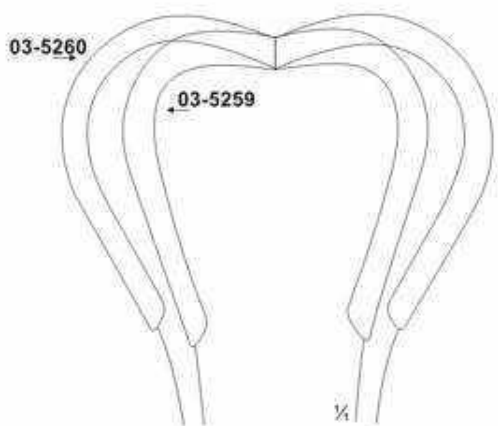

03-5259 - 03-5260
HARRINGTON
 03-5259 123 x 45 mm
 03-5260 123 x 64 mm
 Flexible
 295 mm / 29.5cm / 12 inch



03-5261
ALLISON
 255 mm
 25.5cm
 10 inch



03-5262
ALLISON
 320 mm
 32cm
 12 inch

Retractors, Lung Spatulas



Retractors, Lung Spatulas



Retractors, Lung Spatulas



03-5274
 DEAVER
 300 mm / 30cm / 12 inch
 Fig. 3

03-5275
 DEAVER
 310 mm / 31cm / 12 inch
 Fig. 4

03-5276
 DEAVER
 320 mm / 32cm / 12 inch
 Fig. 5

Retractors, Lung Spatulas



03-5277
 DEEVER
 310 mm/31cm /12 inch
 Fig. 1



03-5278
 DEEVER
 310 mm/31cm /12 inch
 Fig. 3

Retractors, Lung Spatulas



03-5279
DEAVER
305 mm /31cm /12 inch
Fig. 4

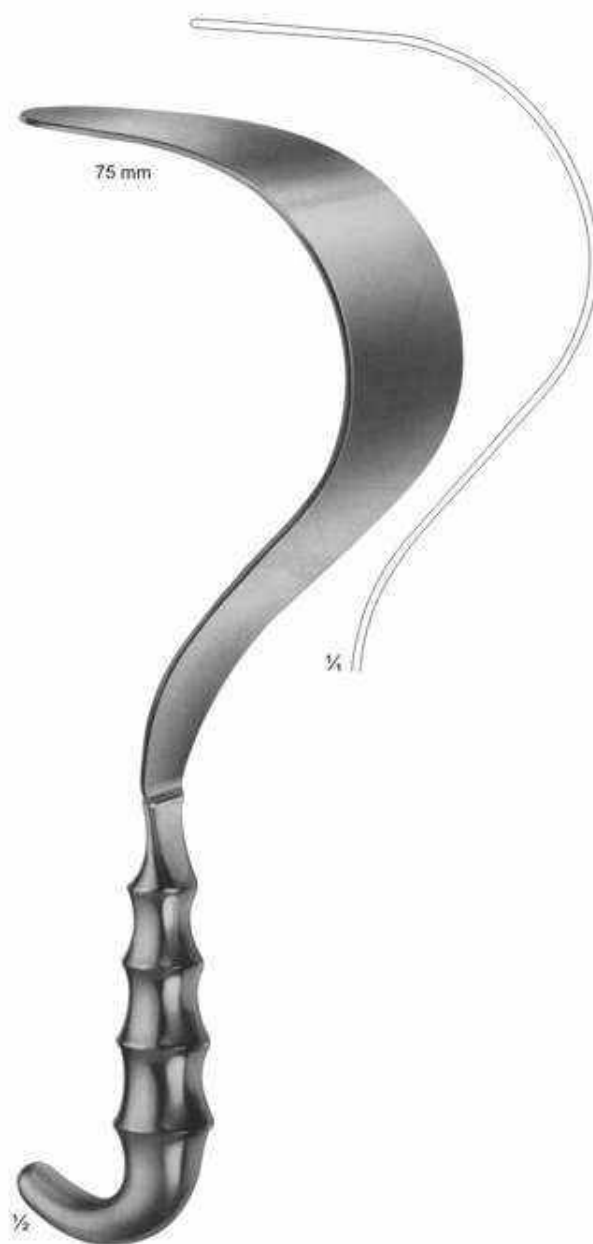

03-5280
DEAVER
310 mm /31cm /12 inch
Fig. 5

Retractors For Deep Surgery (Abdominal Retractors)

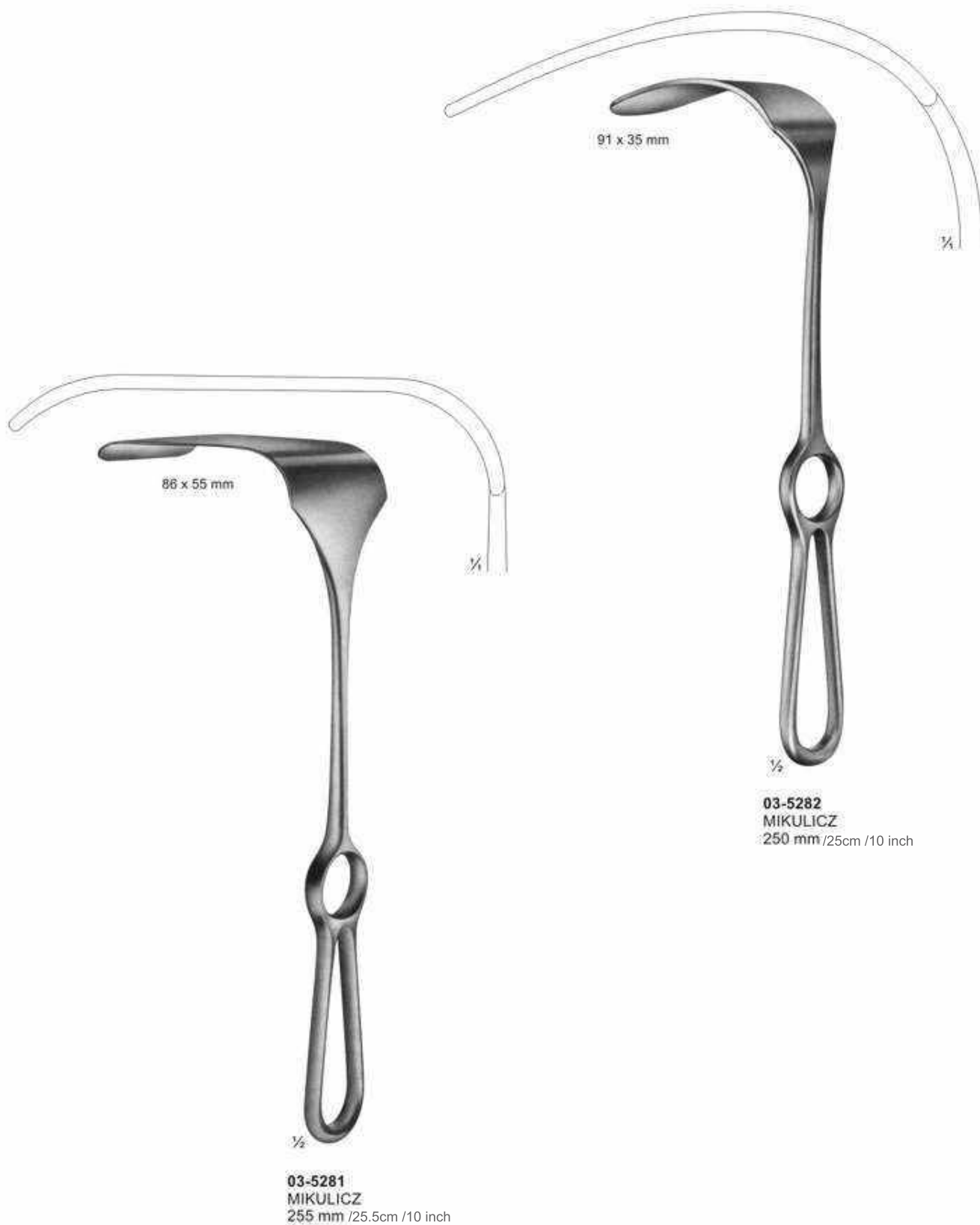

Retractors For Deep Surgery (Abdominal Retractors)

03-5285 150 x 39 mm
03-5286 150 x 57 mm

03-5283 121 x 50 mm
03-5284 147 x 50 mm

03-5285 - 03-5286
KELLY
03-5285 150 x 39 mm
03-5286 150 x 57 mm
 260 mm / 26cm / 10 inch

03-5283 - 03-5284
MIKULICZ
03-5283 121 x 50 mm
03-5284 147 x 50 mm
Liver Retractor
 250 mm / 25cm / 10 inch

Retractors, Abdominal Retractors



Length of Blades	Width of Blades		
	35mm	45mm	60mm
62mm	03-5287	03-5290	03-5294
92mm	03-5288	03-5291	03-5295
122mm	03-5289	03-5292	03-5296
160mm		03-5293	03-5297

Abdominal Retractors



03-5304 - 03-5308
ROCHARD
 310 mm
03-5304 48 x 90 mm
03-5305 48 x 105 mm
03-5306 48 x 120 mm
03-5307 48 x 135 mm
03-5308 48 x 155 mm



03-5309
ROCHARD
 Fixation device for



03-5310 - 03-5313
DOYEN
 280 mm / 28cm / 11 inch
03-5310 48 x 90 mm
03-5311 48 x 105 mm
03-5312 48 x 120 mm
03-5313 48 x 135 mm



03-5314
DOYEN-CHILD
 Fixation device
 220 mm / 22cm / 9 inch



03-5315
 Chain
 with weight
 645g
 790 mm / 79cm / 31 inch

Pelvis Retractors

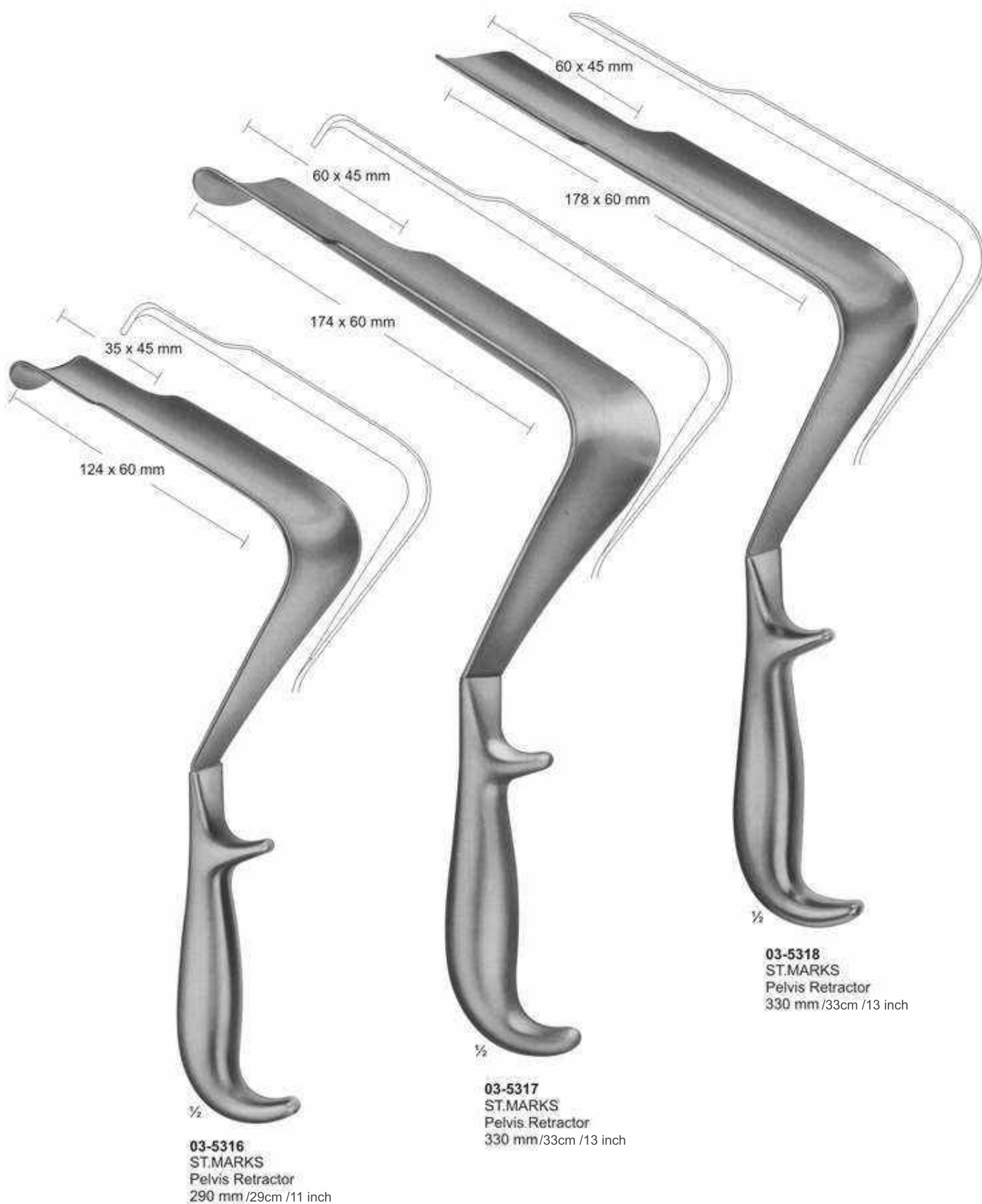

Abdominal- and Intestinal Spatulas

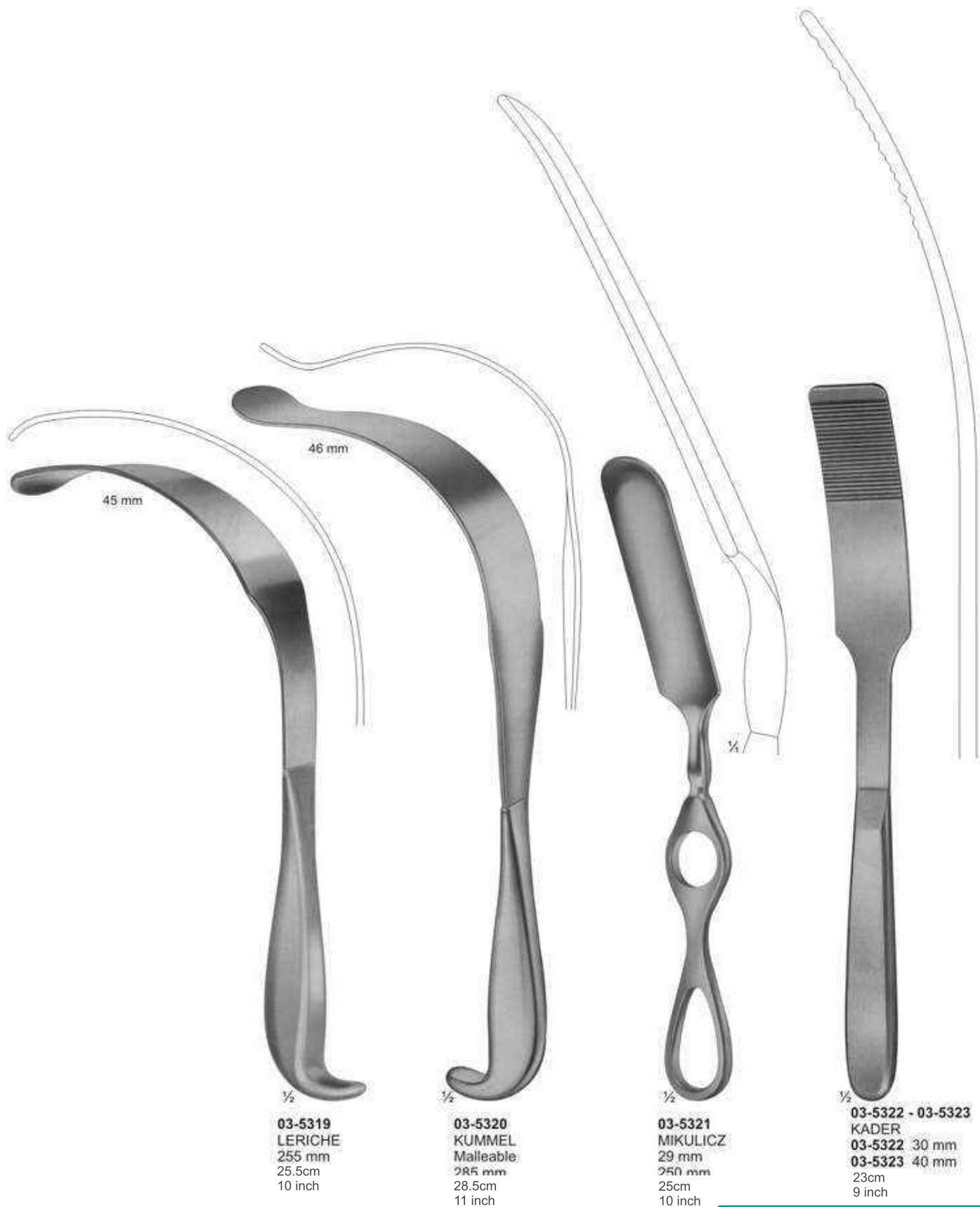

Abdominal- and Intestinal Spatulas



03-5324
REVERDIN
 285 mm /28.5cm /11 inch



03-5325
HABERER
 Malleable
 305 mm/30.5cm /12 inch



03-5326 - 03-5328
03-5326 30 mm
03-5327 40 mm
03-5328 50 mm
 Malleable
 330 mm /33cm /13 inch



03-5329
TUFFIER
 Malleable
 200 mm /20cm /8 inch

Self-Retaining Retractors



03-5330
BOSE
60 mm



03-5331
FINSEN
50 mm



03-5332
FINSEN
70 mm



03-5333
FINSEN modif.
75 mm



03-5334
45 mm
4.5cm



03-5335
55 mm
5.5cm



03-5336
MUELLER
65 mm
6.5cm



03-5337
100 mm
10cm
4 Inch



03-5338



03-5339



03-5338 - 03-5339
03-5338 70 mm
03-5339 100 mm

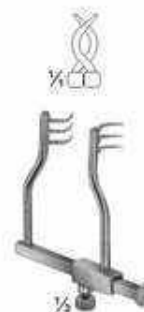

03-5340
LOGAN
modif. REILL
50 mm /5cm



03-5341
JANSEN
100 mm /10cm /4 inch



03-5342
JANSEN
100 mm /10cm /4 inch

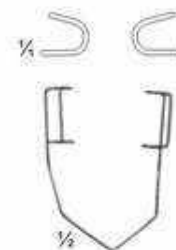

03-5343
BARRAQUER
45 mm /4.5cm

Self-Retaining Retractors



03-5344
WEITLANER
 Sharp
 110 mm / 11cm / 4 inch



03-5345
WEITLANER
 Semi-Sharp
 110 mm / 11cm / 4 inch



03-5346
WEITLANER
 Blunt
 110 mm / 11cm / 4 inch



03-5347
WEITLANER
 Sharp
 130 mm / 13cm / 5 inch



03-5348
WEITLANER
 Semi-Sharp
 130 mm / 13cm / 5 inch



03-5349
WEITLANER
 Blunt
 130 mm / 13cm / 5 inch

Self-Retaining Retractors

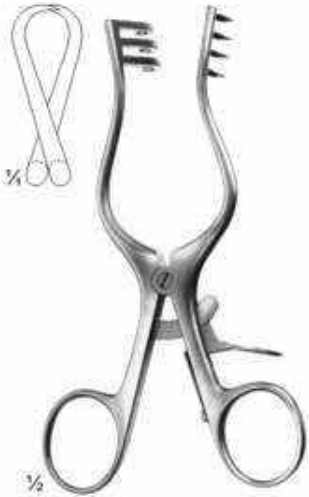

03-5350
WEITLANER
 Sharp
 130 mm / 13cm / 5 inch

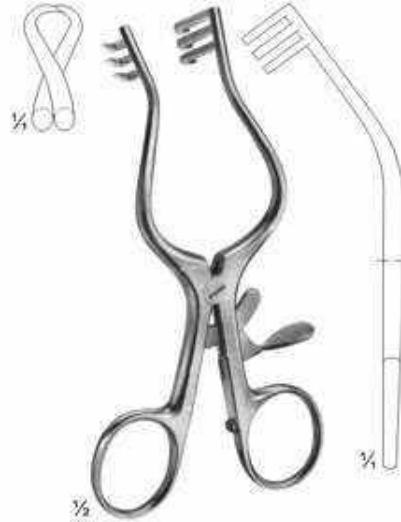

03-5351
WULLSTEIN
 Sharp
 130 mm / 13cm / 5 inch

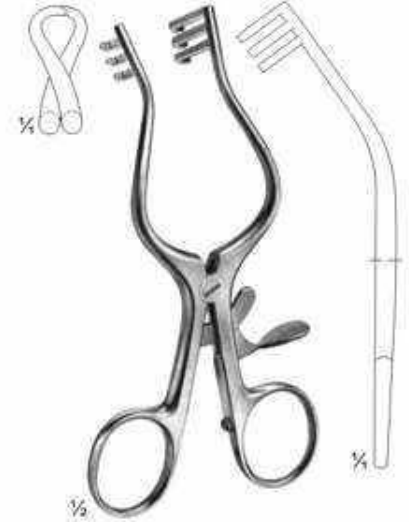

03-5352
WULLSTEIN
 Blunt
 130 mm / 13cm / 5 inch



03-5353
WEITLANER
 Sharp
 165 mm / 16.5cm / 6 inch



03-5354
PLESTER
 Blunt
 110 mm / 11cm / 4 inch



03-5355
PERKINS
 130 mm / 13cm / 5 inch

Self-Retaining Retractors

/11cm /4 inch



03-5356
ADSON-BABY
 Blunt
 140 mm /14cm /6 inch

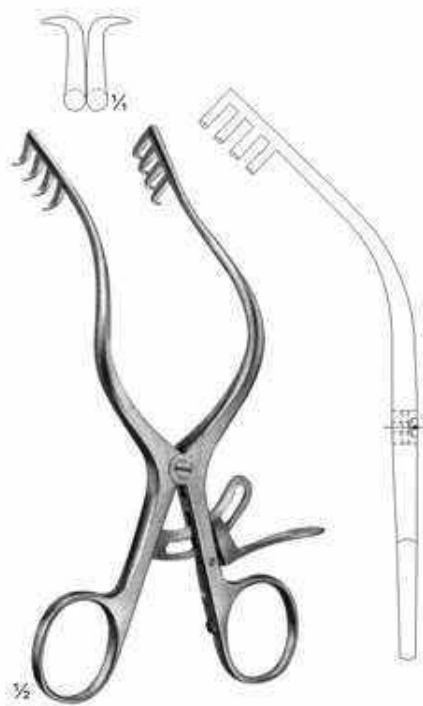

03-5357
MOLLISON
 Sharp
 155 mm /15.5cm /6 inch



03-5358
MAYO-ADAMS
 165 mm /16.5cm /6 inch

Self-Retaining Laminectomy Retractors

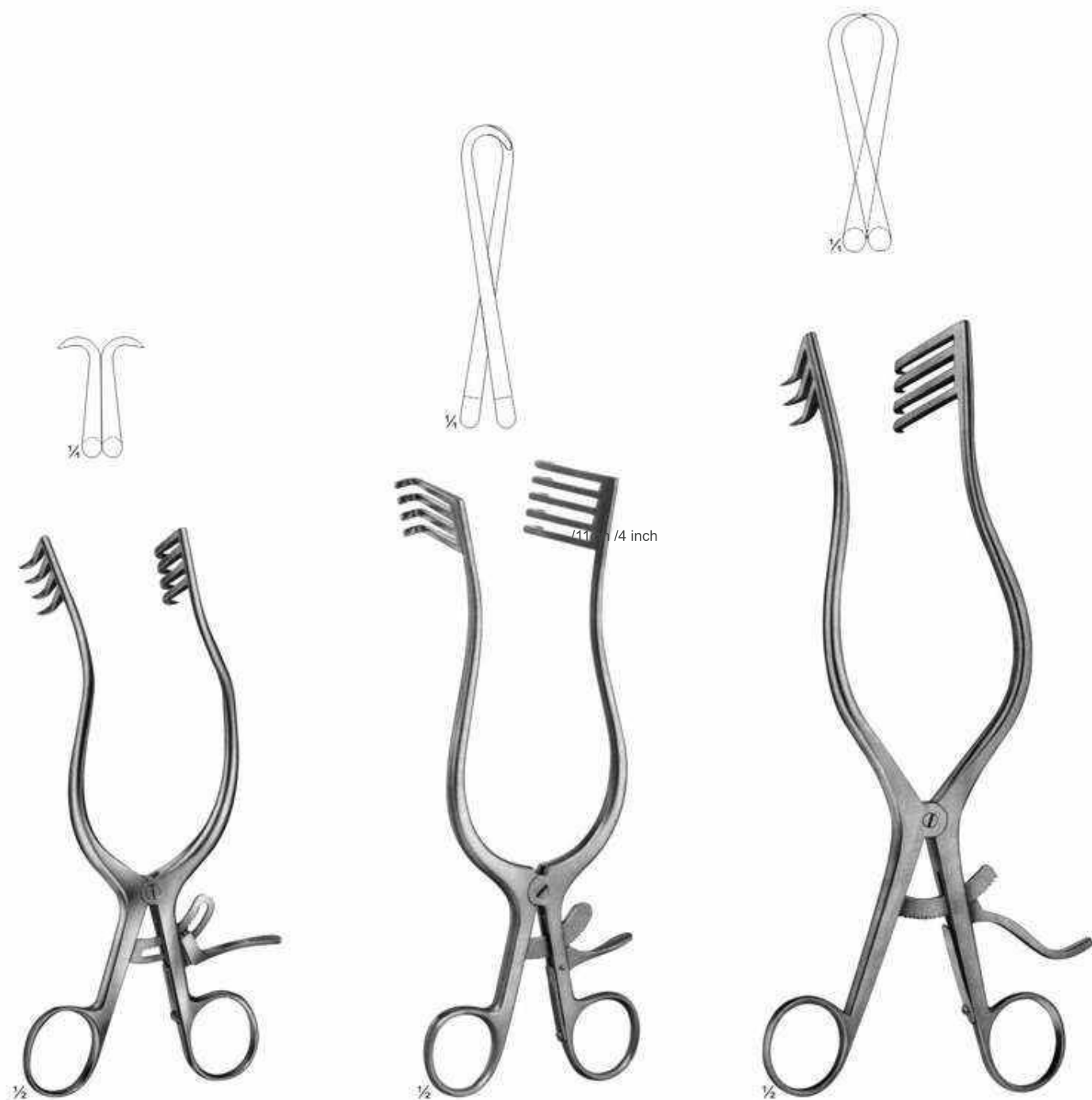

03-5359
ANDERSON-ADSON
 Sharp
 190 mm / 19cm / 7 inch

03-5360
NORFOLK and
NORWICH
 Blunt
 220 mm / 22cm / 9 inch

03-5361
ADSON
 Sharp
 265 mm / 26.5cm / 10 inch

Self-Retaining Laminectomy Retractors

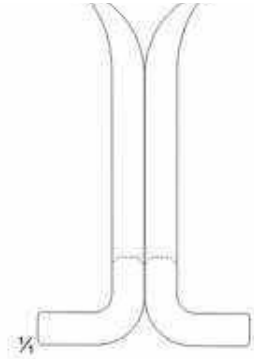

03-5362 - 03-5363
BECKMANN-ADSON
 Sharp
 310 mm / 31cm / 12 inch



03-5363
BECKMANN-ADSON
 Semi-Sharp
 310 mm
 31cm
 12 inch



03-5364
ADSON
 Semi-Sharp
 320 mm / 32cm / 12 inch



03-5365
BECKMANN-EATON
 Sharp
 320 mm / 32cm / 12 inch

Special Retractors



03-5366
JOLL (FRIEDMAN)
Thyroid- and Vaginal Retractor
155 mm /15.5cm /6 inch



03-5367
JACKSON BURROWS
Retractor, blunt
185 mm/18.5cm /7 inch



03-5368
GELPI
Vaginal Retractor
135 mm /13.5cm /5 inch



03-5369
GELPI
Skin- and Vaginal Retractor
175 mm /17.5cm /7 inch



03-5370
DE BAKEY
Femur Retractor
145 mm/14.5cm /6 inch

Self Retaining Retractors for Laminectomy and other Operations

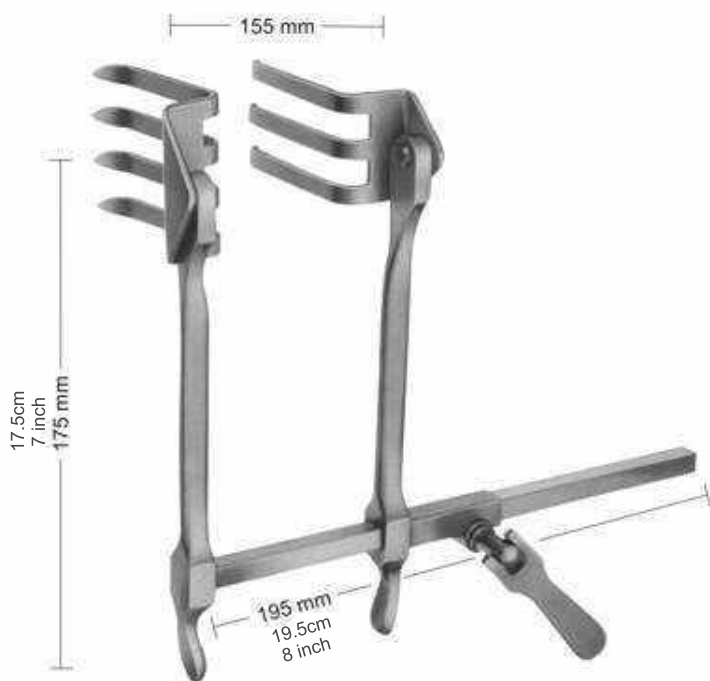

03-5371
SCOVILLE-RICHTER
 Retractor with 1 pair blades reversible type.
 The Retractor bar and shanks may be easily rotated 180° when blades are in situ.



03-5372
 62 x 52 mm: 62 x 37 mm
 PR= Pair



03-5373
 47 x 51 mm



03-5374
 30 x 40 mm



03-5375
 37 x 62 mm

Retractors for Cervical Spine



03-5376
 CLOWARD modif.
 Spreader Only
 Consisting of:
 Spreader Only
03-5377 1 Blade
03-5378 1 Blade
03-5379 1 Blade
03-5380 1 Blade
03-5381 1 Blade



03-5377



03-5378



03-5382



03-5383



03-5379



03-5380



03-5384



03-5385



03-5381



03-5386

Blades only used for **03-5376**

Retractors for Cervical Spine



03-5376
 CLOWARD modif.
 Spreader Only
 Consisting of:
 Spreader Only
03-5377 1 Blade
03-5378 1 Blade
03-5379 1 Blade
03-5380 1 Blade
03-5381 1 Blade



03-5377



03-5378



03-5382



03-5383



03-5379



03-5380



03-5384



03-5385



03-5381



03-5386

Blades only used for **03-5376**

Lamina Spreaders



03-5416
CLOWARD
155 mm
15.5cm
6 inch



03-5417
CLOWARD
135 mm
13.5cm
5 inch



03-5418
INGE
170 mm
17cm
7 inch

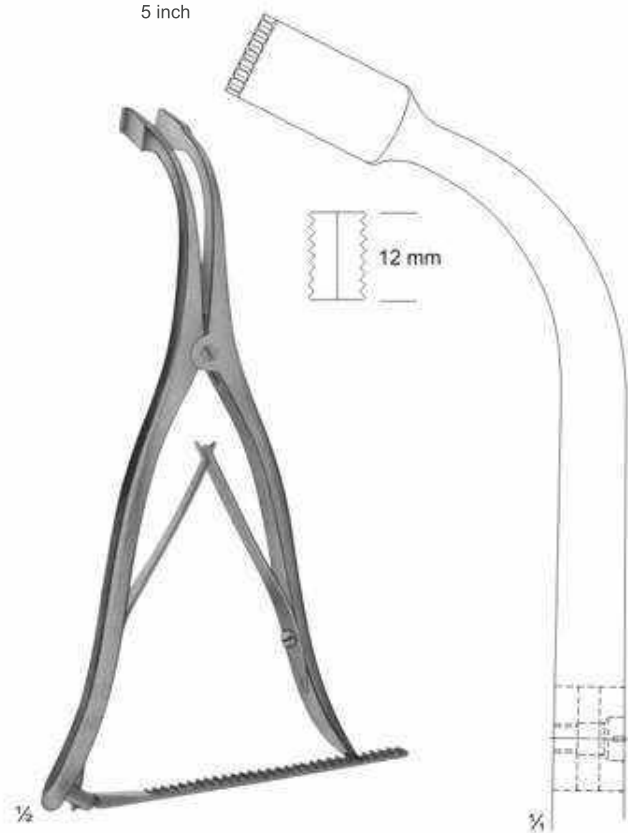

03-5419
INGE
275 mm/27.5cm /11 inch

Abdominal Retractors

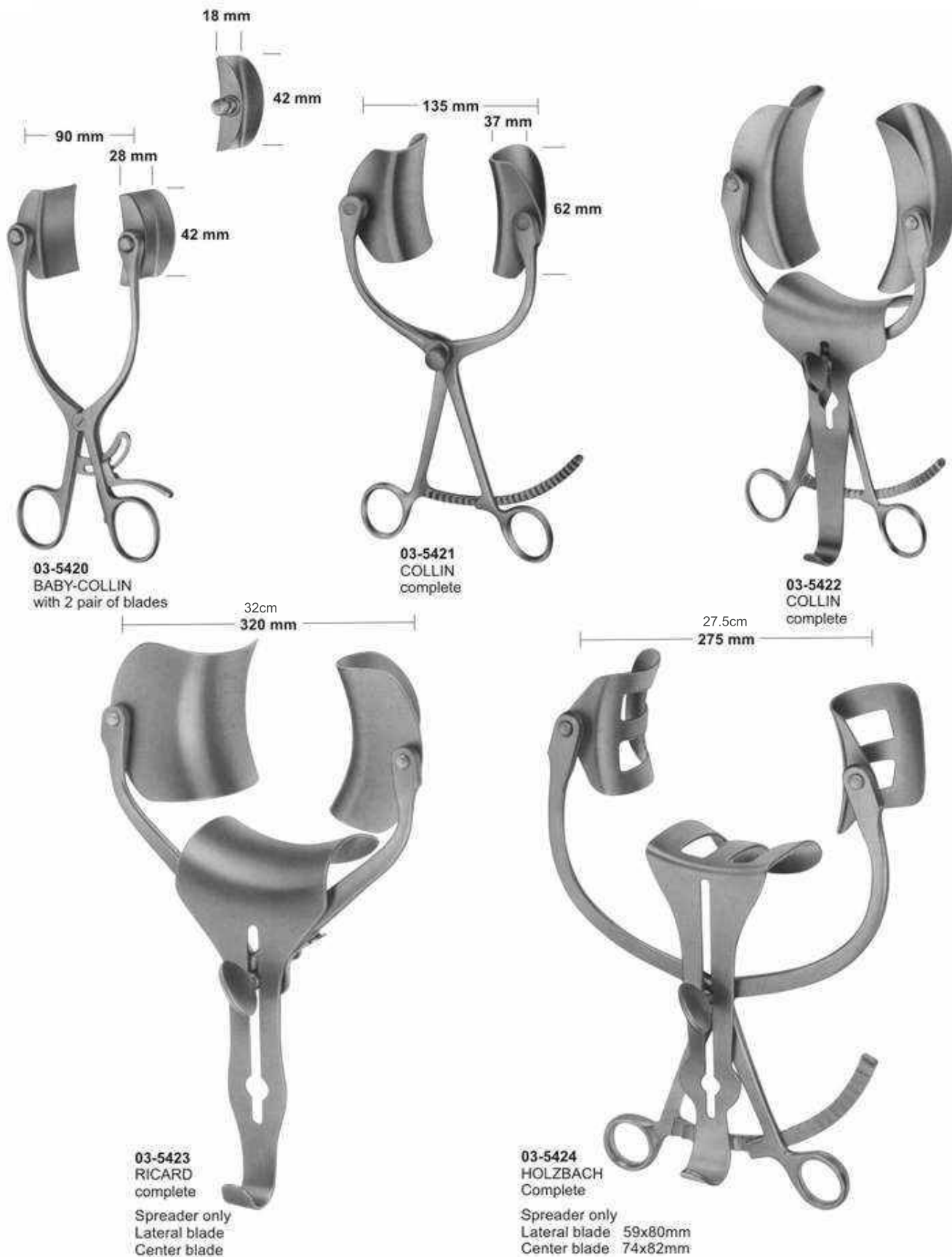

Abdominal Baldes



Lateral blades only
 03-5425 37x62 mm
 03-5426 37x80 mm
 03-5427 37x98 mm



03-5428 61x80 mm

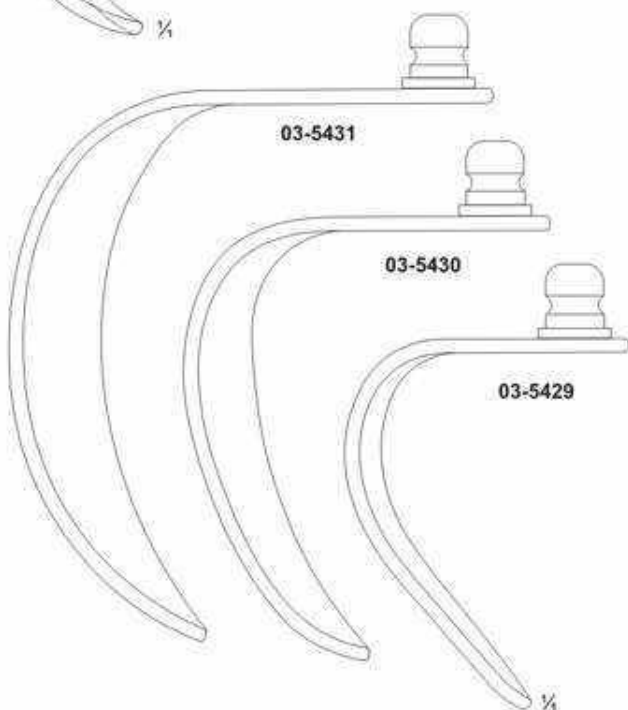

03-5429 48x59 mm
 03-5430 58x80 mm
 03-5431 72x84 mm



Abdominal Retractors

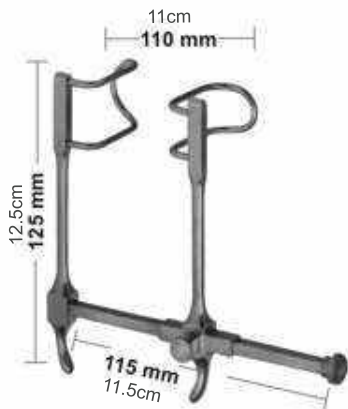

03-5433
GOSSET
 Blades: 38 mm deep

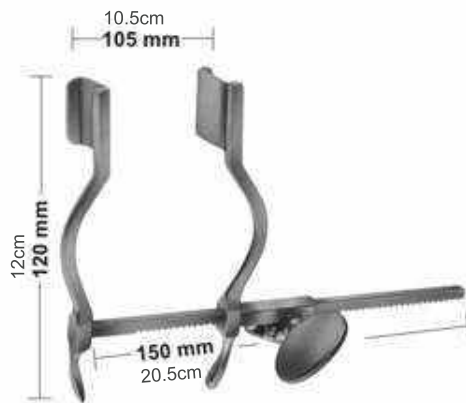

03-5434
HERTZLER
 Blades 20 X 25 mm

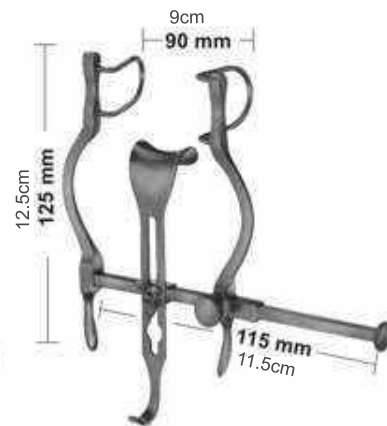

03-5435
BALFOUR-BABY
 Lateral blades 27 mm deep
 (03-5435) Center blade 21x24 mm



03-5436
GOSSET
 Blades: 55mm deep

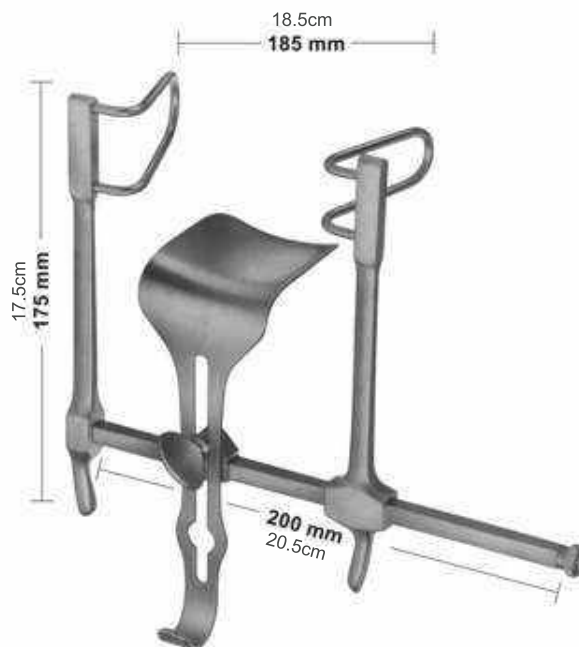

03-5437
GOSSET
 Lateral blades 58 mm deep
 Center blade
 59 x 57 mm

Abdominal Retractors

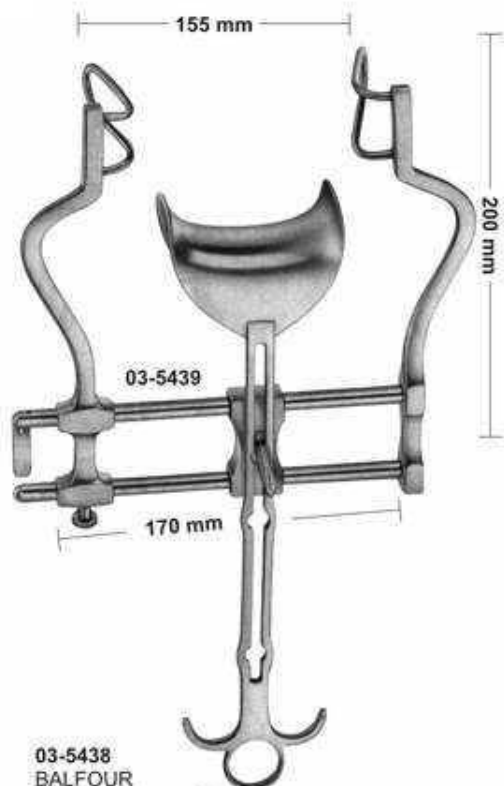

03-5438
BALFOUR
Lateral blades: 60 mm deep
(03-5439) Center blade
47 x 80 mm

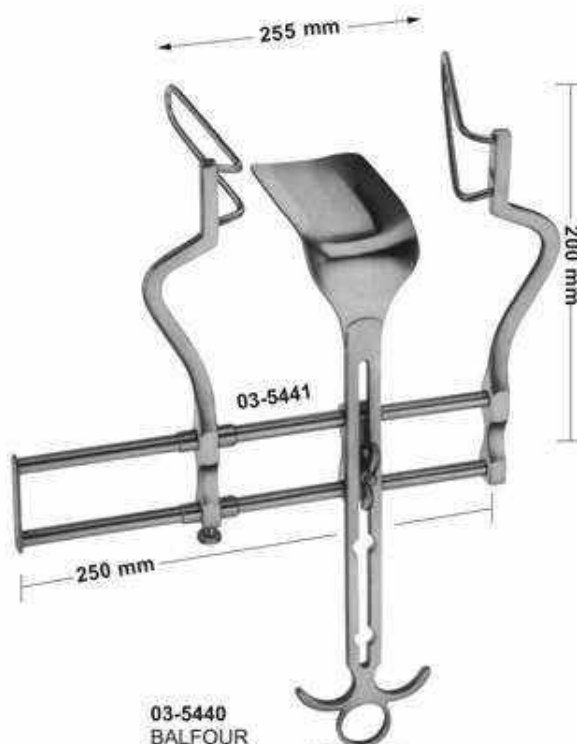

03-5440
BALFOUR
Lateral blades: 105 mm deep
(03-5441) Center blade
107x59 mm



03-5442
Center blade only
54x80 mm

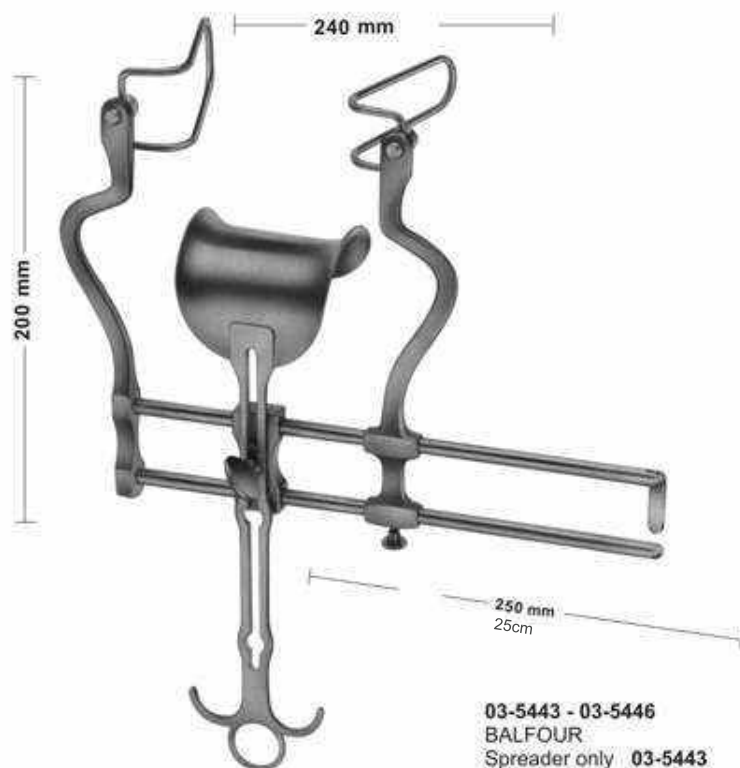

03-5443 - 03-5446
BALFOUR
Spreader only **03-5443** **03-5444** **03-5445** **03-5446**
Lateral blades: 50 mm 60 mm 75 mm 90 mm
Center blade: 47 x 80 mm 62x76 mm 80x80 mm 80x80 mm



Sales Unit of blades: PR = pair

Lateral blades:
03-5447
50 mm deep
03-5448
60 mm deep
03-5449
75 mm deep
03-5450
90 mm deep

Abdominal Retractors

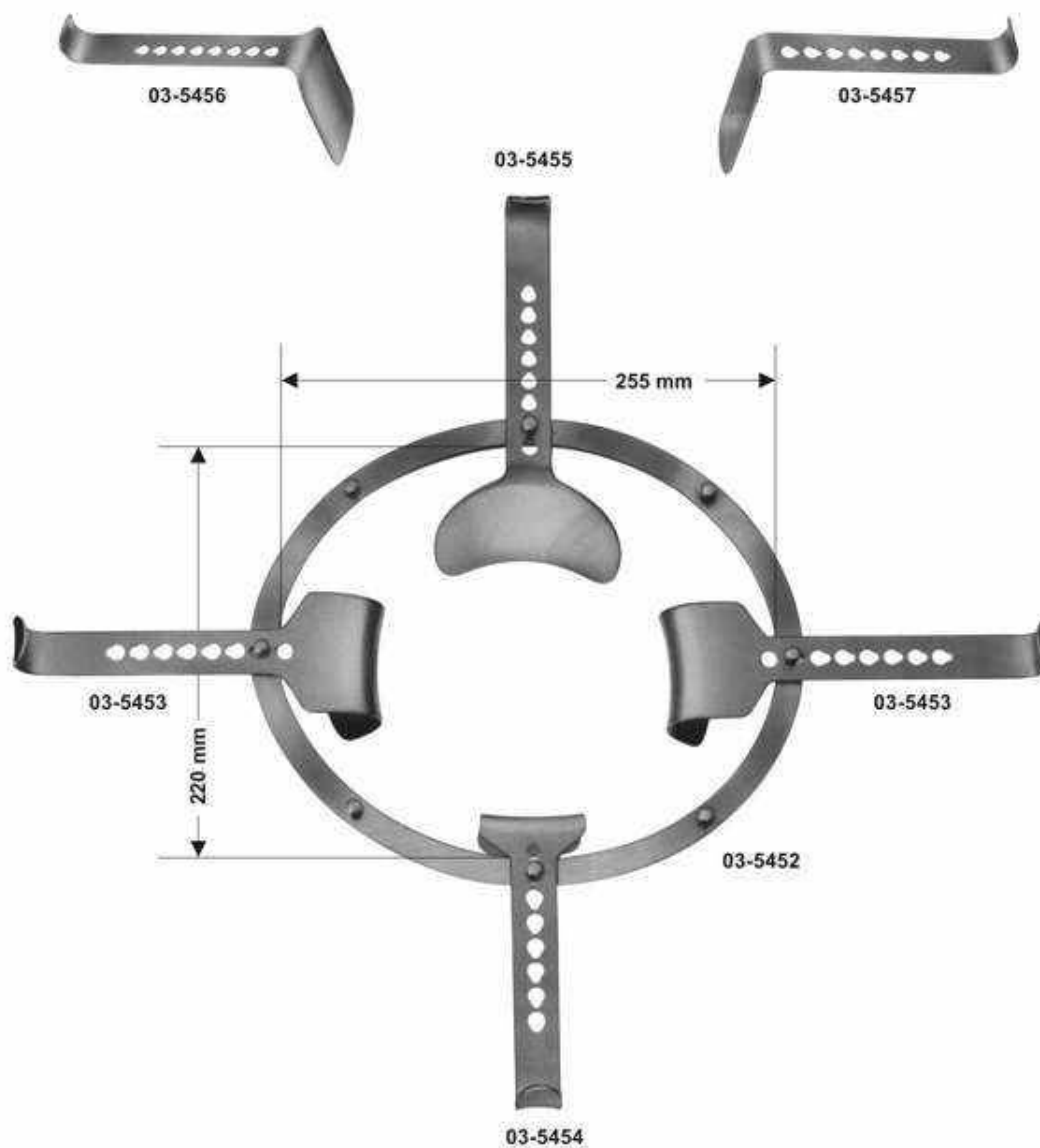

03-5451

SEMM

consisting of:

03-5452 1 frame 225 x 220 mm

03-5453 2 blades 46 x 84 mm

03-5454 1 blade 53 x 54 mm

(for bladder)

03-5455 1 blade 82 x 97 mm

(for intestine)

03-5456 1 blade 98 x 51 mm

(for intestine)

03-5457 1 blade, narrow

107 x 36 mm

Abdominal Retractors

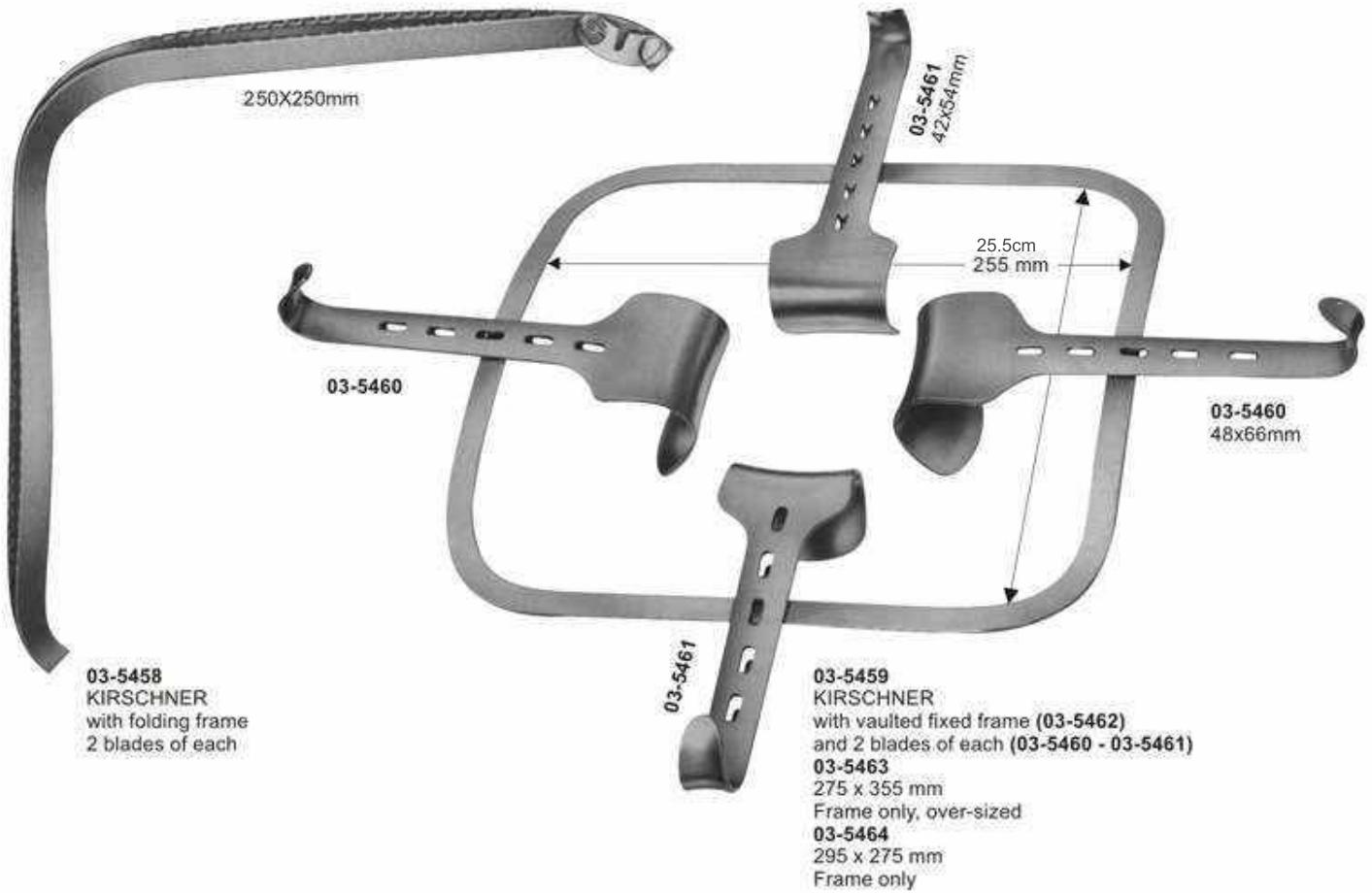

03-5465
KIRSCHNER
64 x 80 mm



03-5466
KIRSCHNER-BALFOUR
80x 82 mm



03-5467 - 03-5469
KIRSCHNER
03-5467 90x 69mm
03-5468 92x 95mm
03-5469 78x 58mm



03-5470 - 03-5472
KIRSCHNER
03-5470 108x42mm
03-5471 91x 55mm
03-5472 121x 55mm

Addition valves for corpulent persons.

Intestinal and Tissue Grasping Forceps

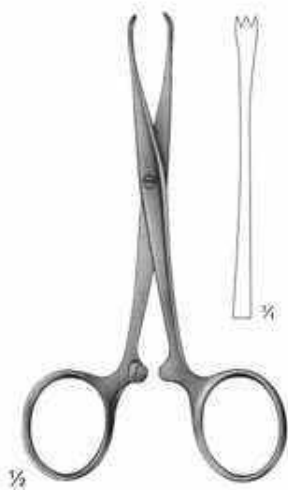

03-5473
CHAPUT
 2 X 3 teeth, sharp
 125 mm, /12.5cm /5 inch

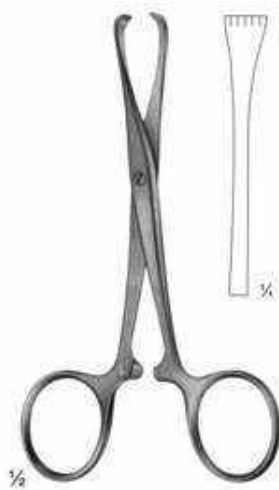

03-5474
TUFFIER
 5 X 6 teeth, sharp
 125 mm, /12.5cm /5 inch



03-5475
BOYS-ALLIS
 5 X 6 teeth, sharp
 155 mm, /15.5cm /6 inch



03-5476
BABY-ALLIS
 4 X 5 teeth
 130mm/13cm /5 inch

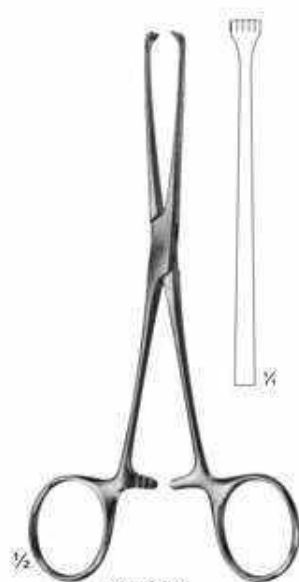

03-5477
ALLIS
 4 X 5 teeth
 155 mm, /15.5cm /6 inch

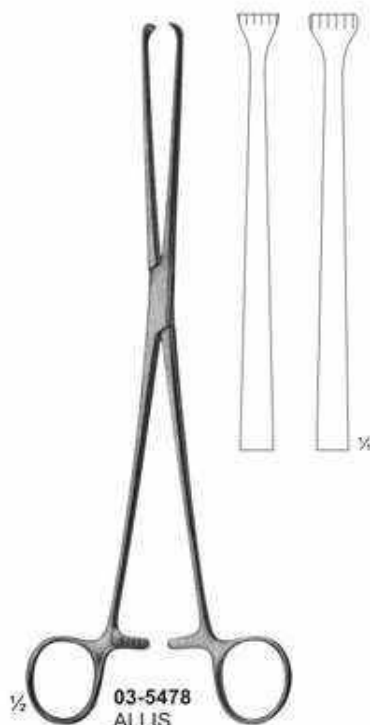

03-5478
ALLIS
 190 mm,
03-5479
 255 mm, /25.5cm /10 inch
 5 X 6 teeth
 Slender pattern



03-5480
JUDD-ALLIS
 3 X 4 teeth
 195 mm, /19.5cm /8 inch

Intestinal Grasping Forceps



03-5481
BABCOCK
155 mm
15.5cm
6 inch



03-5482 03-5483
170 mm 215 mm
17cm 21.5 cm

03-5482 - 03-5483
BABCOCK

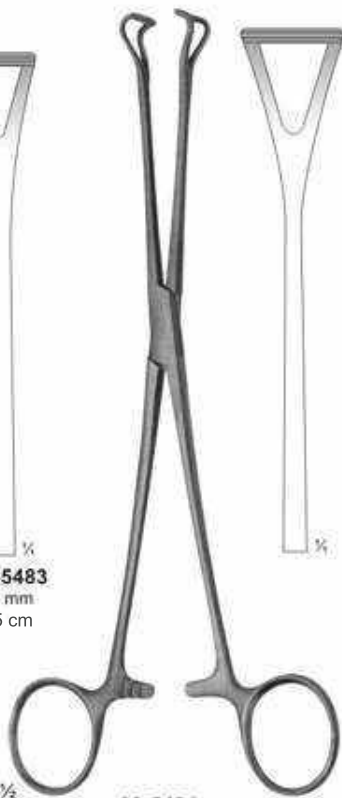

03-5484
BABCOCK
220 mm
22cm
9 inch



03-5485
COLLIN
140 mm, /22cm /9 inch

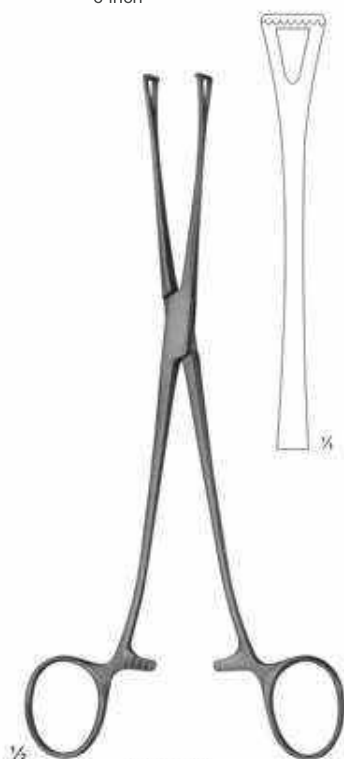

03-5486
LOCKWOOD
200 mm, /20cm /8 inch

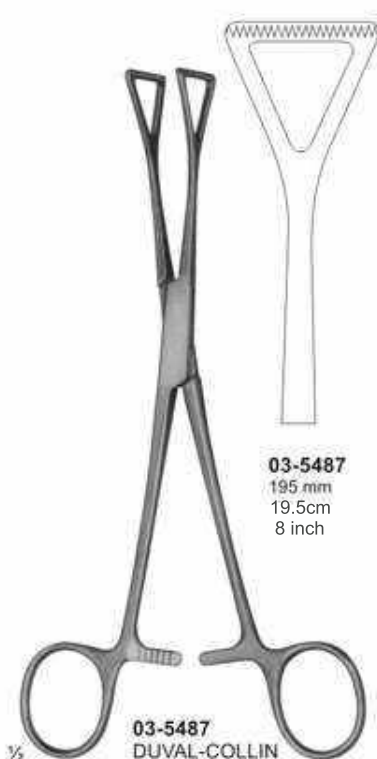

03-5487
DUVAL-COLLIN
195 mm
03-5488
200 mm /20cm /8 inch

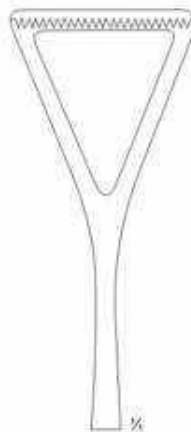

03-5488
200 mm
20cm
8 inch

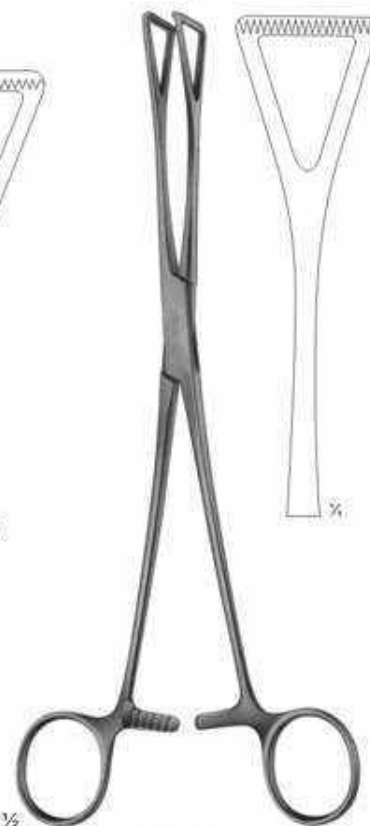

03-5489
DUVAL
230 mm, /23cm /9 inch

Organ - Tissue Grasping, Intestinal and Dissecting Forceps

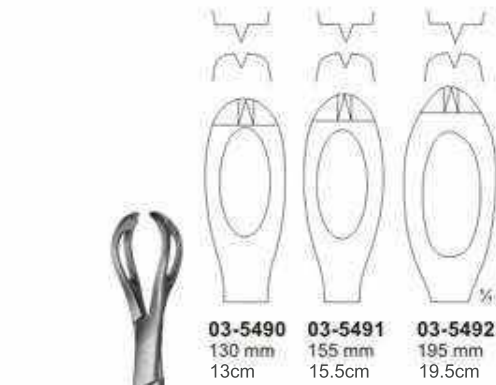

03-5490 130 mm / 13cm
03-5491 155 mm / 15.5cm
03-5492 195 mm / 19.5cm



03-5490 - 03-5492
LANE

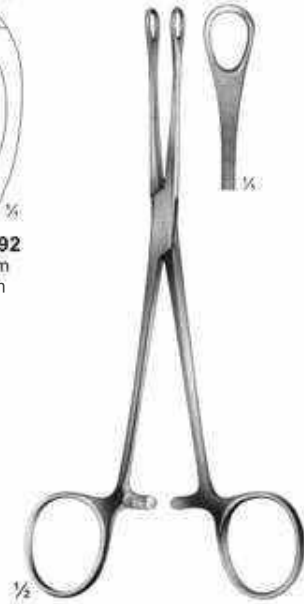

03-5493
WILLIAMS
160 mm / 16cm / 6 inch



03-5494
DENIS
BROWNE
190 mm / 19cm / 7 inch



03-5495
DUVAL
140 mm
14cm
6 inch



03-5496 03-5497
DUROGRIP

03-5496 - 03-5497
WANGENSTEEN
03-5496 150 mm / 15cm / 6 inch
03-5497 230 mm / 23cm / 9 inch

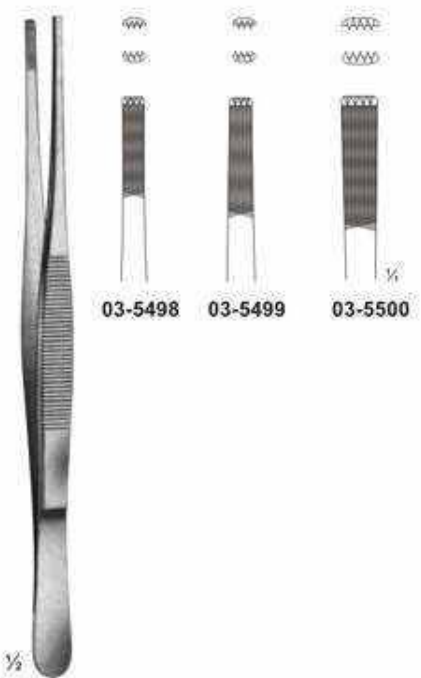

03-5498 - 03-5500
STILLE-BARRAYA
03-5498 180mm / 18cm / 7 inch
03-5499 200mm / 20cm / 8 inch
03-5500 250mm / 25cm / 9 inch

Organ - Tissue Grasping & Intestinal Forceps
ATRAUMATA



Ultra - Light - Forceps, Dissecting Forceps ATRAUMATA

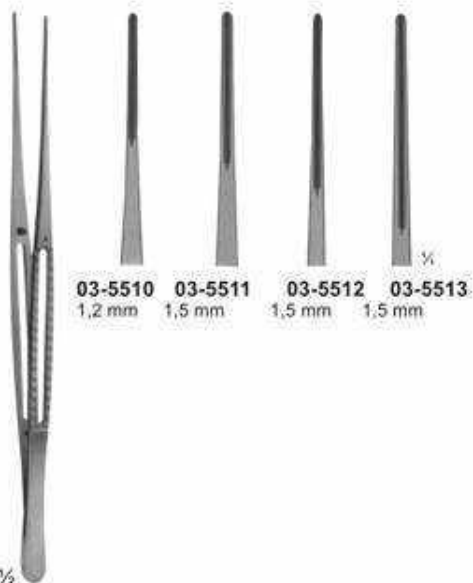

03-5510 1,2 mm
03-5511 1,5 mm
03-5512 1,5 mm
03-5513 1,5 mm

03-5510 - 03-5513
03-5510 150 mm
03-5511 200 mm
03-5512 240 mm
03-5513 300 mm

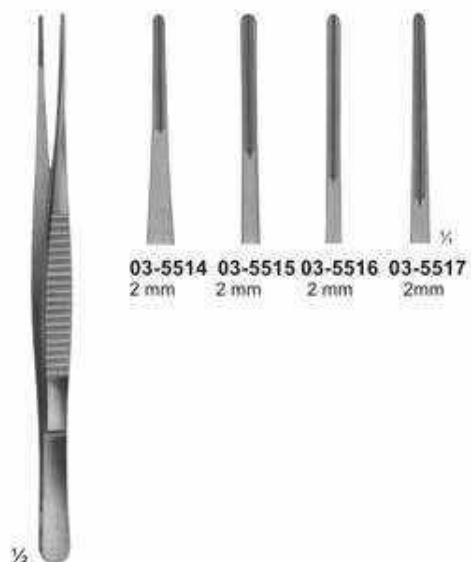

03-5514 2 mm
03-5515 2 mm
03-5516 2 mm
03-5517 2 mm

03-5514 - 03-5517
DE BAKEY
03-5514 150 mm /15cm /6 inch
03-5515 200 mm /20cm /8 inch
03-5516 240 mm /24cm /9 inch
03-5517 300 mm /30cm /12 inch

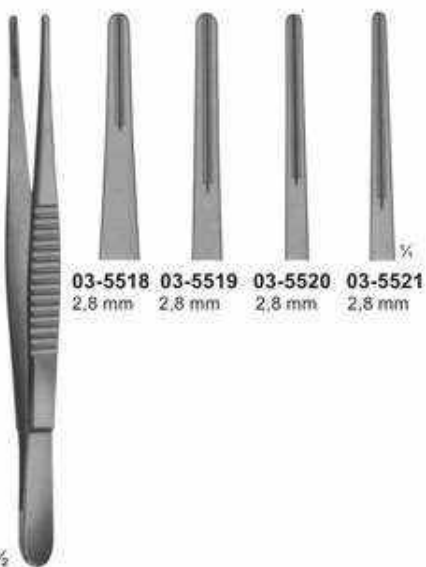

03-5518 2,8 mm
03-5519 2,8 mm
03-5520 2,8 mm
03-5521 2,8 mm

03-5518 - 03-5521
DE BAKEY
03-5518 150 mm /15cm /6 inch
03-5519 200 mm /20cm /8 inch
03-5520 240 mm /24cm /9 inch
03-5521 300 mm /30cm /12 inch



03-5522 3,3 mm
03-5523 3,5mm
03-5524 3,5mm

03-5522 - 03-5524
DE BAKEY
03-5522 200 mm /20cm /8 inch
03-5523 240 mm /24cm /9 inch
03-5524 300 mm /30cm /12 inch

Intestinal Clamps for Children

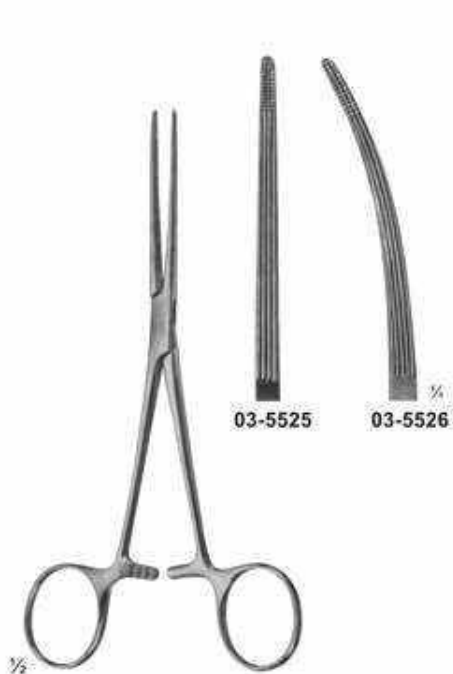

03-5525 - 03-5526
BAINBRIDGE
 155 mm / 15.5cm / 6 inch



03-5527
ALLEN
 155 mm / 15.5cm / 6 inch

Atraumata



03-5528 - 03-5529
BABY-KOCHER
 very elastic blades
 130 mm / 13cm / 5 inch

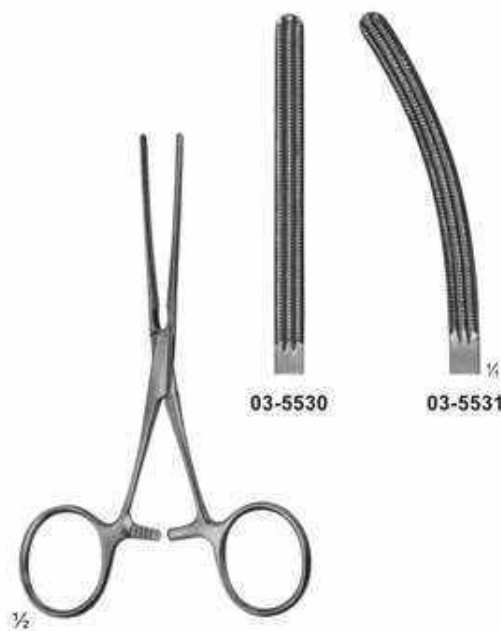

03-5530 - 03-5531
BABY-KOCHER
 with elastic blades
 130 mm / 13cm / 5 inch

Intestinal Clamps, Soft Elastic

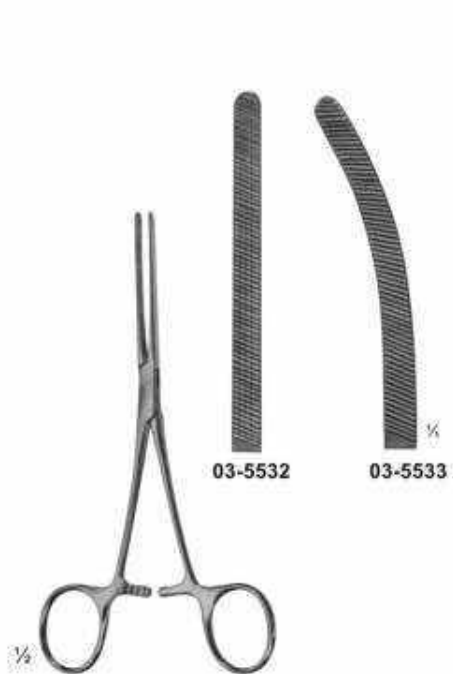

03-5532 - 03-5533
DOYEN
 elastic
 165 mm / 16.5cm / 6 inch



03-5534 - 03-5535
DOYEN
 with elastic blades
 170 mm / 17cm / 7 inch

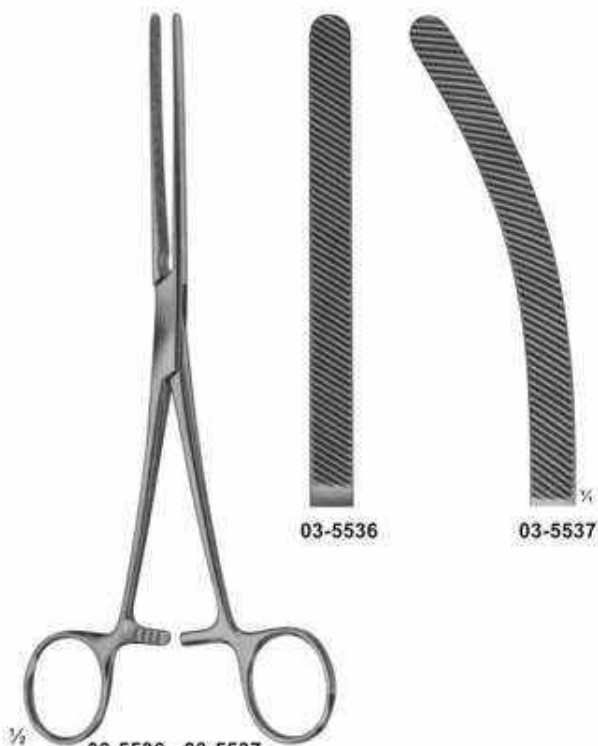

03-5536 - 03-5537
HARTMANN
 with elastic blades



03-5538 - 03-5539
HARTMANN
 with elastic blades

Intestinal Clamps, Soft elastic

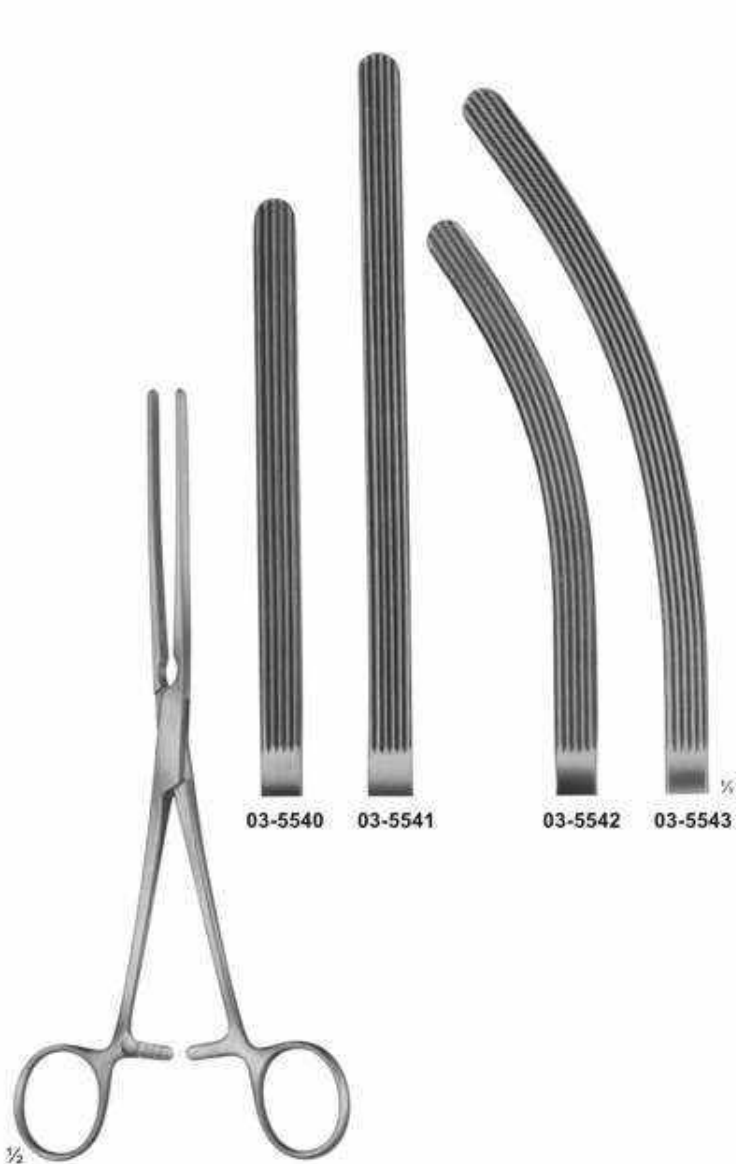

03-5540 - 03-5543
KOCHER
 with elastic blades
03-5540-03-5542 210 mm /21cm /8 inch
03-5541-03-5543 230 mm /23cm /9 inch

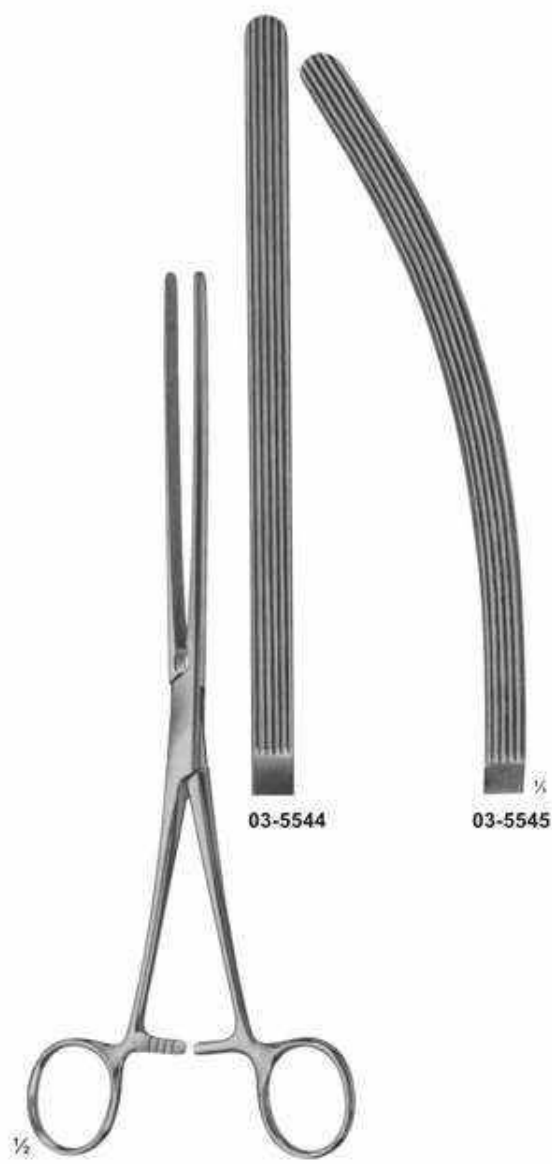

03-5544 - 03-5545
DOYEN
 with elastic blades
 240 mm /24cm /9 inch

Intestinal Clamps, Soft elastic



03-5546 - 03-5547
 DOYEN
 with elastic blades
 235 mm /23.5cm /9 inch

Atraumata

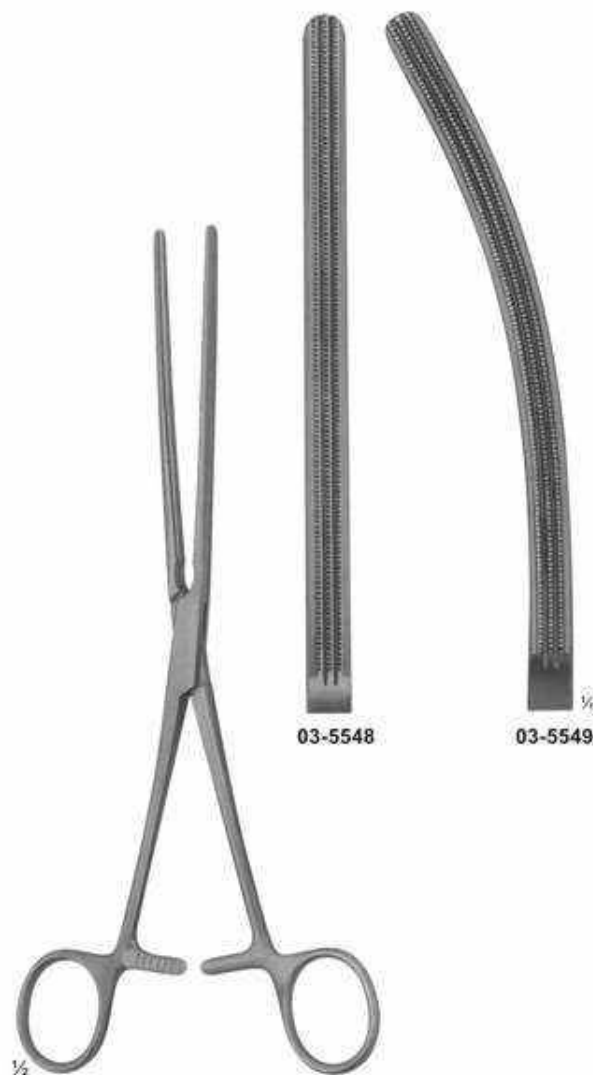

03-5548 - 03-5549
 DOYEN
 with elastic blades
 230 mm /23cm /9 inch

Intestinal Clamps, Soft elastic

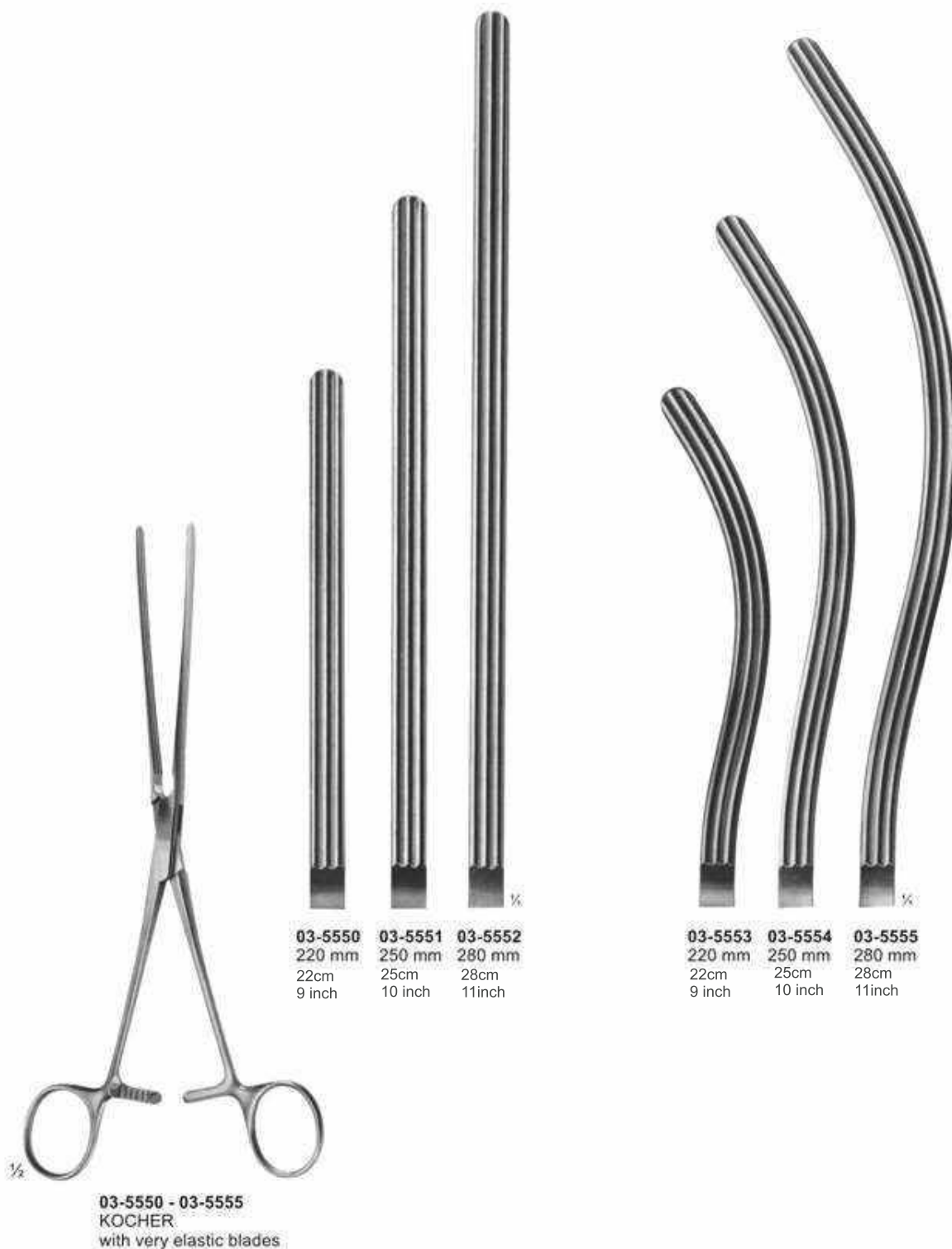

Intestinal Clamps, Soft elastic

Atraumata

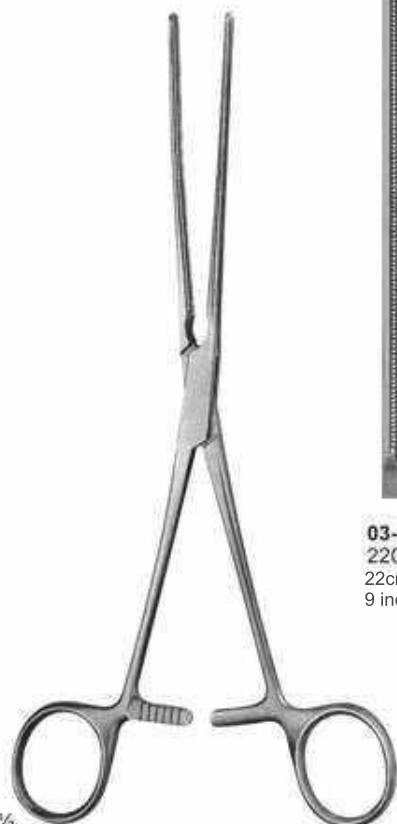

3/8

03-5556 - 03-5561
KOCHER
 with very elastic blades

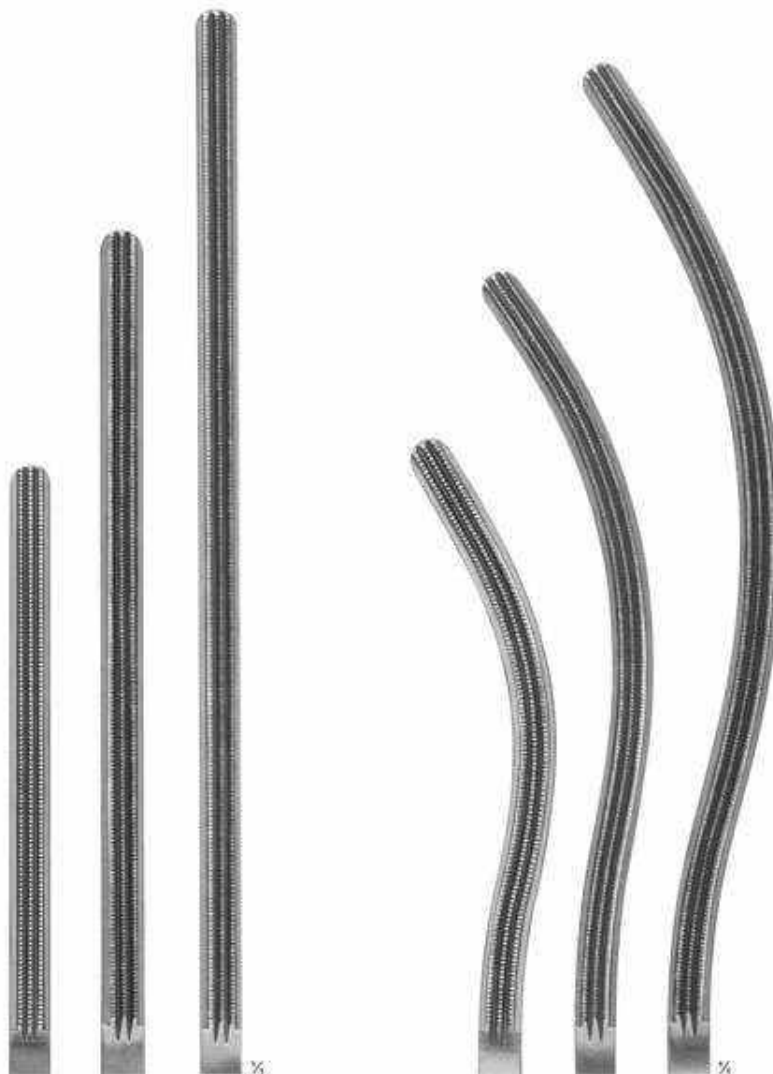

03-5556	03-5557	03-5558
220 mm	250 mm	280 mm
22cm	25cm	28cm
9 inch	10 inch	11inch

03-5559	03-5560	03-5561
220 mm	250 mm	280 mm
22cm	25cm	28cm
9 inch	10 inch	11inch

Intestinal Clamps



03-5562



03-5563

03-5562 - 03-5563
NUSSBAUM
 with elastic blades
 250 mm
 25cm
 10 inch



03-5564

03-5564
MOYNIHAN
 280 mm
 28cm
 11inch

Intestinal Clamps

Atraumata

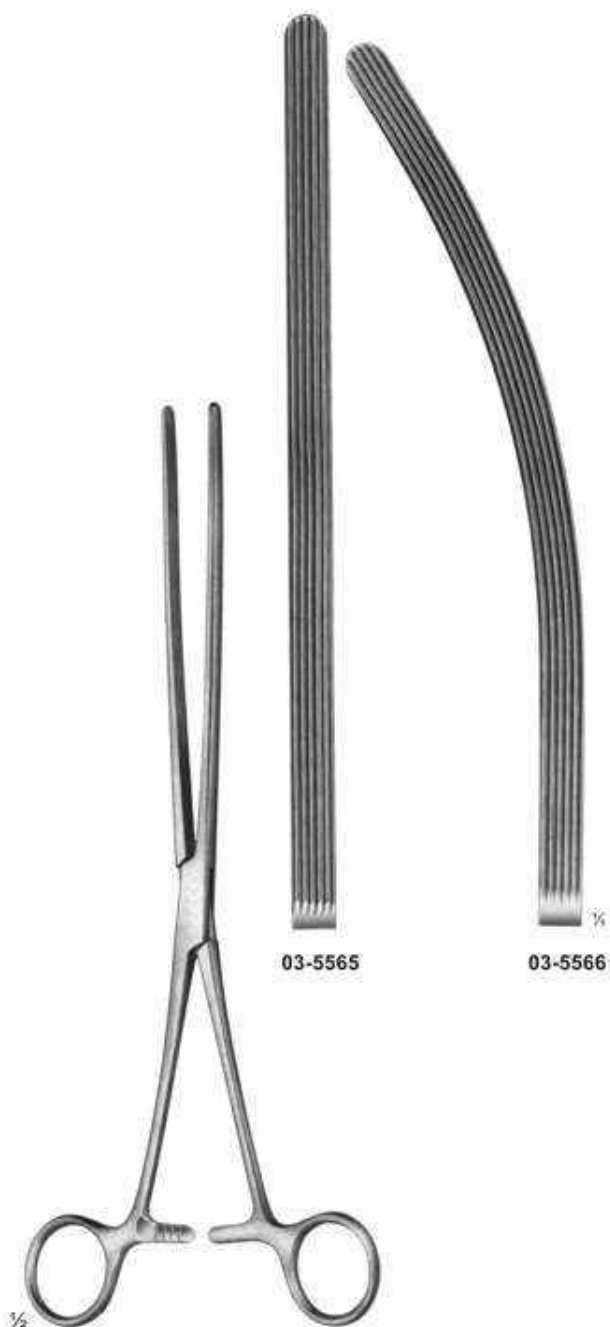

03-5565

03-5566

03-5567

03-5568

03-5565 - 03-5566
 MAYO-ROBSON
 hard elastic
 250 mm
 25cm
 10 inch

03-5567 - 03-5568
 MAYO-ROBSON
 250 mm
 25cm
 10 inch

Gastro-Intestinal Forceps, twin



03-5569
 LANE
 300 mm
 30cm
 12 inch

03-5570
 LANE
 300 mm
 30cm
 12 inch

Stomach Clamps

Atraumata

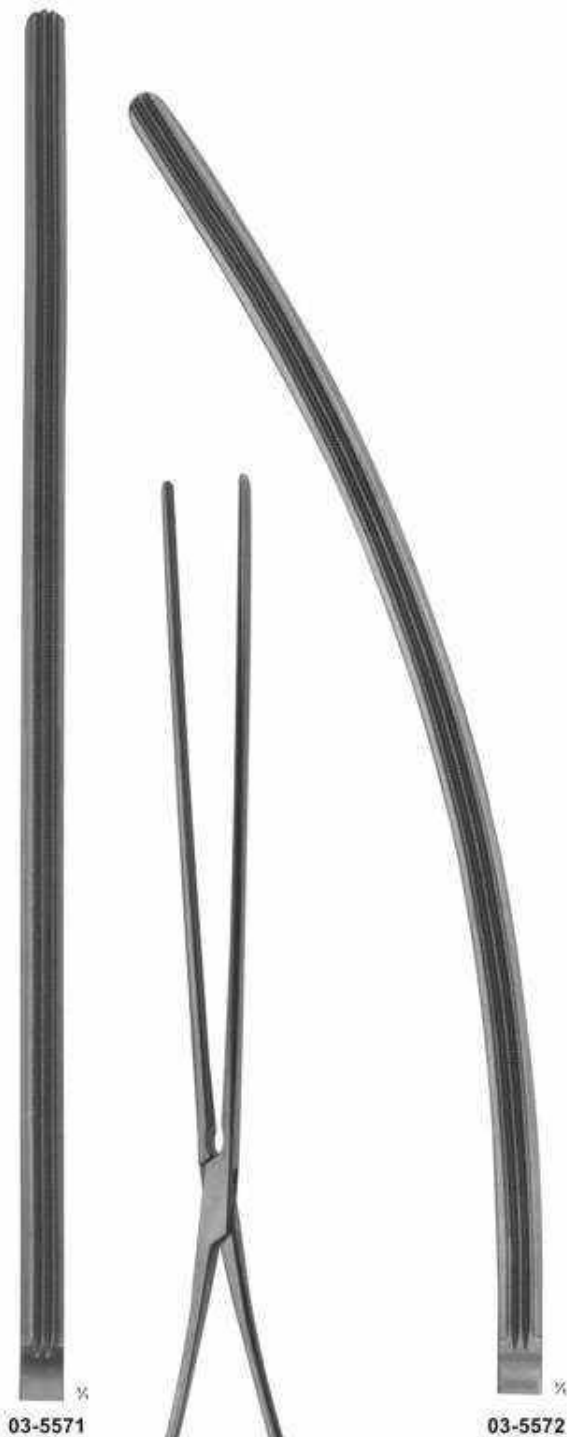

1/2
03-5571 - 03-5572
SCUDDER
 220 mm
 33cm
 13 inch



03-5573
KLEINSCHMIDT
 Spur crushers and
 Appendectomy clamps
 130 mm
 13cm
 5 inch

Intestinal and Pylorus Clamps



1/2
03-5574
 PAYR
 Intestinal clamp
 light pattern,
 for children
 180 mm
 18cm
 7 inch

1/2
03-5575
 PAYR
 200 mm
 20cm
 8 inch

1/2
03-5576
 PAYR
 275 mm
 27.5cm
 11 inch

1/2
03-5577
 PAYR
 Pylorus clamp
 315 mm
 31.5cm
 12 inch

Anastomosis Forceps

Atraumata

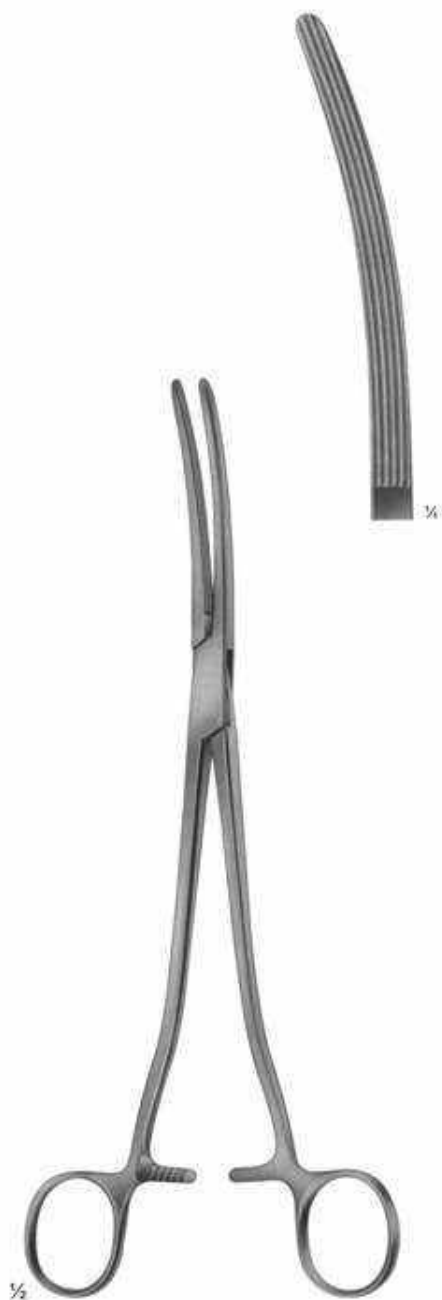

03-5578
PARKER-KERR
 anastomosis forceps
 for colon resection
 250 mm / 25cm / 10 inch



03-5579	03-5580	03-5581
255 mm	265 mm	275 mm
25.5cm	26.5cm	27.5cm

03-5579 - 03-5581
DICK
 pressure clamps

Sigmoid Anastomosis Forceps



Atraumata Sigmoid Anastomosis Forceps

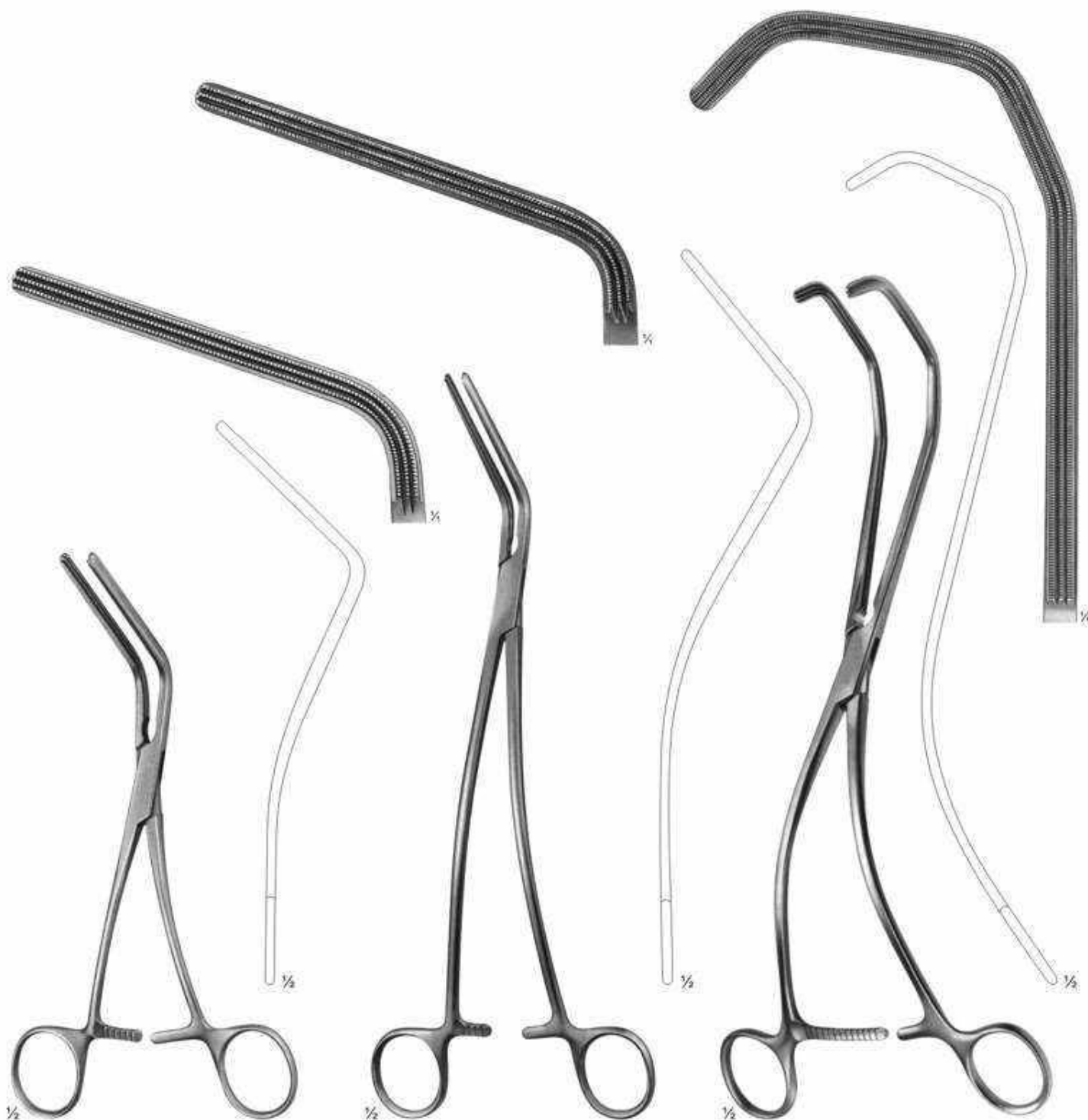

03-5585
MORRIS
 175 mm
 7 inch

03-5586
DE BAKAY
(MORRIS modif.)
 240 mm
 9 inch

03-5587
KERSTING
 270 mm
 11 inch

Rectal Specula



03-5588
KILLIAN
 for children
 145 mm
 14.5cm
 6 inch



03-5589
SIMS
 160 mm
 16cm
 6 inch



03-5590
SIMS
 160 mm
 16cm
 6 inch

Rectal Specula

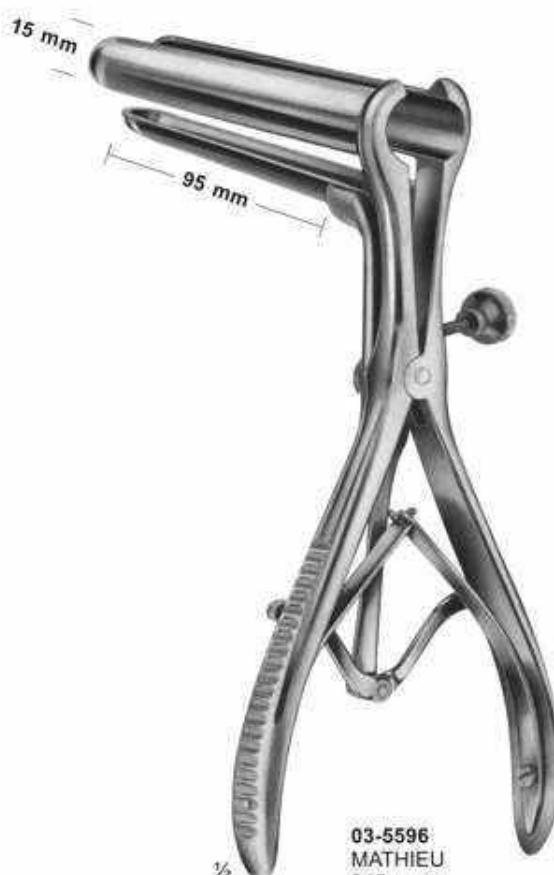
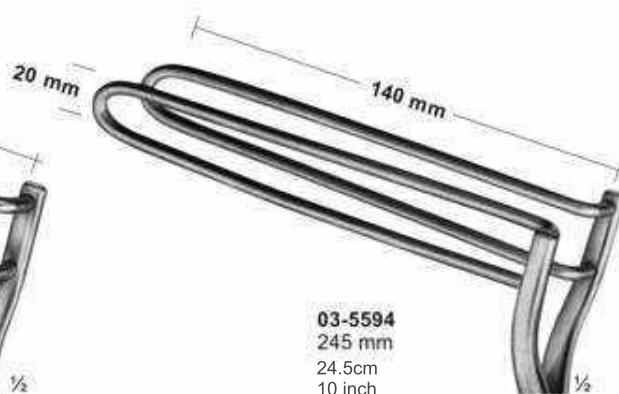
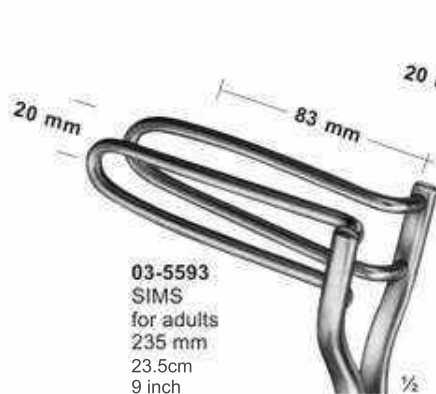

Anuscopy-Sphincteroscopes, Proctoscopes



03-5597
IVES-FANSLER
Anuscopy
145 mm / 14.5cm / 6 inch
∅ 24mm



03-5598
KELLY
Sphincteroscope
160 mm / 16cm / 6 inch
∅ 21mm

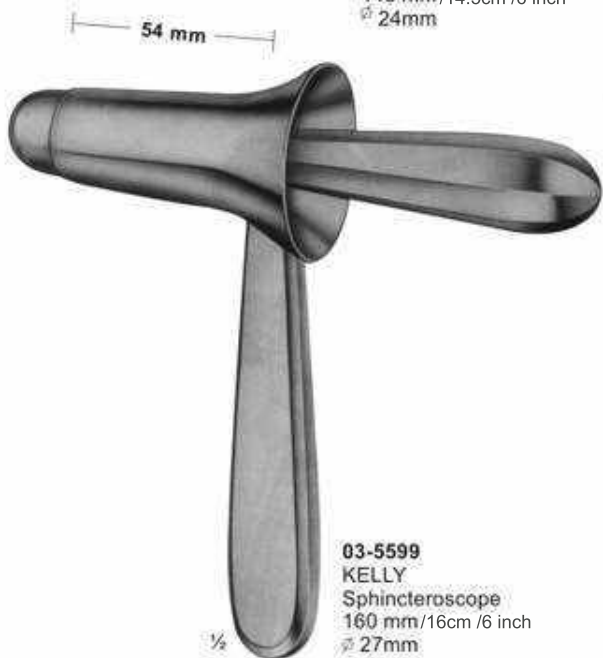

03-5599
KELLY
Sphincteroscope
160 mm / 16cm / 6 inch
∅ 27mm

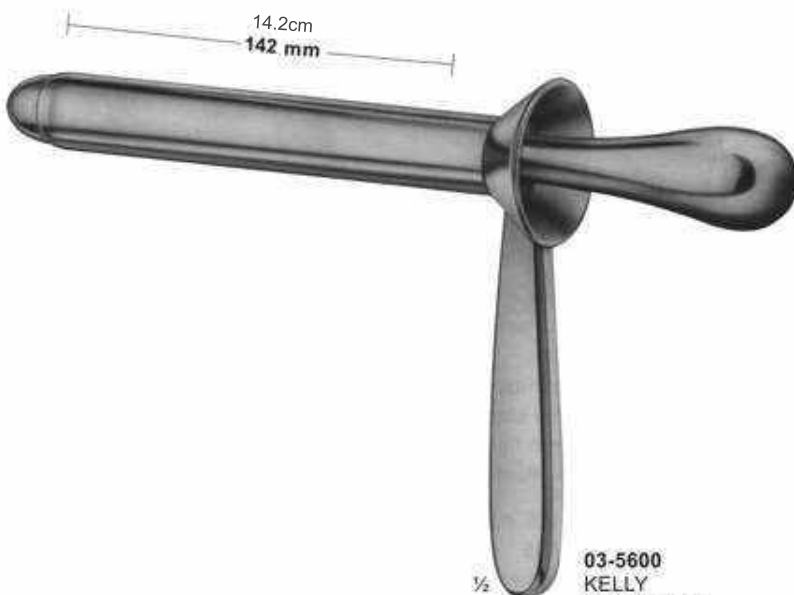

03-5600
KELLY
Proctoscope
140 mm / 14cm / 6 inch
∅ 22mm

Biopsy forceps for rectum

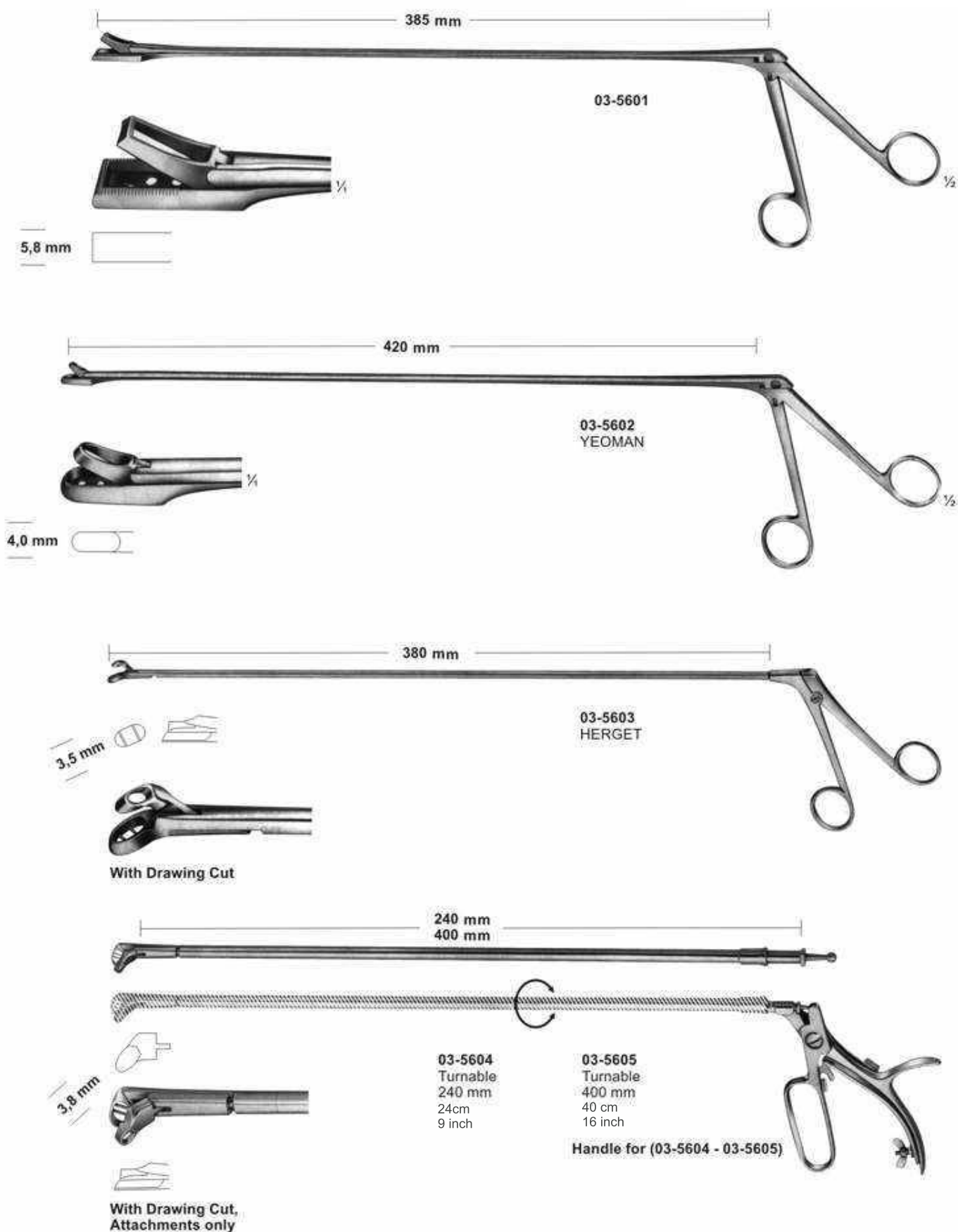

Biopsy Forceps & Swab Holders

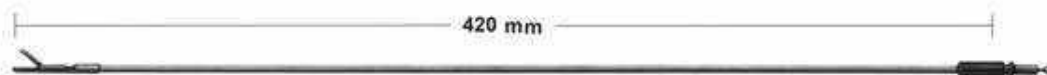

3.5 mm



3.5 mm



4.0 mm



4.0 mm



Biopsy Forceps

03-5606 - 03-5609
 Handle for

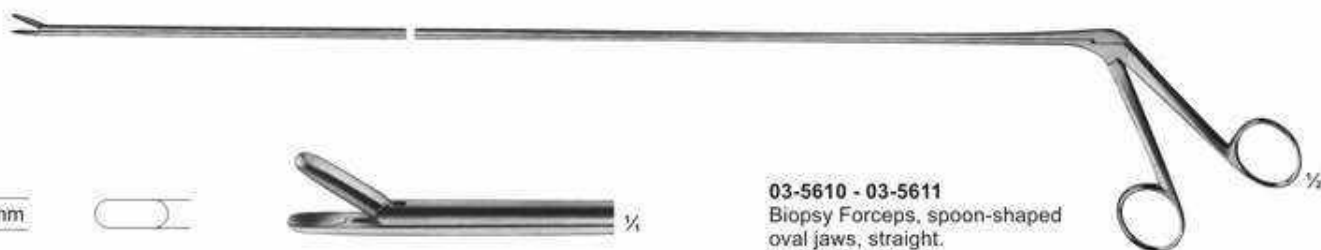

3.5 mm



Biopsy Forceps, spoon-shaped
 oval jaws, straight.
 03-5610 350mm /35 cm /14 inch
 03-5611 500mm /50 cm /20 inch

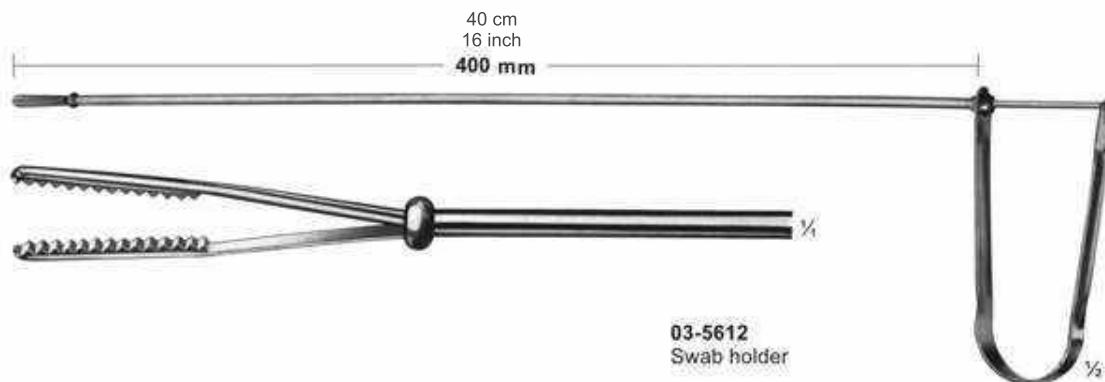

03-5612
 Swab holder

Haemorrhoidal Forceps



03-5613
 220 mm
 22cm

03-5614
 245 mm
 24.5cm
 10 Inch

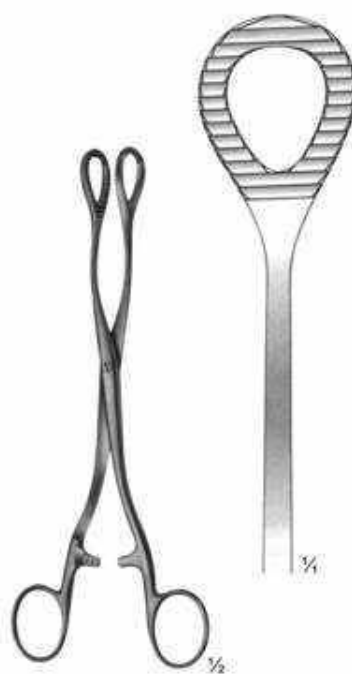

03-5615
 HEYWOOD-SMITH
 200 mm
 20cm
 8 Inch



03-5616
 HEYWOOD-SMITH
 modif
 215 mm
 21.5cm
 8 Inch

Haemorrhoidal Forceps

Atraumata

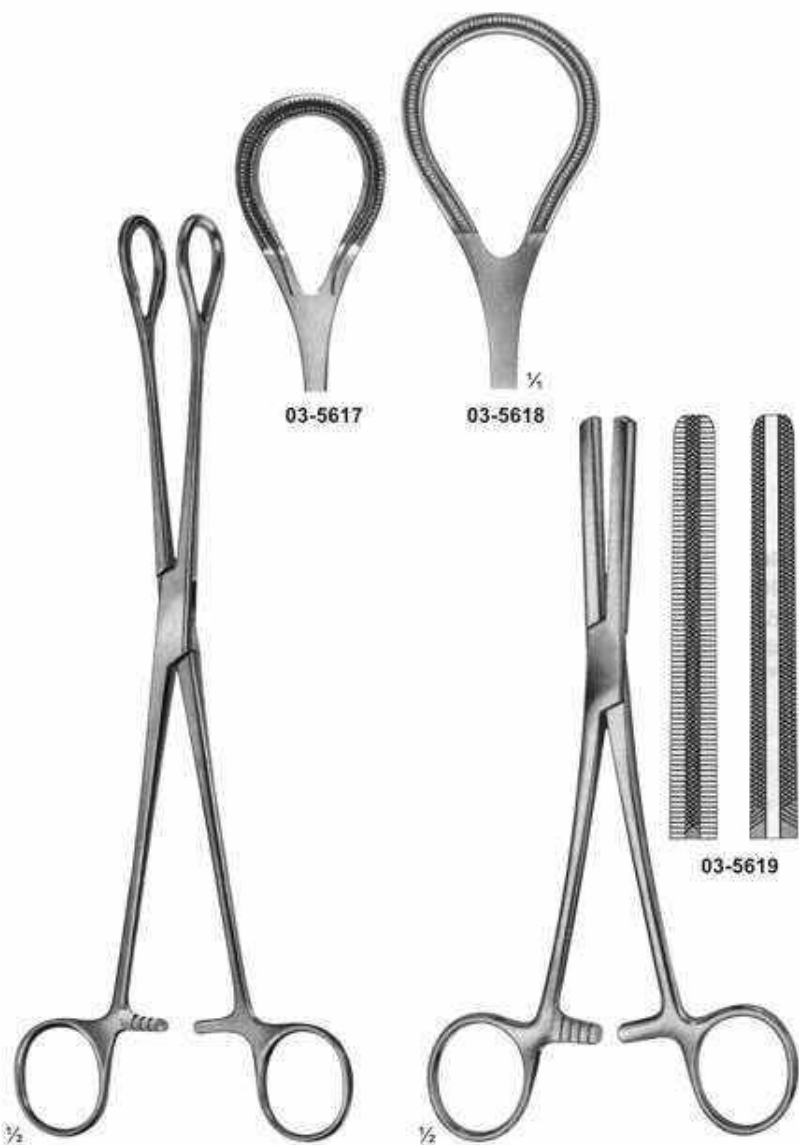

03-5617
 250 mm
03-5618
 270 mm
 27cm
 11 Inch

03-5619 - 03-5620
FERGUSSON
 200 mm
 20cm
 8 Inch

Pressure Clamp



03-5621
RUDD
 Haemorrhoidal ligator
 with loading
 attachment and 100
 ligature rubber rings
 315 mm /31.5cm /12 Inch

Gall Duct Forceps



03-5622
LOWER
180 mm / 18cm / 7 Inch



03-5623
LAHEY (SWEET)
190 mm / 19cm / 7 Inch



03-5624
LAHEY
220 mm / 22cm / 9 Inch



03-5625
DESJARDINS
Gall duct and cystic forceps
210 mm / 21cm / 8 Inch



03-5626
NISSEN
Gall duct and cystic forceps
215 mm / 21.5cm / 8 Inch

Gall Duct Forceps and Choledochus Forceps

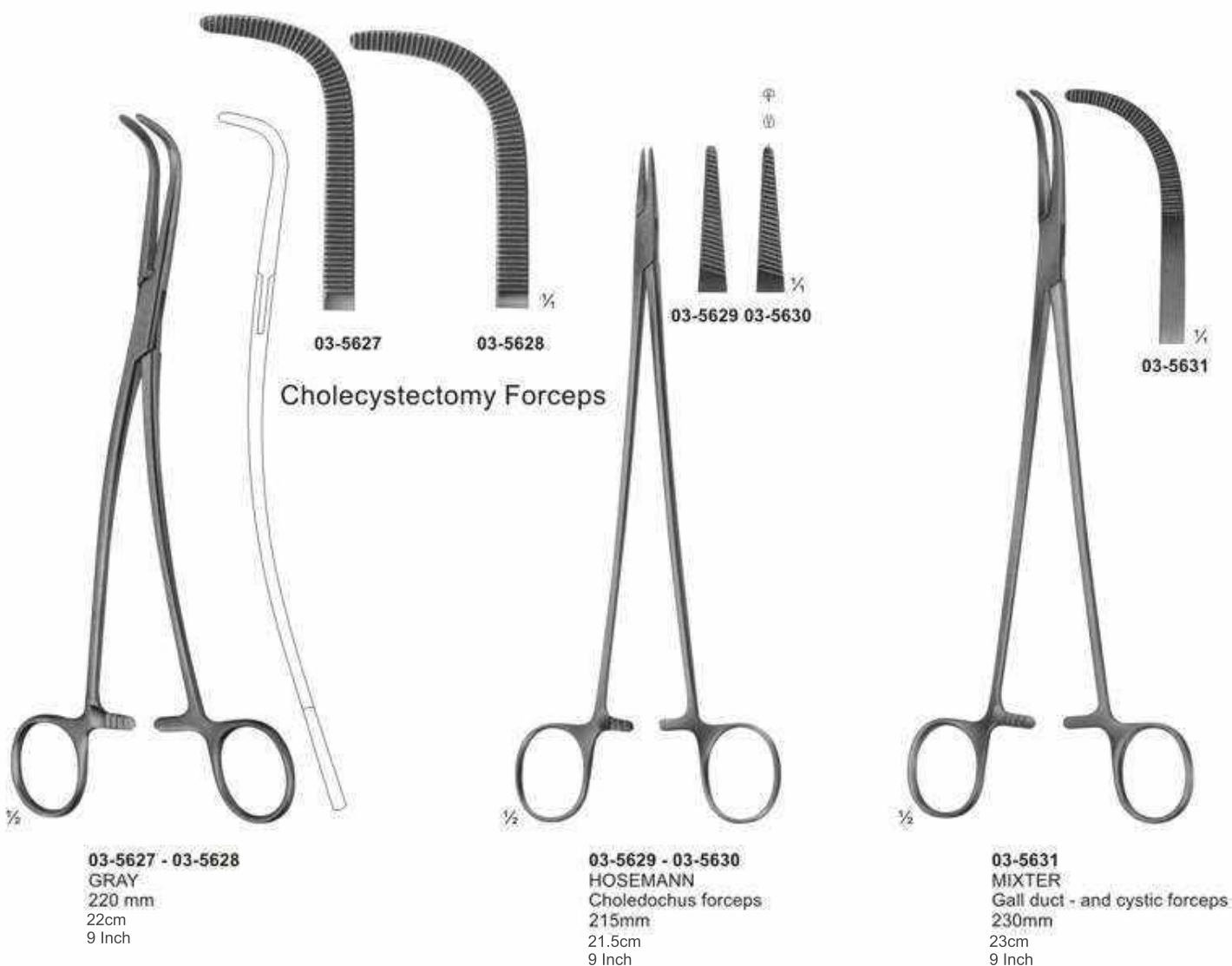

Cholecystectomy Forceps

03-5627 - 03-5628
 GRAY
 220 mm
 22cm
 9 Inch

03-5629 - 03-5630
 HOSEMANN
 Choledochus forceps
 215mm
 21.5cm
 9 Inch

03-5631
 MIXTER
 Gall duct - and cystic forceps
 230mm
 23cm
 9 Inch

Gall Bladder Forceps and Gall Duct Scissors

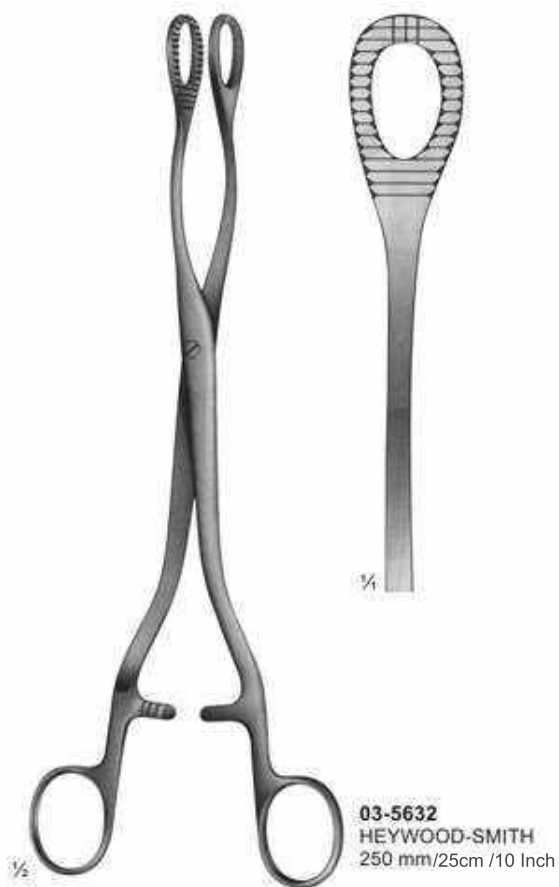

03-5635
HEYWOOD-SMITH
200 mm
20cm
8 Inch



03-5636
DOYEN
185 mm
18.5cm
7 Inch



03-5637 - 03-5638
Gall duct scissors
220 mm/22cm /9 Inch



Gall Duct Probes

Ø 3.5 mm



1/2
03-5639
HAJEK
Irrigating cannula,
silver
165 mm
16.5cm
6 Inch

Ø 5 mm



1/2
03-5640
MOYNIHAN
Gall stone probe
and scoop of tin,
malleable.
365 mm
36.5cm
14 Inch

Ø 5 mm



1/2
03-5641
MAYO
Gall duct probes,
malleable
330 mm
33cm
13 Inch

Ø 3.5 mm

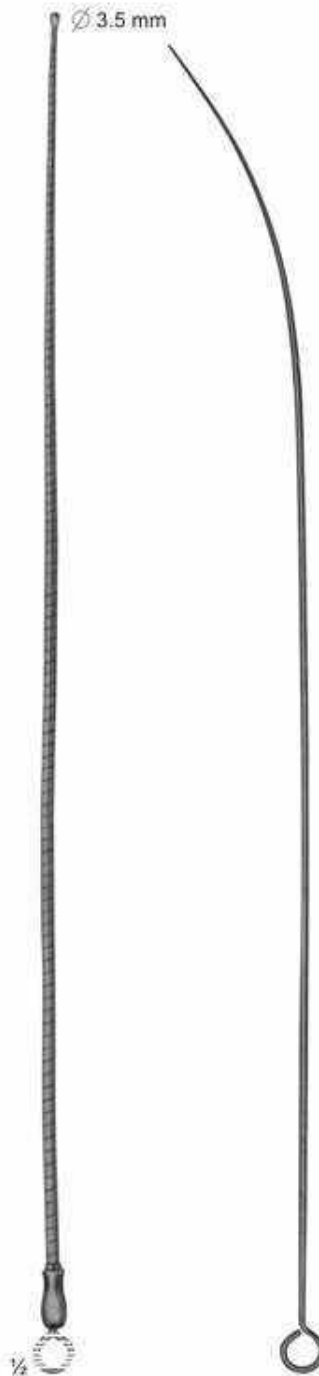

1/2
03-5642
OCHSNER
Gall duct probes, flexible
400 mm
40cm
16 Inch

Ø 3.8 mm



1/2
03-5643



1/2
03-5644
Ø 4.3mm



1/2
03-5645
Ø 6.8mm

03-5643 - 03-5645
DESJARDINS
Gall duct probes,
flexible
285 mm
28.5cm
11 Inch



Gall Duct Dilators & Gall Stone Scoops



**Charr
(French)**

- 03-5646 8
- 03-5647 9
- 03-5648 10
- 03-5649 11
- 03-5650 12
- 03-5651 13
- 03-5652 14
- 03-5653 15
- 03-5654 16
- 03-5655 17
- 03-5656 18
- 03-5657 19
- 03-5658 20
- 03-5659 21
- 03-5660 22
- 03-5661 23
- 03-5662 24
- 03-5663 25
- 03-5664 26
- 03-5665 27
- 03-5666 28
- 03-5667 29
- 03-5668 30

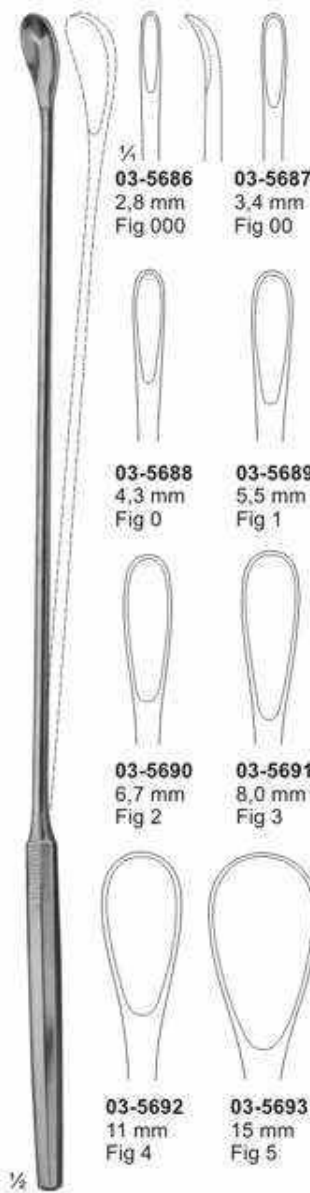
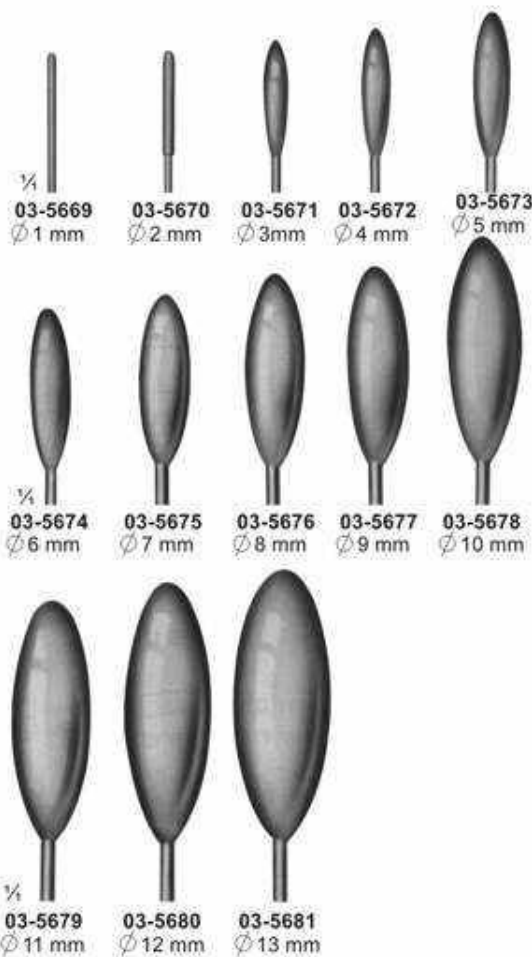

03-5646 - 03-5668
DITTEL
Metal bougies and dilating sounds, stiff
345 mm
34.5cm
14 Inch

03-5669 - 03-5681
BAKES
Common bile duct dilators, malleable
03-5669-03-5673 315mm /31.5cm /12 Inch
03-5674-03-5681 320mm /32cm /12 Inch
Set of 9 pieces (**03-5671-03-5679**)
in canvas roll

03-5682 - 03-5685
DESJARDINS
Probes and catch with flexible shaft
300 mm/30cm /12 Inch

03-5686 - 03-5693
LUER-KOERTE
modif with malleable shaft
310 mm/30cm /12 Inch

Gall Stone Forceps

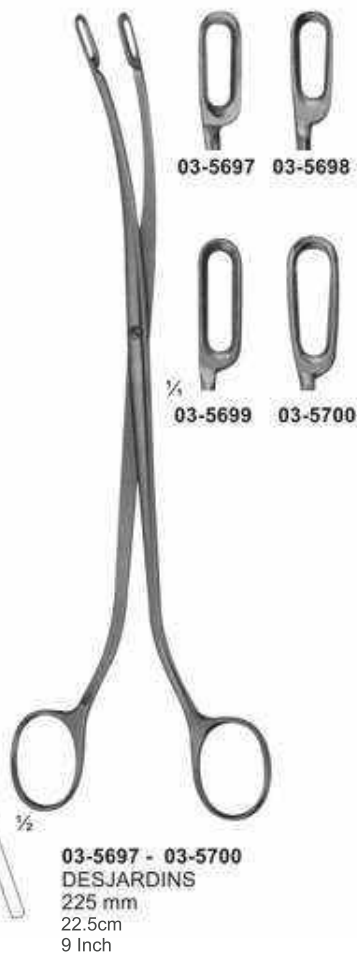
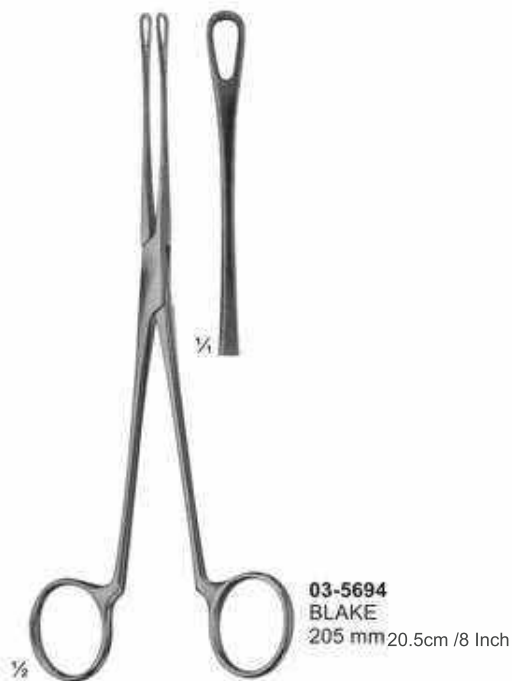

Kidney Clamps

Atraumata

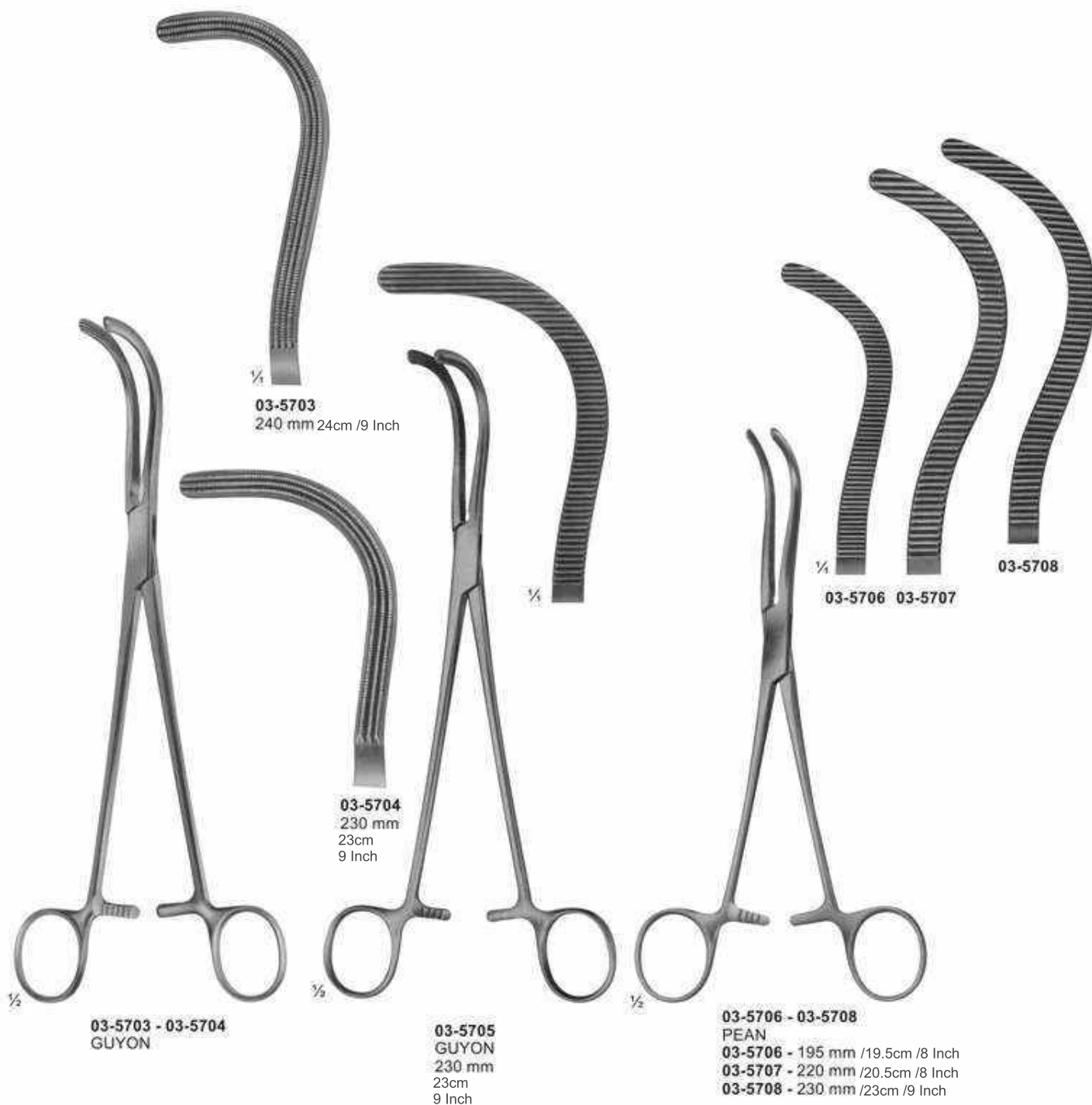

Kidney and Pedicle Clamps



03-5709
STILLE
 220 mm
 20.5cm
 8 Inch

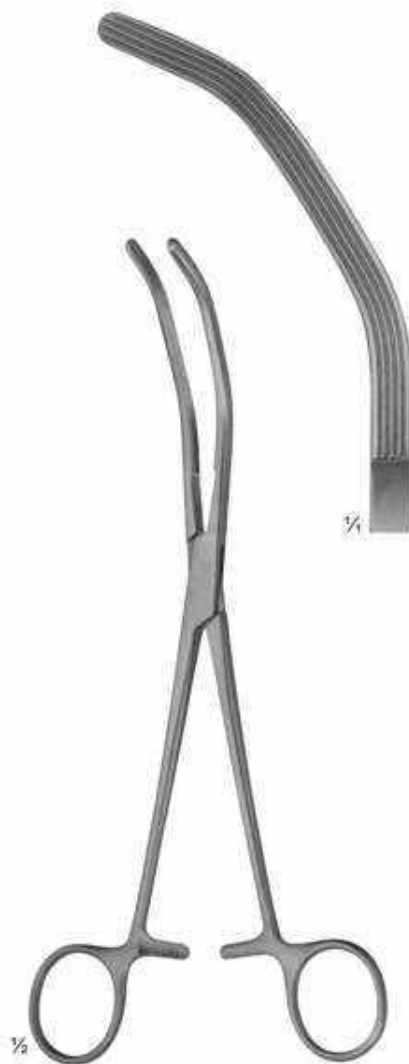

03-5710
HERRICK
 225 mm
 22.5cm
 9 Inch



03-5711
WERTHEIM
 225 mm
 22.5cm
 9 Inch

Kidney Elevating Forceps



½
03-5712
COLLIN
285 mm
28.5cm
11 Inch



½
03-5713
DARTIGUES
255 mm
25.5cm
10 Inch

Kidney Stone Forceps



03-5714



03-5715



03-5716



03-5717



1/2

03-5714 - 03-5717
 RANDALL
 225 mm
 25.5cm
 10 Inch



03-5718



03-5719



1/2

03-5718 - 03-5719
 RANDALL
 190 mm
 19cm
 7 Inch

Bladder Retractors



03-5720
JUDD-MASSON
Bladder-and suprapubic
retractor

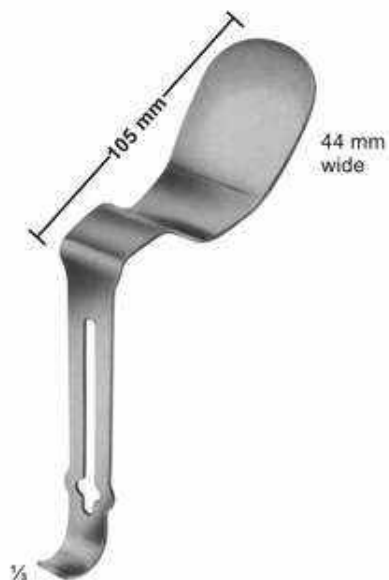

03-5721
MILLIN
Center blade for (05-6993)
retro pubic prostatectomy.



03-5722
MILLIN
Bladder retractor
03-5722 Spreader only
03-5723 Blades 57x25mm
03-5724 Blades 82x25mm
03-5725 Center blade 105x45mm



03-5726
LEGUEU
Bladder retractor
Center blade



03-5727
LEGUEU
Bladder spatula
260 mm 26cm / 10 Inch



03-5728
KOCHER
Bladder spatula
235 mm 23.5cm / 9 Inch

Genito-Urinary Instruments



03-5729
MATHIEU
 Foreign body forceps
 Length of shaft
 190 mm 19.5cm / 8 Inch



03-5730
MILLIN
 Lobe grasping
 forceps
 235 mm 23.5cm / 9 Inch

Atraumata



03-5731
Ureter forceps
 240 mm
 24cm
 9 Inch

Atraumata



03-5732
MILLIN
 Lobe grasping
 forceps
 245 mm
 24.5cm
 10 Inch



03-5733
MILLIN
 Bladder neck spreader
 285 mm
 28.5cm
 11 Inch

Genito-Urinary Instruments



03-5734
GUYON
 Catheter guide
 (introducer)
 365 mm

Charr.
 (French)

03-5735 6
 03-5736 7
 03-5737 8
 03-5738 9
 03-5739 10
 03-5740 11
 03-5741 12
 03-5742 13
 03-5743 14
 03-5744 15
 03-5745 16
 03-5746 18
 03-5747 20



03-5735 - 03-5747
 Female catheters,
 metal
 160 mm / 16cm / 6 Inch

Charr.
 (French)

03-5748 8
 03-5749 9
 03-5750 10
 03-5751 11
 03-5752 12
 03-5753 13
 03-5754 14
 03-5755 15
 03-5756 16
 03-5757 17
 03-5758 18
 03-5759 19
 03-5760 20
 03-5761 21
 03-5762 22
 03-5763 23
 03-5764 24
 03-5765 25
 03-5766 26
 03-5767 27
 03-5768 28
 03-5769 29
 03-5770 30

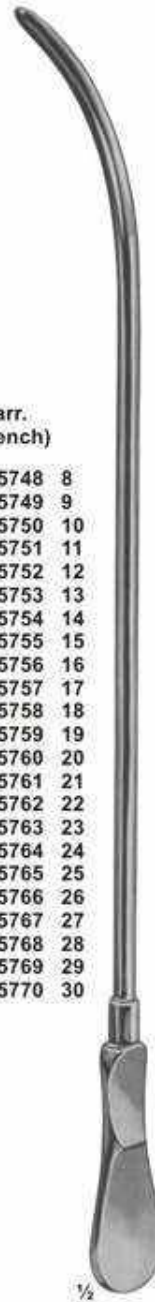

03-5748 - 03-5770
DITTEL
 Urethral bougies
 and dilating sounds
 345 mm / 24.5cm / 10 Inch

03-5771 Ben. 24/Charr. 12
 03-5772 Ben. 25
 03-5773 Ben. 26/Charr. 13
 03-5774 Ben. 27
 03-5775 Ben. 28/Charr. 14
 03-5776 Ben. 29
 03-5777 Ben. 30/Charr. 15
 03-5778 Ben. 31
 03-5779 Ben. 32/Charr. 16
 03-5780 Ben. 33
 03-5781 Ben. 34/Charr. 17
 03-5782 Ben. 35
 03-5783 Ben. 36/Charr. 18
 03-5784 Ben. 37
 03-5785 Ben. 38/Charr. 19
 03-5786 Ben. 39
 03-5787 Ben. 40/Charr. 20
 03-5788 Ben. 41
 03-5789 Ben. 42/Charr. 21
 03-5790 Ben. 43
 03-5791 Ben. 44/Charr. 22
 03-5792 Ben. 45
 03-5793 Ben. 46/Charr. 23
 03-5794 Ben. 47
 03-5795 Ben. 48/Charr. 24
 03-5796 Ben. 49
 03-5797 Ben. 50/Charr. 25
 03-5798 Ben. 51
 03-5799 Ben. 52/Charr. 26
 03-5800 Ben. 53
 03-5801 Ben. 54/Charr. 27
 03-5802 Ben. 55
 03-5803 Ben. 56/Charr. 28
 03-5804 Ben. 57
 03-5805 Ben. 58/Charr. 29
 03-5806 Ben. 59
 03-5807 Ben. 60/Charr. 30



03-5771 - 03-5807
GUYON
 Urethral bougies
 and dilating sounds,
 without filiform guides,
 with thread in tip
 255 mm / 25.5cm / 10 Inch

Genito-Urinary Instruments & Circumcision Clamp



03-5808
GUYON
 Set of urethral bougies and dilating sounds,
 in metal case, with lift out rack and bottom
 rack, containing 21 urethral and dilating sounds, metal.



03-5809 - 03-5811
WINKELMANN
03-5809 ∅ 12mm
03-5810 ∅ 16mm
03-5811 ∅ 20mm

Circumcision Clamps

Assisted by two haemostats or ligatures the foreskin is pushed over the bellshaped protection - rod and the glans is placed into it.
 By now, the wing - nut is tightened as close as possible, so the foreskin in annular compressed. The foreskin is cut of with a scalpel, right next to the compression ring. The circumcision clamp remains a few minutes to avoid bleeding. In case that any large vein, specially the frenular artery, is cut through, a ligature must be set.
 The advantage of the method described is the cosmeticly favourable scar which is left after rejection of the small necrotized portion.

Trocars

Luer Lock



03-5812
KLIMA ROSEGGER
35 X 1,8 mm
Sternal puncture needle

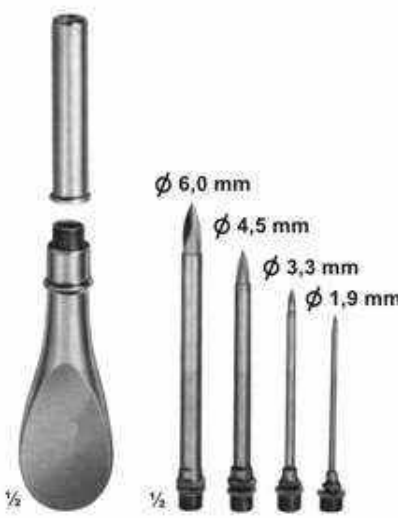

03-5813
Universal trocar
with 4 tips

Ø 6,0 mm
Ø 4,5 mm
Ø 3,3 mm
Ø 1,9 mm



03-5814 - 03-5818
NELSON

	Inside diam	Outside diam
03-5814	2,2 mm	3,0 mm
03-5815	3,0 mm	4,0 mm
03-5816	4,0 mm	5,0 mm
03-5817	5,0 mm	6,0 mm
03-5818	5,5 mm	6,5 mm

for hydrocele and abdominal puncture



03-5819 - 03-5822

	Inside diam	Outside diam
03-5819	2,2 mm	3,0 mm
03-5820	3,0 mm	4,0 mm
03-5821	4,0 mm	5,0 mm
03-5822	5,0 mm	6,0 mm

for abdominal puncture,
with stop-cock and lateral drain



03-5823 100 mm
03-5824 110 mm

03-5823 - 03-5824
BUELAU

	Inside diam	Outside diam
03-5823	6,5 mm	8,0 mm
03-5824	9,0 mm	10,0 mm

Empyema trocar



03-5825 - 03-5828
OCHSNER

	Inside diam	Outside diam
03-5825	3,0 mm	4,0 mm
03-5826	3,6 mm	4,6 mm
03-5827	4,3 mm	5,3 mm
03-5828	5,0 mm	6,0 mm

Cell bladder trocars



03-5829
PIERCE
Antrum trocar
Ø 4,0 mm



03-5830
COAKLEY
Antrum trocar
Ø 3,0 mm

Section - 04



Pages 218-264

- ★ Vaginal Specula & Retractors
- ★ Utrine Dilators, Probes, Forceps, Myoma Instruments
- ★ Biopsy Instruments, Utrine Curettes / Scoops
- ★ Obstetrics Instruments



DENTELO SURGICAL
INTERNATIONAL
Serving World of Surgical Since 1996.

Vaginal specula

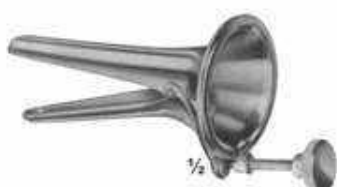

04-6001
COLLIN
for children
53 x 10 mm

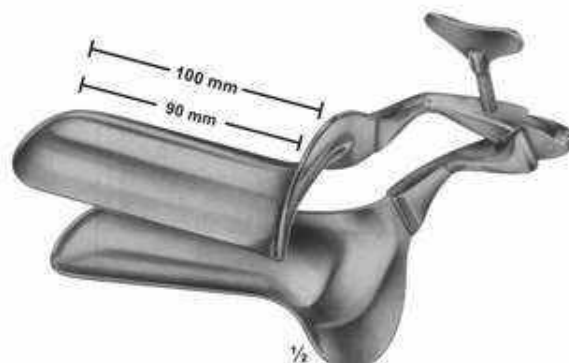

04-6002 - 04-6005
COLLIN

04-6002	100/90mm	28 mm
04-6003	100/90mm	32 mm
04-6004	105/95mm	35 mm
04-6005	115/105mm	40 mm
Total length/working length		width



04-6006
COLLIN
for virgins
95/85 x 18 mm



04-6007
CUSCO
for virgins
75 x 17 mm



04-6008
CUSCO
for virgins
75 x 17 mm

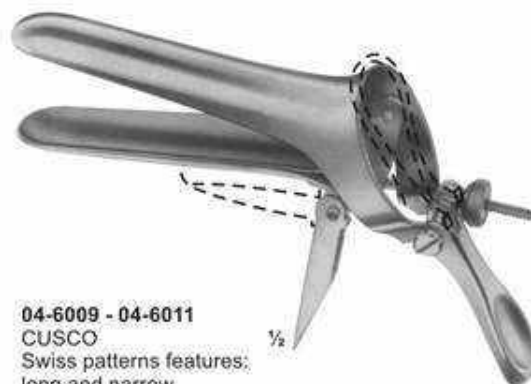

04-6009 - 04-6011
CUSCO
Swiss patterns features:
long and narrow

04-6009	92x23-25 mm
04-6010	100x25-27 mm
04-6011	110x27-30 mm

Vaginal Specula



04-6012 - 04-6015
CUSCO
STANDARD
04-6012 80X24 mm
04-6013 80X32 mm
04-6014 90X36 mm
04-6015 110X37 mm



04-6016 - 04-6019
CUSCO
04-6016 80X24 mm
04-6017 80X32 mm
04-6018 90X36 mm
04-6019 110X37 mm



Flat (duck beak)

04-6020 - 04-6022
CUSCO
04-6020 80X32 mm
04-6021 90X37 mm
04-6022 115X37 mm



04-6023 - 04-6024
SEYFFERT
04-6023 100X17 mm
04-6024 110X33 mm
230 mm 23cm /10 Inch



With double ratchet, closing and opening of ratchet by pressure of thumb

04-6025
SEMM
for children and virgins
180 mm 18cm /7 Inch

Vaginal Specula, Sets, Upper & Lower Blades



Vaginal Specula-Sets, upper and lower blades



Vaginal Specula-upper and lower blades

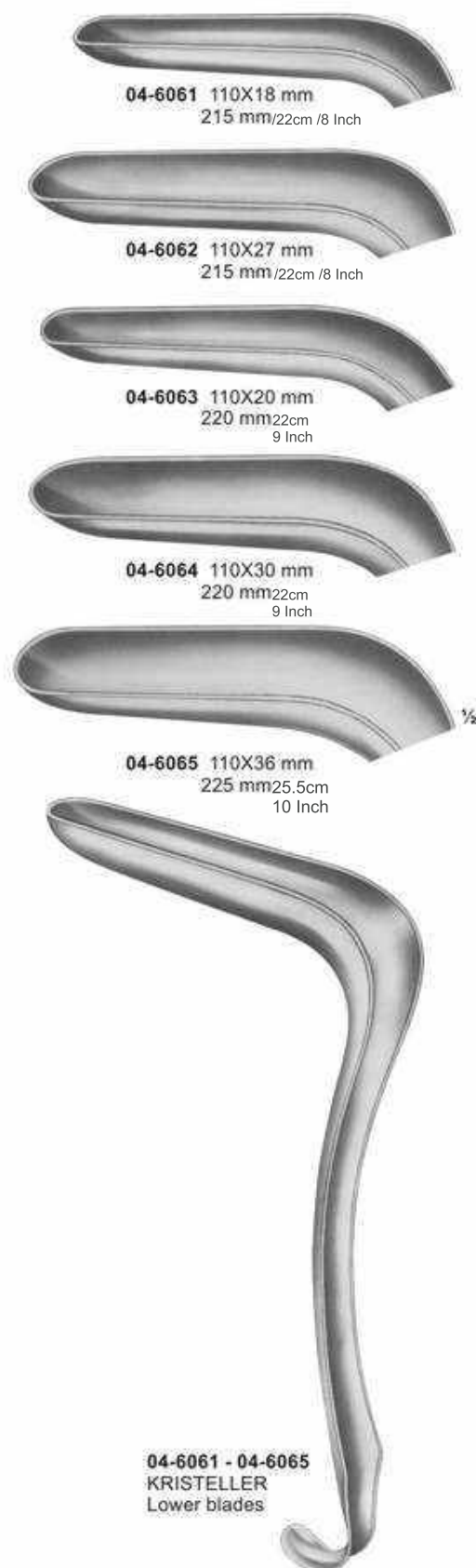
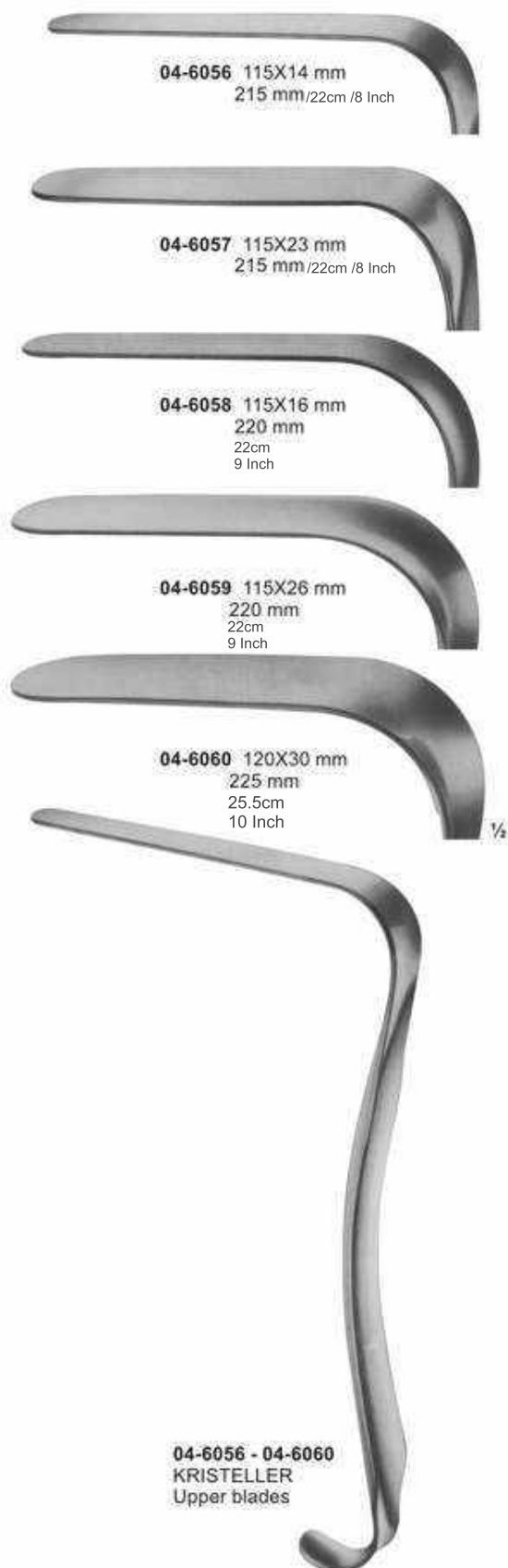

Vaginal Specula



04-6066
80 X 28 mm



04-6067
85 X 35 mm



04-6068
85 X 40 mm



Slightly Concave

½

04-6066 - 04-6068
KRISTELLER
205 mm
20.5cm
8 Inch



04-6069
76 X 38 mm



04-6070
89 X 38 mm



04-6071
102 X 38 mm



Slightly Concave

½

04-6069 - 04-6071
JACKSON
175 mm/20.5cm /8 Inch

Vaginal Specula-for children & virgins

Vario Retractor

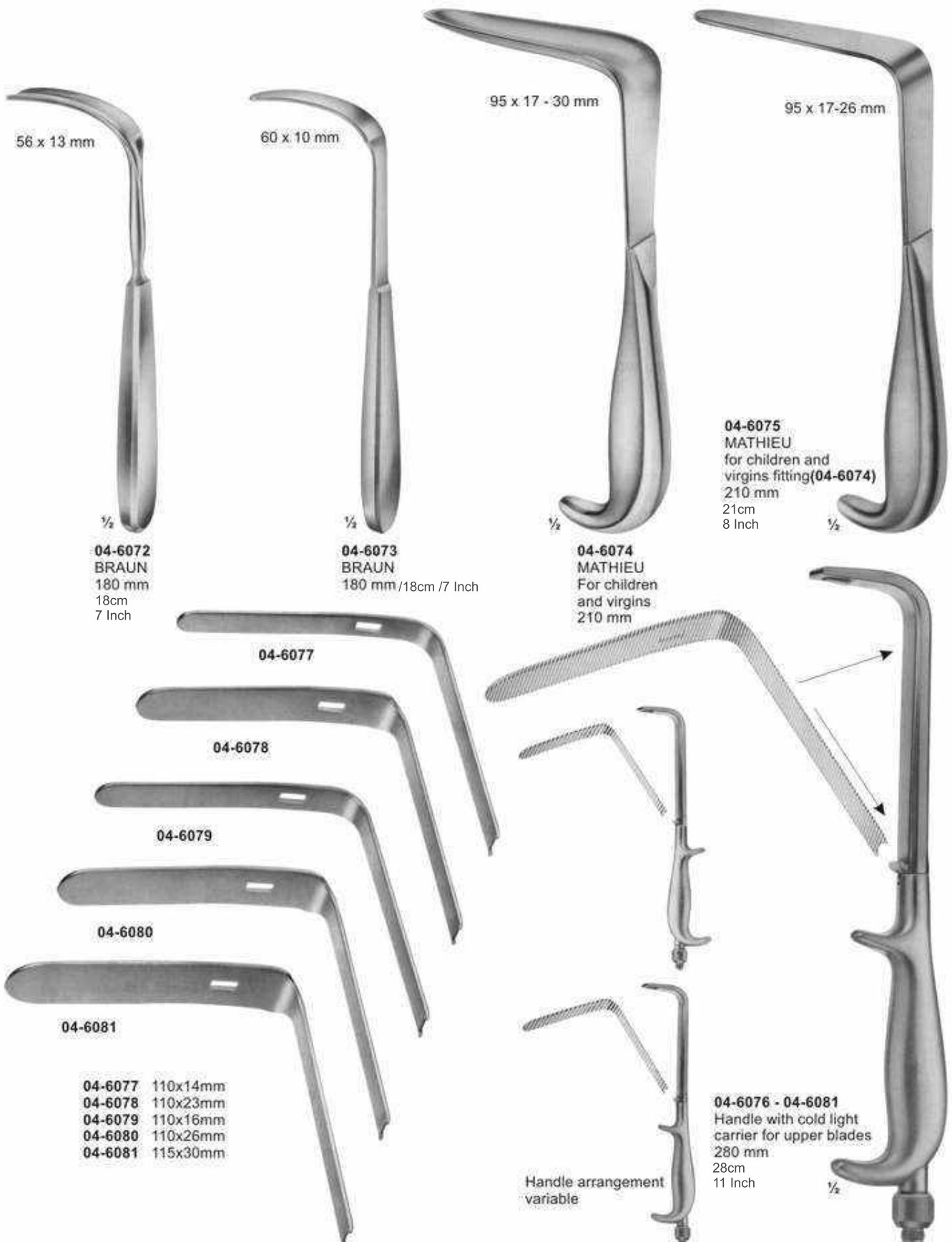

Vaginal Specula-for children and virgins



04-6082 - 04-6084
 DOYEN
 235 mm
 23.5cm
 9 Inch

Length of blades	Width of blades			1/2
	35 mm	45 mm	60 mm	
60 mm	04-6085	04-6088	04-6091	04-6085 - 04-6094 DOYEN 240mm/24cm /9 Inch
90 mm	04-6086	04-6089	04-6092	
120 mm	04-6087	04-6090	04-6093	
160 mm		04-6090A	04-6094	

Vaginal Specula / Retractors



04-6095 - 04-6099
 BREISKY
 WIENER MODELL/
 VIENNA PATTERN
04-6095 100 X 20 mm
04-6096 100 X 25 mm
04-6097 100 X 30 mm
04-6098 100 X 35 mm
04-6099 100 X 40 mm
 300 mm /30cm /12 Inch



04-6100 - 04-6104
 BREISKY
 WIENER MODELL/
 VIENNA PATTERN
04-6100 130 X 20 mm
04-6101 130 X 25 mm
04-6102 130 X 30 mm
04-6103 130 X 35 mm
04-6104 130 X 40 mm
 320 mm /32cm /12 Inch



04-6107
 removable strainer only

04-6105 - 04-6106
 WEISSBARTH
04-6105 80 X 28 mm
04-6106 85 X 42 mm
 210 mm/21cm /8 Inch



04-6108
 DOYEN
 lateral speculum
 80 x 30 mm
 250 mm/25cm /10 Inch

Vaginal & Wound Retractor / Vaginal Specula



04-6110
115 X 26 mm
275 mm
27.5cm
11 Inch

04-6109 - 04-6110
SIMON
115 X 22 mm
275 mm / 27.5cm / 11 Inch

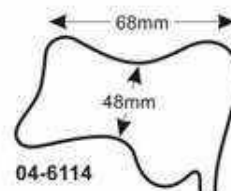

04-6114



04-6115

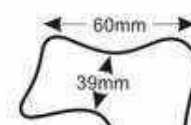

04-6116



04-6117



04-6111
AUVARD
65 X 38 mm - 28 mm
1,530 kg = 3 lbs
with fixed weight
230 mm
30cm
12 Inch

04-6112 - 04-6113
AUVARD
04-6112 75 X 42-40 mm
04-6113 105 X 43-40 mm
1,470 kg = 3 lbs
with detachable weight
230 mm / 30cm / 12 Inch

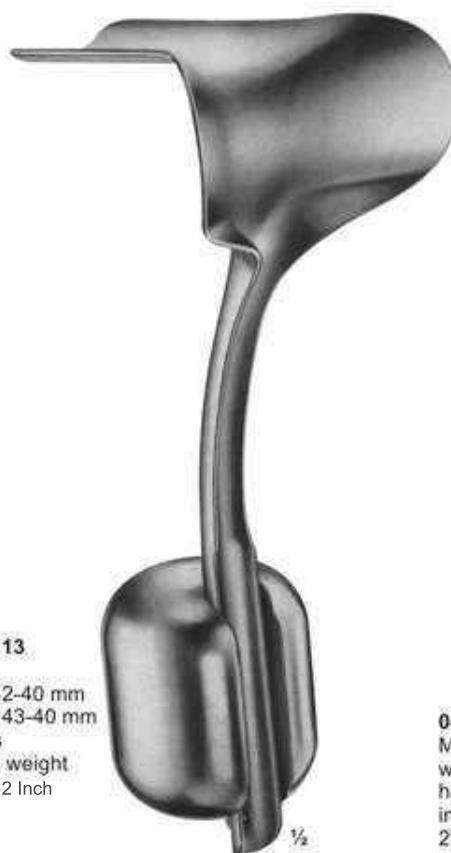

04-6114 - 04-6117
MARTIN
with hook shaped
handle for hanging
in weights.
270 mm / 27cm / 11 Inch



Vaginal Speculas

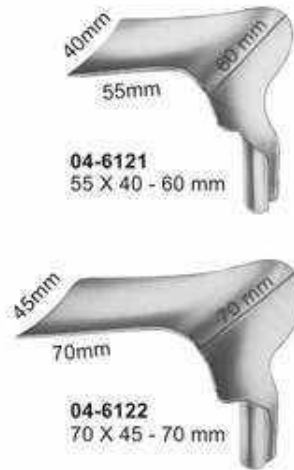

The mentioned blades (04-6118 - 04-6122 and 04-6125 - 04-6132) can be exchanged. They fit handle (04-6123), as well as handles (04-6133 and 04-6134).

04-6118 - 04-6124
SCHERBACK
Set consisting of:
handle 04-6123
weight 04-6124
4 blades 04-6118 - 04-6121



04-6133
BOZEMANN
Set consisting of:
2 handle (04-6133 - 04-6134)
8 blades (04-6125 - 04-6132)

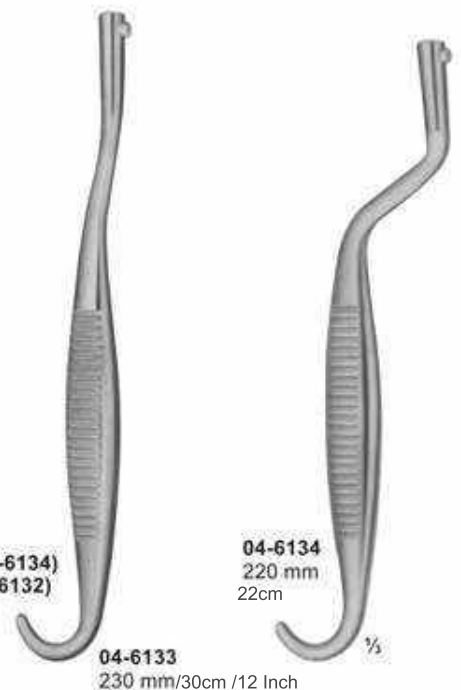

Vaginal Retractors



½
04-6135
JOLL (FRIEDMAN)
 155 mm /15.5cm /6 Inch



½
04-6136
RICHTER
 170 mm/17cm /7 Inch



½
04-6137
GELPI
 135 mm/13.5cm /5 Inch



½
04-6138
GELPI
 175 mm/17.5cm /7 Inch

Uterine Dilators



¼

04-6139	1	mm	04-6161	23	mm
04-6140	2	mm	04-6162	24	mm
04-6141	3	mm	04-6163	25	mm
04-6142	4	mm	04-6164	26	mm
04-6143	5	mm	04-6165	1	½mm
04-6144	6	mm	04-6166	2	½mm
04-6145	7	mm	04-6167	3	½mm
04-6146	8	mm	04-6168	4	½mm
04-6147	9	mm	04-6169	5	½mm
04-6148	10	mm	04-6170	6	½mm
04-6149	11	mm	04-6171	7	½mm
04-6150	12	mm	04-6172	8	½mm
04-6151	13	mm	04-6173	9	½mm
04-6152	14	mm	04-6174	10	½mm
04-6153	15	mm	04-6175	11	½mm
04-6154	16	mm	04-6176	12	½mm
04-6155	17	mm	04-6177	13	½mm
04-6156	18	mm	04-6178	14	½mm
04-6157	19	mm	04-6179	15	½mm
04-6158	20	mm	04-6180	16	½mm
04-6159	21	mm	04-6181	17	½mm
04-6160	22	mm			

04-6139 - 04-6181
HEGAR
with very conical point:
185 mm /18.5cm /7 Inch



¼

04-6182	1+2	mm
04-6183	3+4	mm
04-6184	5+6	mm
04-6185	7+8	mm
04-6186	9+10	mm
04-6187	11+12	mm
04-6188	13+14	mm
04-6189	15+16	mm
04-6190	17+18	mm

04-6182 - 04-6190
HEGAR
205 mm /20.5cm /8 Inch



¼

04-6191
HEGAR
Uterine dilator set, in canvas roll
with 8 dilators.

Uterine Dilators - Complete Sets



04-6192
 HEGAR
 Dilator set consisting of:
 14 Dilators;
 (04-6193) 1 Rack for dilators (4 - 12 mm)
 (04-6194) 1 Rack for Dilators (13 - 17 mm)
 (04-6195) 1 Metal case only,
 with hinged lid, stainless 200 X 100 X 35 mm

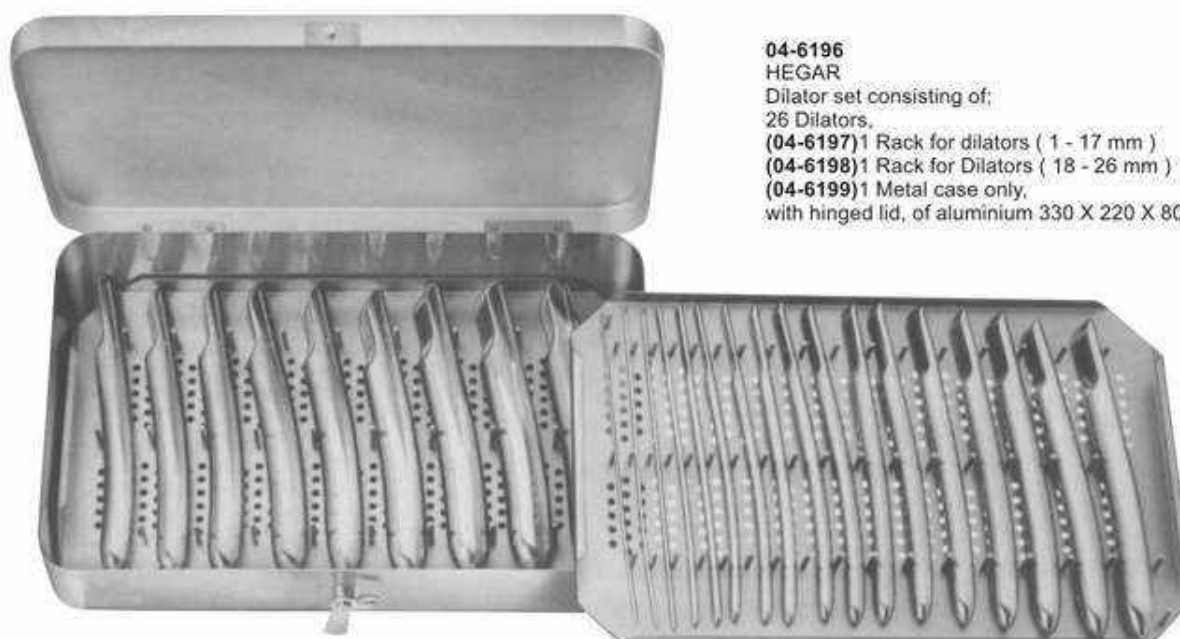

04-6196
 HEGAR
 Dilator set consisting of:
 26 Dilators,
 (04-6197) 1 Rack for dilators (1 - 17 mm)
 (04-6198) 1 Rack for Dilators (18 - 26 mm)
 (04-6199) 1 Metal case only,
 with hinged lid, of aluminium 330 X 220 X 80 mm

Endospecula For Cervix

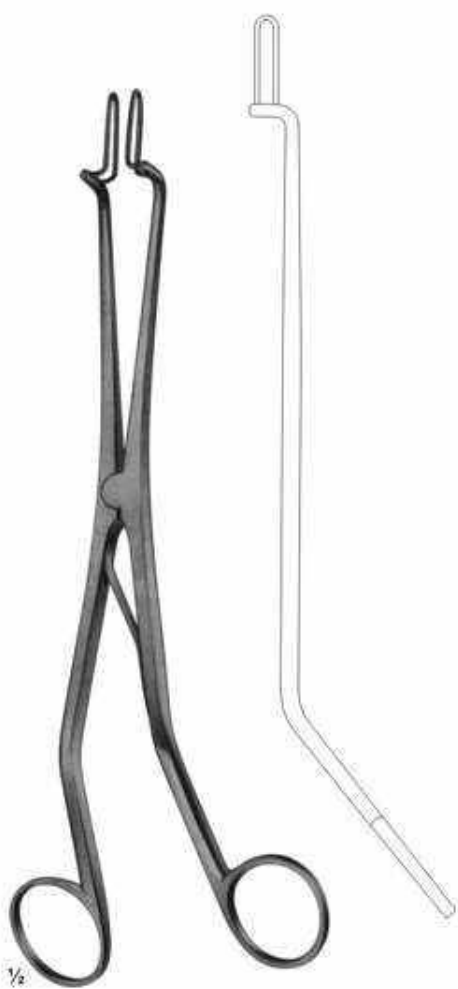

04-6200
KOGAN
 Endospecula for cervix
 and urethra, without ratchet
 240 mm / 24cm / 9 Inch



04-6201
KOGAN
 Endospecula for cervix
 and urethra, with
 scale-ratchet and fixing screws
 240 mm / 24cm / 9 Inch

Uterine Probes

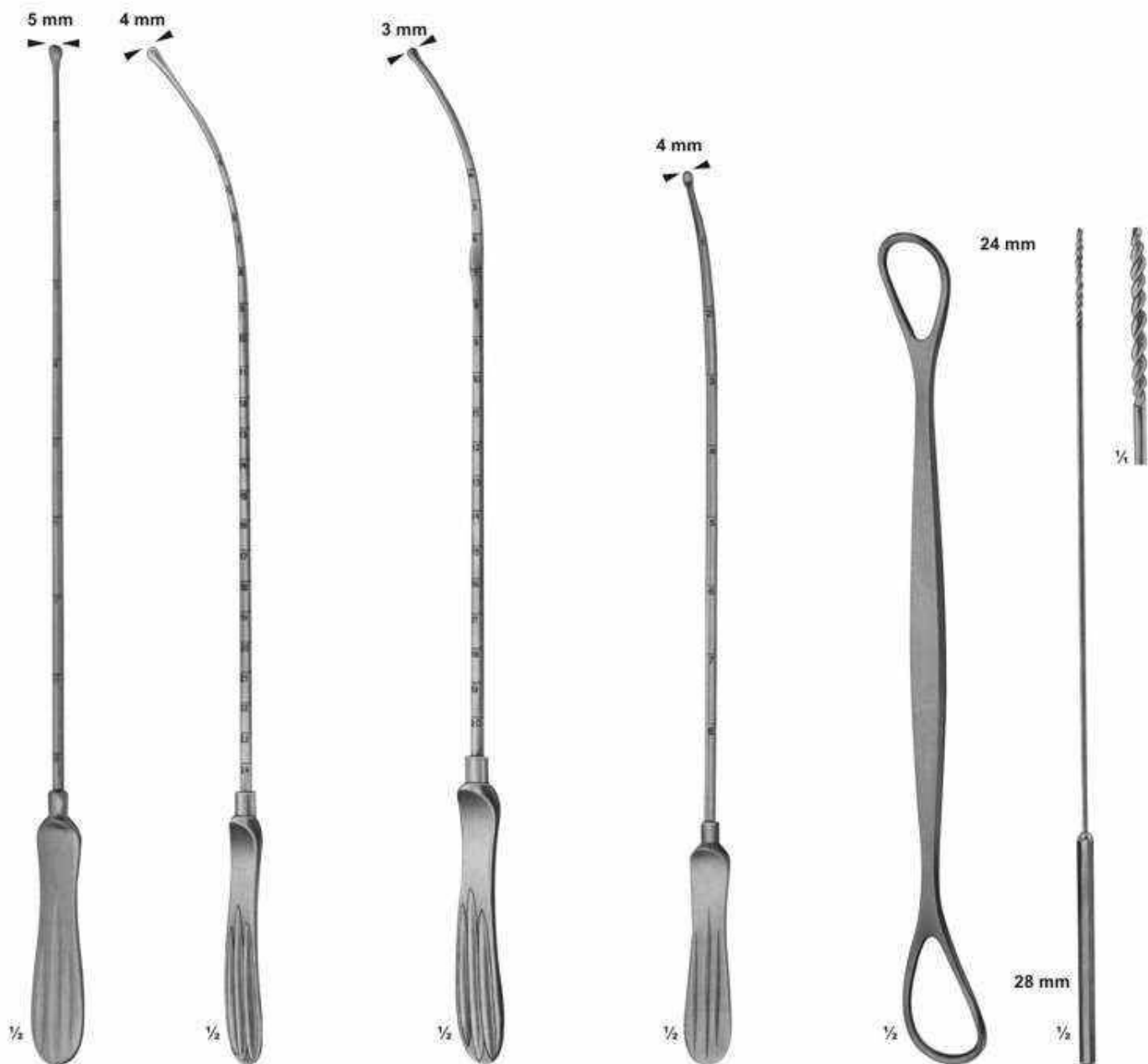

04-6202
MAYO
malleable
330 mm
33cm
13 Inch

04-6203
SIMS
malleable
330 mm /33cm /13 Inch
04-6204
SIMS
330mm

04-6205
MARTIN
330 mm
33cm
13 Inch

04-6206
SIMPSON
malleable
silver-plated
290 mm
29cm
11 Inch

04-6207
BRAUN
Uterine
depressor
270 mm
27cm
11 Inch

04-6208
Cotton
applicator
270 mm
27cm
11 Inch

Uterine Dressing Forceps



04-6209
PELKMANN
 260 mm
 26cm
 10 Inch



04-6210
PELKMANN
 260 mm
 26cm
 10 Inch



04-6211
BOZEMANN
 250 mm
 25cm
 10 Inch

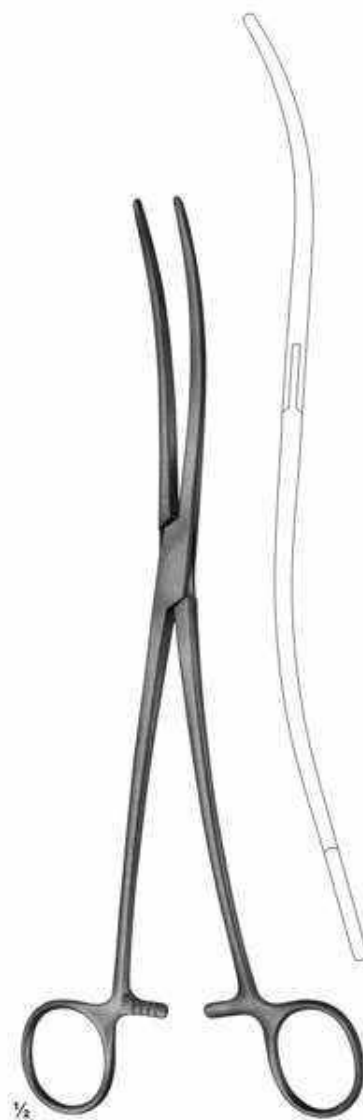

04-6212
BOZEMANN
 255 mm / 25cm / 10 Inch

Jaws with longitudinal groove

Uterine Dressing Forceps

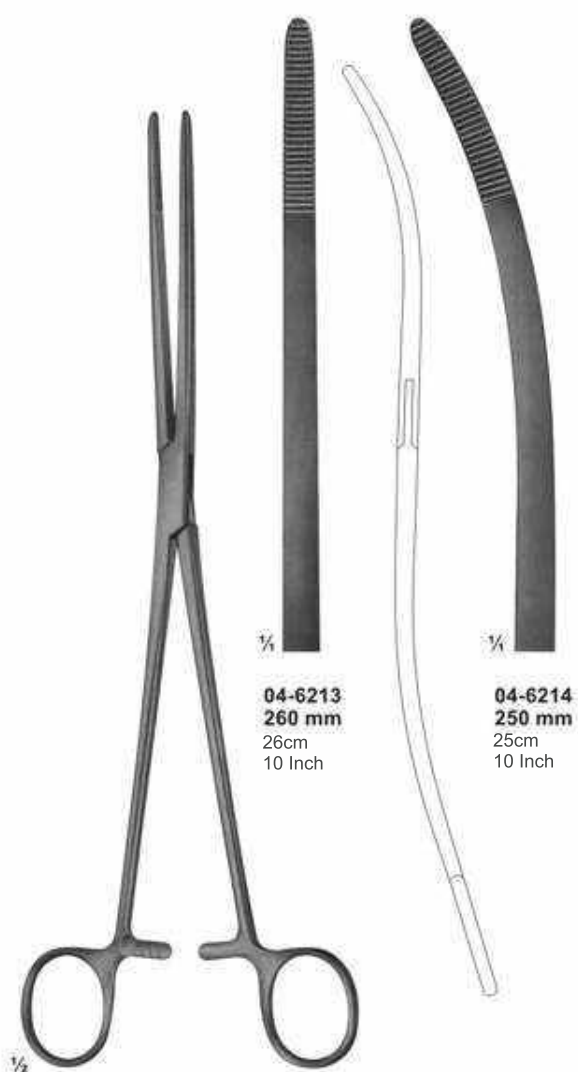

04-6213
260 mm
 26cm
 10 Inch

04-6214
250 mm
 25cm
 10 Inch

04-6213 - 04-6214
BOZEMANN



04-6215
BOZEMANN-DOUGLAS
 260 mm / 26cm / 10 Inch

Uterine Tenaculum Forceps

Standard



04-6216
BRAUN
 slender type
 250 mm
 25cm
 10 Inch



04-6217
SCHROEDER
 250 mm
 25cm
 10 Inch



04-6218
POZZI
 heavy type
 255 mm
 25.5cm
 10 Inch

Uterine Tenaculum Forceps



04-6219
MARTIN
265 mm / 26cm / 10 Inch

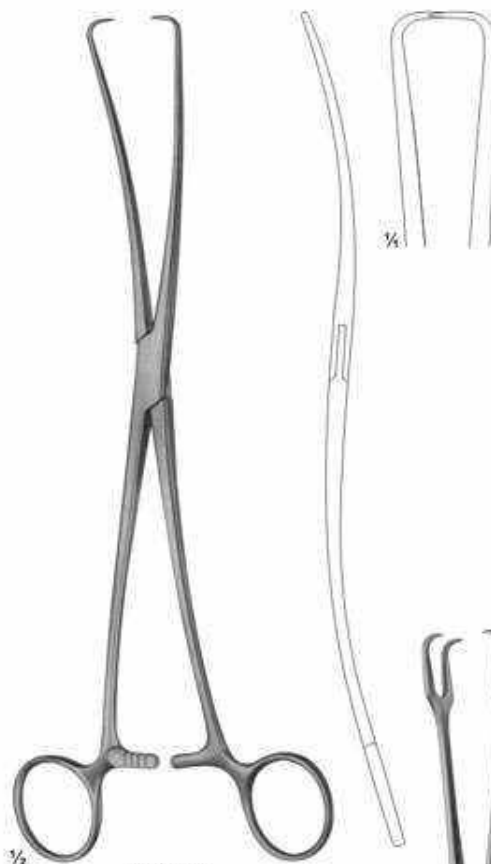

04-6220
DUPLAY
250 mm
25cm
10 Inch

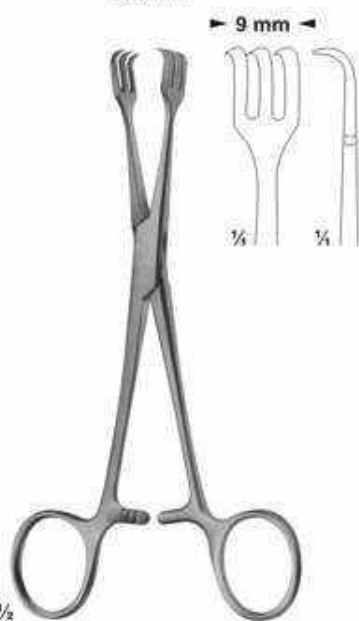
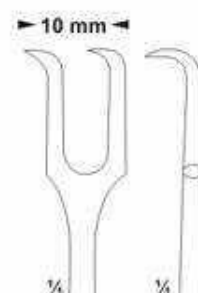

04-6221
LAHEY
155 mm
15.5cm
6 Inch



04-6222
straight

04-6223
curved
on flat

04-6224
curved
sideways

04-6222 - 04-6224
SCHROEDER
250 mm / 25cm / 10 Inch

Uterine Tenaculum Forceps

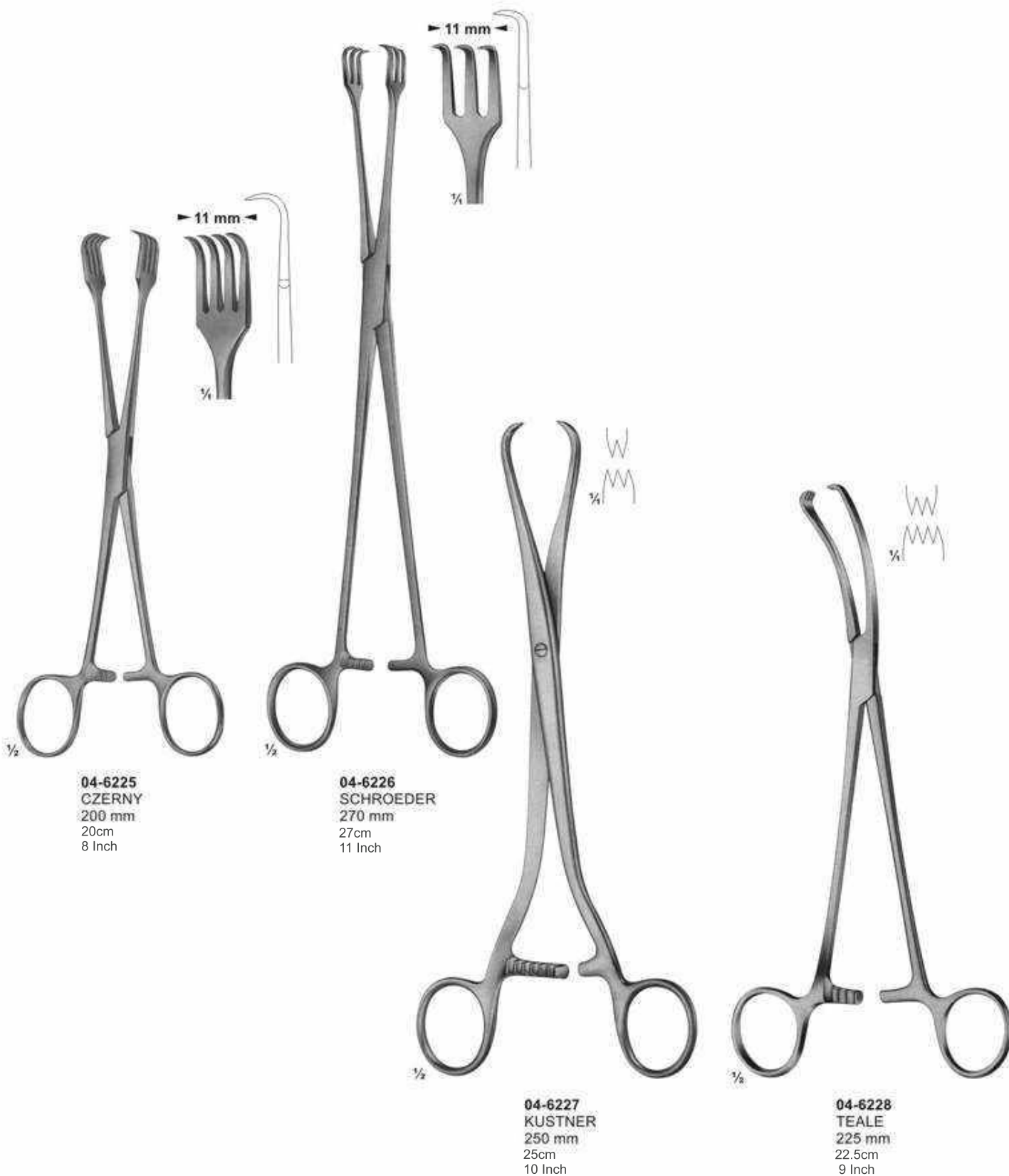

Uterine Tenaculum Forceps



04-6229
JACOBS
 215 mm / 21.5cm / 8 Inch



04-6230
LITTLEWOOD
 185 mm / 18.5cm / 7 Inch



04-6231
MUSEUX
 200 mm
 20cm / 8 Inch



04-6232

04-6233

04-6234

04-6232 - 04-6234
MUSEUX
 240 mm / 24cm / 9 Inch



04-6235

04-6236

04-6235 - 04-6236
MUSEUX
 265 mm / 26.5cm / 10 Inch



04-6237

04-6238

04-6237 - 04-6238
MUSEUX
 curved sideways
 240 mm / 24cm / 9 Inch

Polypus-and Ovum Forceps

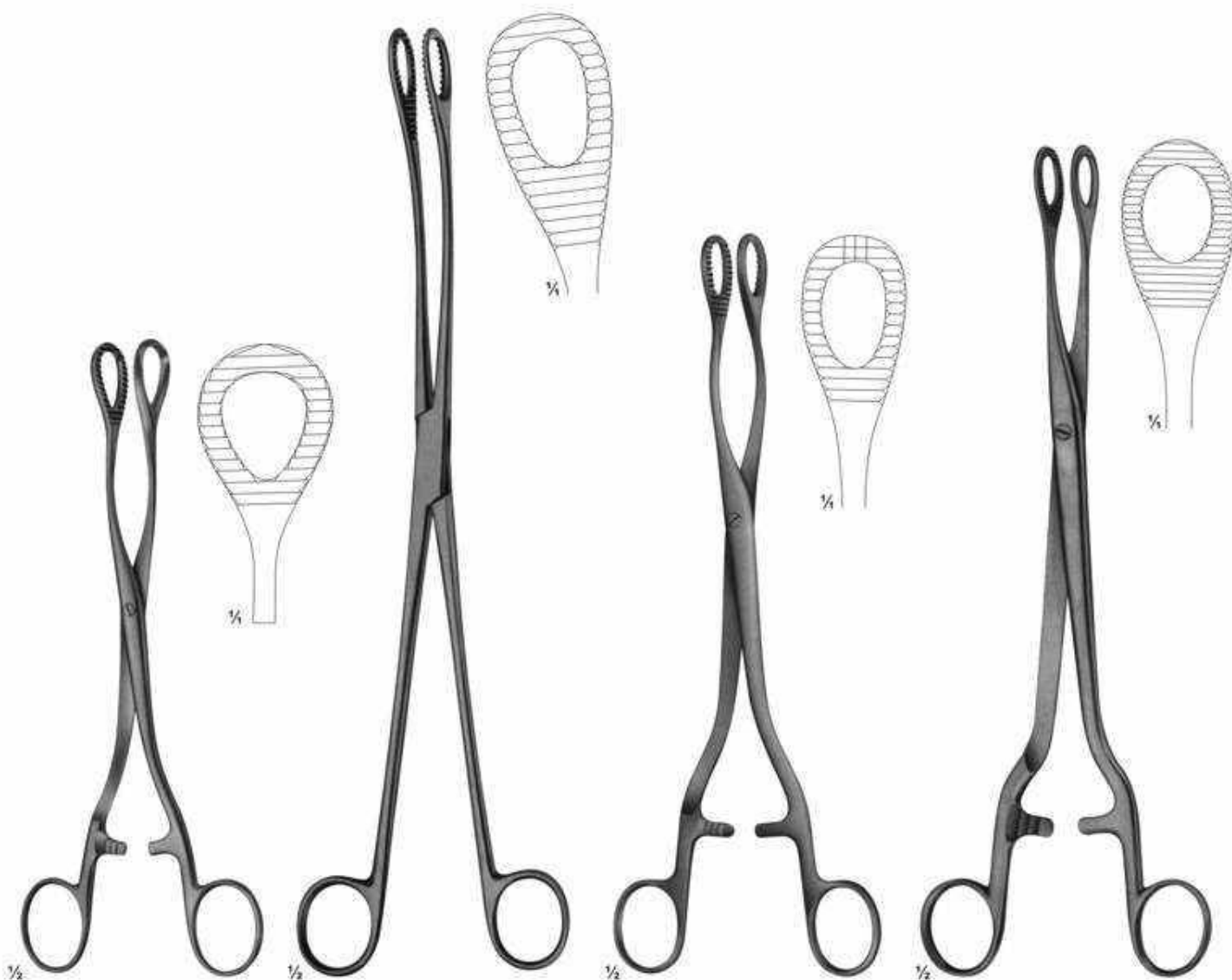

04-6239
HEYWOOD-SMITH
 200 mm
 20cm
 8 Inch

04-6240
KELLY
 320 mm
 32cm
 12 Inch

04-6241
HEYWOOD-SMITH
 250 mm
 25cm
 10 Inch

04-6242
NOTO
 280 mm
 28cm
 11 Inch

Polypus and Ovum Forceps

Atraumata



04-6244
250mm

04-6245
270mm



04-6243
DOYEN
185 mm
18.5cm
7 Inch



04-6244 - 04-6245



04-6246
BUMM
280 mm
28cm
11 Inch

Uterine Elevating Forceps



04-6247
COLLIN
 250 mm
 25cm
 10 Inch



04-6248
COLLIN
 285 mm
 28.5cm
 11 Inch



04-6249
DARTIGUES
 255 mm
 25.5cm
 10 Inch

Uterine Elevating Forceps



04-6250
SOMER
235 mm
23.5cm
9 Inch



04-6251
STRASSMANN
265 mm
26.5cm
10 Inch

Uterine Elevating Forceps

With movable jaws



04-6252
COLLIN
 265 mm/26cm /10 Inch

With movable jaws



04-6253
APPREX
 approx. 260 mm/26cm /10 Inch



Myoma Instruments, Instruments For Micro Tubal Operations



04-6254
SEGOND
Myomatome
270 mm
27cm
11 Inch



04-6255
DOYEN
Myoma screw
150 mm
15cm
6 Inch



04-6256
DOYEN
Myoma screw
190 mm
19cm
7 Inch



04-6257 **04-6258** **04-6259**
∅ 6mm ∅ 8mm ∅ 10mm

04-6257 - 04-6259
NEUBUSER
Tubal seizing forceps
200 mm/19cm /7 Inch



04-6260
Splint guide
with thread



04-6261
Splint guide with
round handle
180 mm
18cm
7 Inch



04-6262
Angled glass rods
Set . 3 pieces

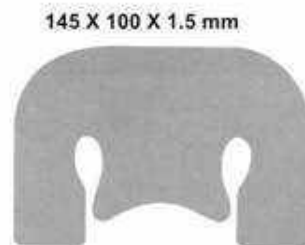

04-6263
Silicon operating pad
pre-cut



04-6264
Polyaethylen splint material
soft-sterile
0.45 mm

Biopsy Currettes

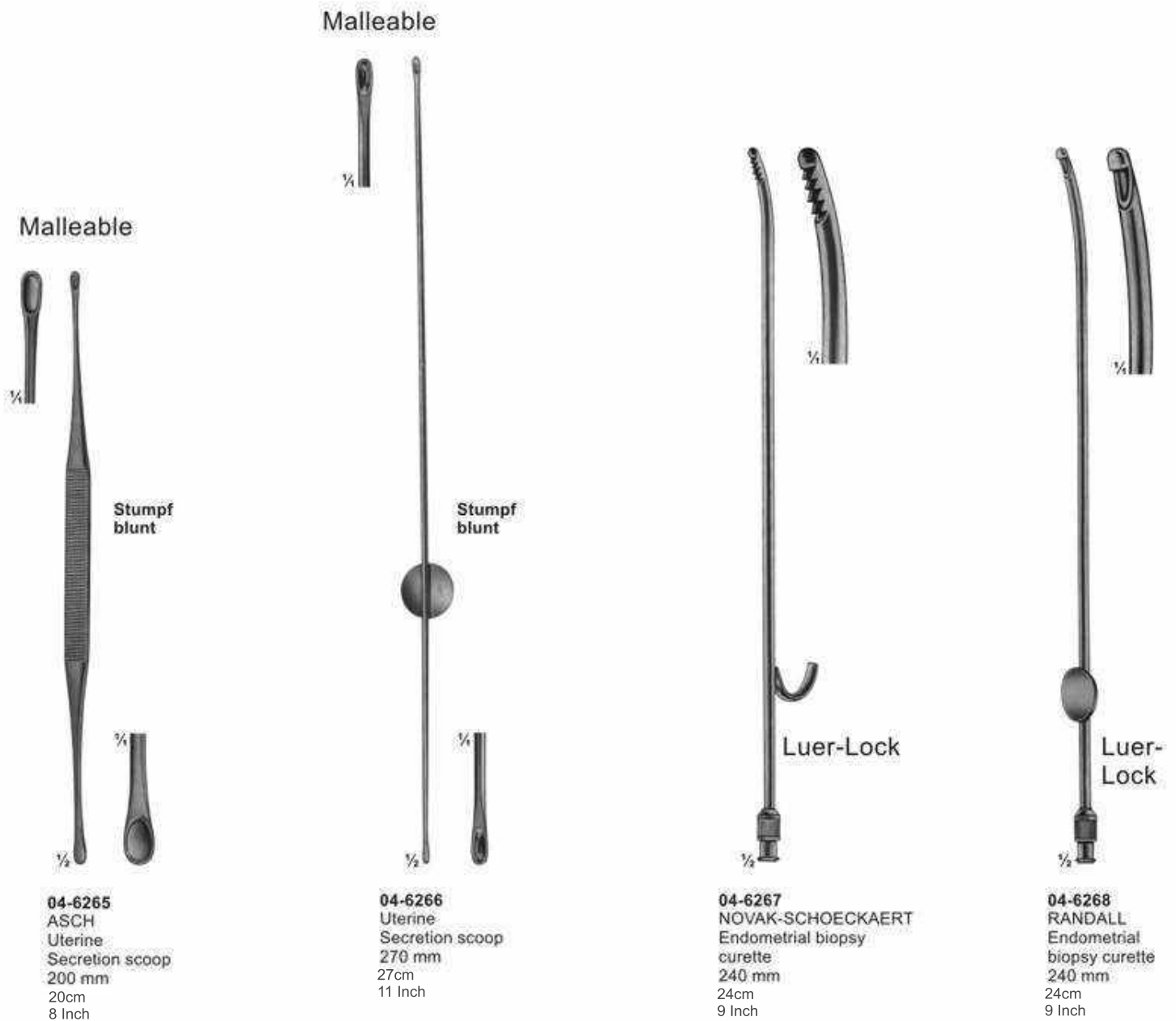

Biopsy Forceps

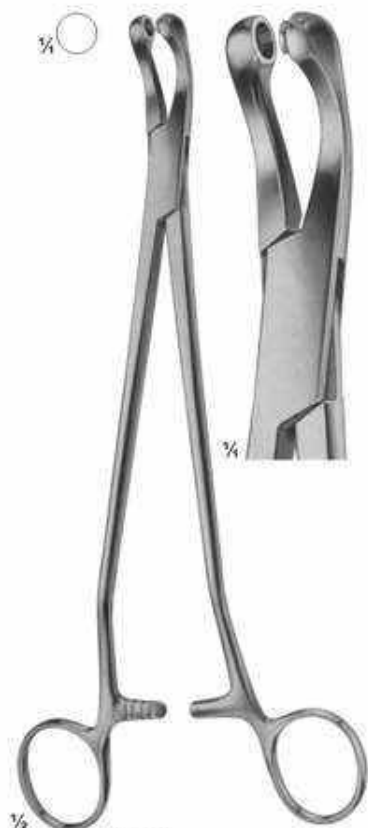

1/2
04-6269
THOMS-GAYLOR
240 mm
24cm
9 Inch



1/2
04-6270
SCHUBERT
260 mm
26cm
10 Inch

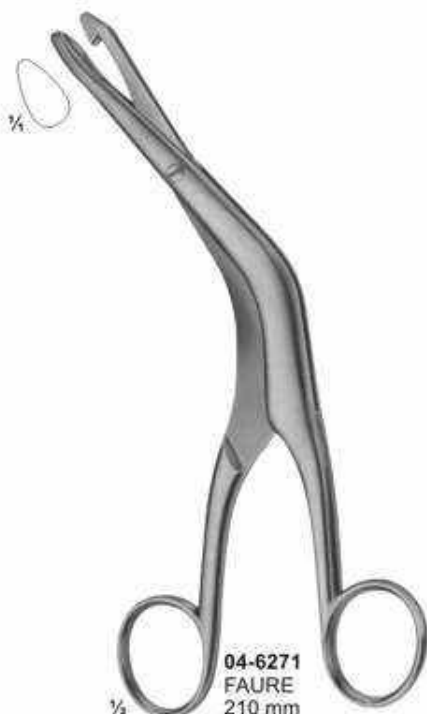

1/2
04-6271
FAURE
210 mm
21cm
8 Inch

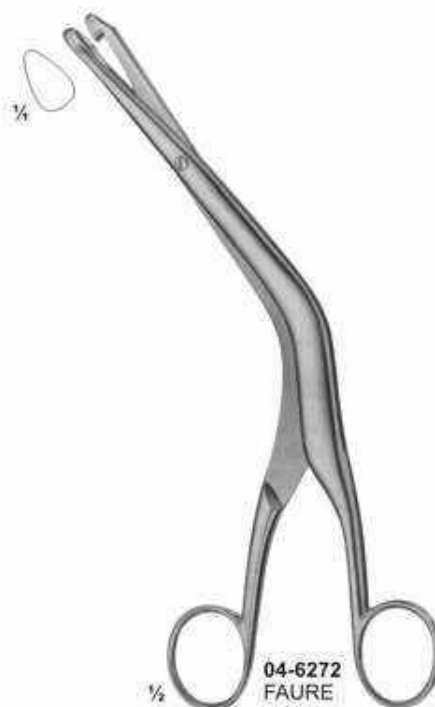

1/2
04-6272
FAURE
240 mm
24cm

Biopsy Forceps

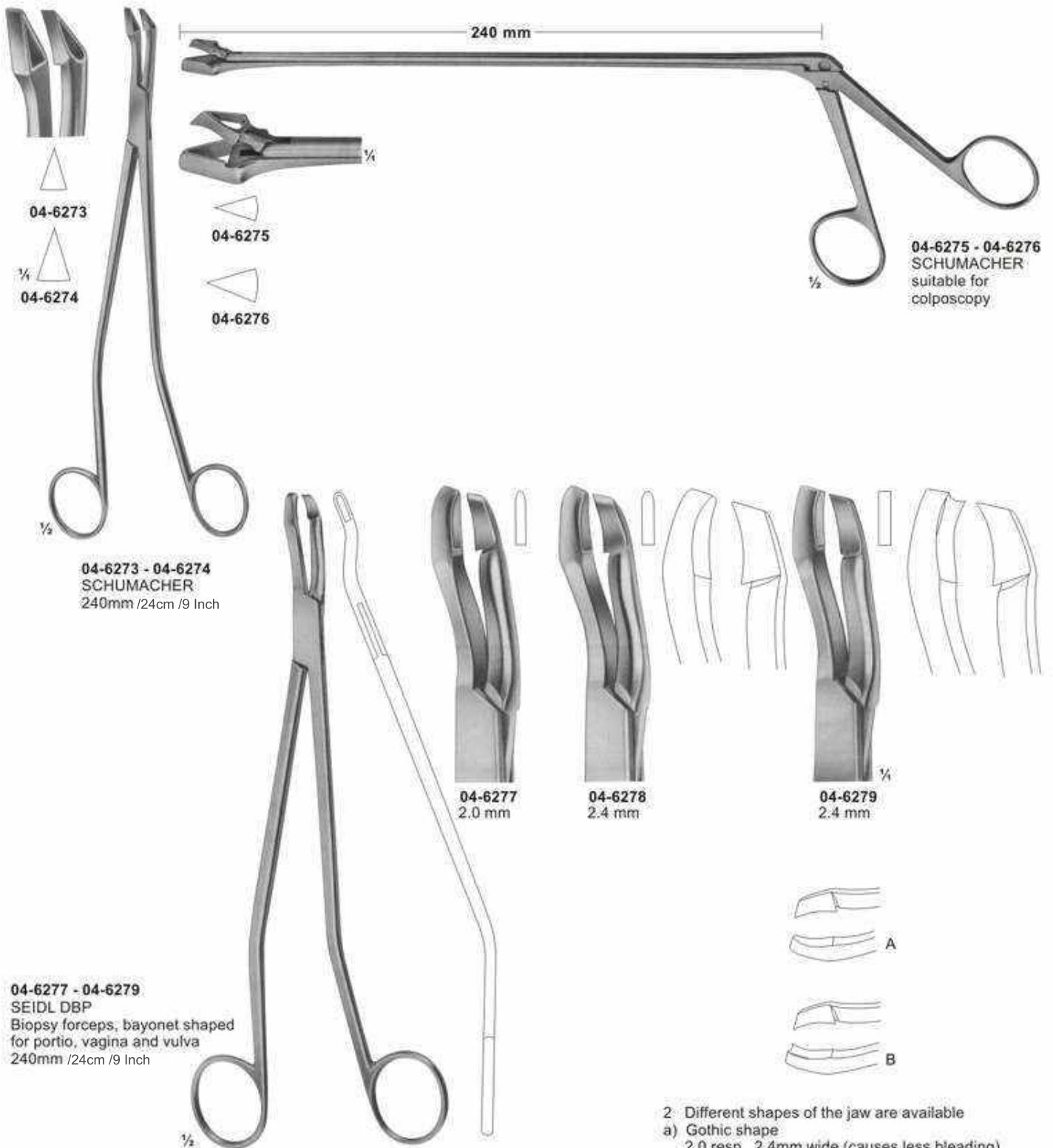

2. Different shapes of the jaw are available
- Gothic shape
2.0 resp. 2.4mm wide (causes less bleeding)
 - Rectangular shape, 2.4mm wide

Biopsy Forceps

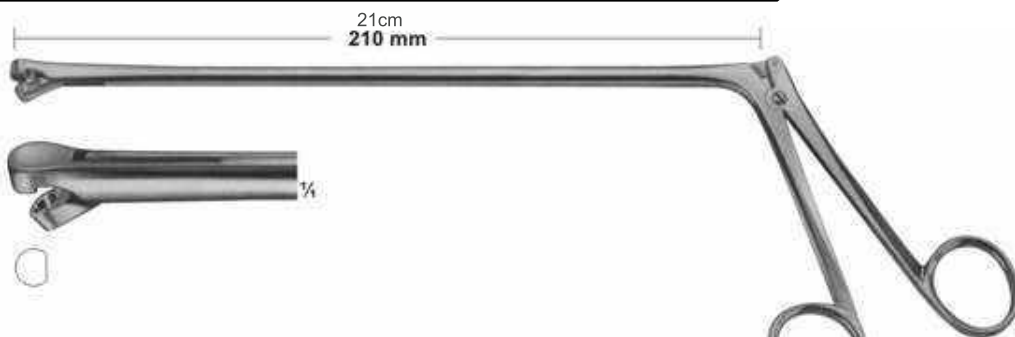

04-6280
BERGER

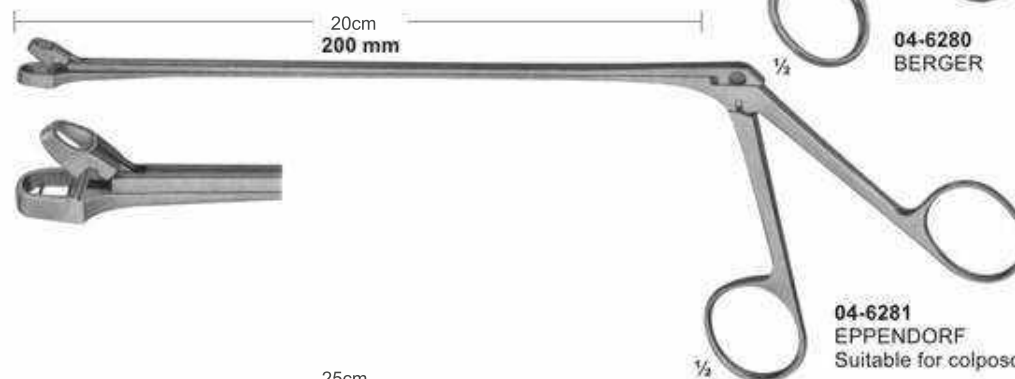

04-6281
EPPENDORF
Suitable for colposcopy

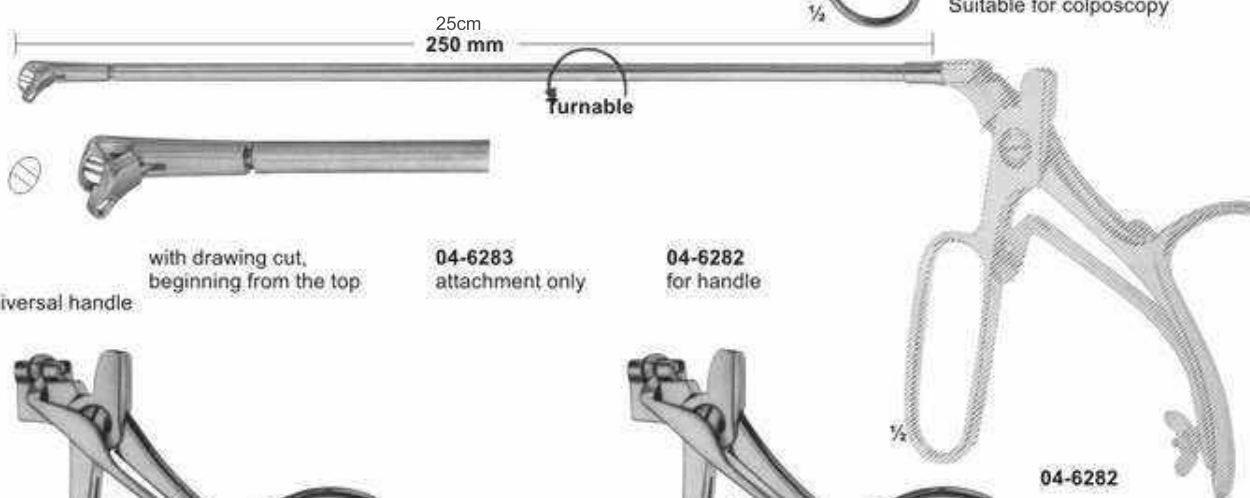

04-6282

universal handle
with drawing cut,
beginning from the top

04-6283
attachment only

04-6282
for handle



04-6282
140 mm / 14cm



04-6284
HUBER
140 mm / 14cm



Extension cannulae

04-6285 BRUENINGS
04-6286 BRUENINGS

200 mm Length / 20cm / 8 Inch
250 mm Length / 25cm / 10 Inch



04-6287 **04-6288**



04-6290 SCHEINMANN (Biopsy tip)



04-6291 SCHUMACHER
(Biopsy tip) with drawing cut

Uterine Scoops

Table of Recamier		Sharp		Blunt	
Fig	Width	Rigid	Malleable	Rigid	
00	4.5mm	04-6294			
0	7.5mm	04-6295		04-6306	
1	8.5mm	04-6296	04-6317	04-6307	
2	10.5mm	04-6297	04-6318	04-6308	
3	12.0mm	04-6298	04-6319	04-6309	
4	14.0mm	04-6299	04-6320	04-6310	
5	15.0mm	04-6300	04-6321	04-6311	
6	16.5mm	04-6301	04-6322	04-6312	
7	18.0mm	04-6302	04-6323	04-6313	
8	19.5mm	04-6303	04-6324	04-6314	
9	21.5mm	04-6304		04-6315	
10	23.5mm	04-6305		04-6316	
04-6294- 04-6305		Sharp - Rigid			
04-6317- 04-6324		Sharp - Malleable			
04-6306- 04-6316		Blunt - Rigid			

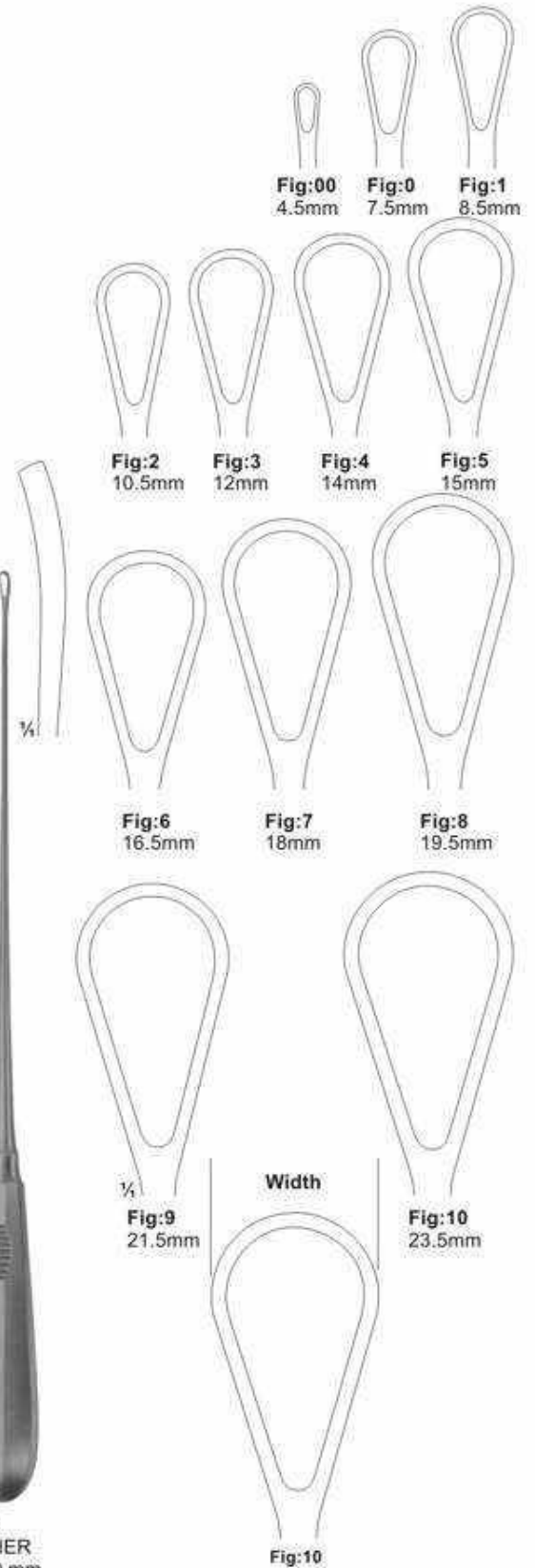
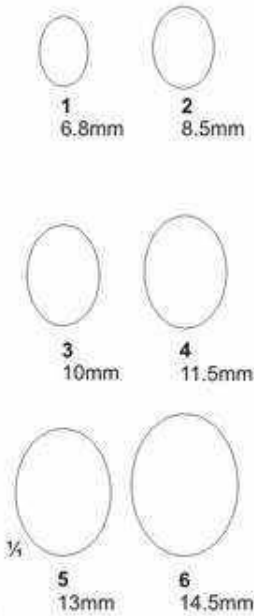
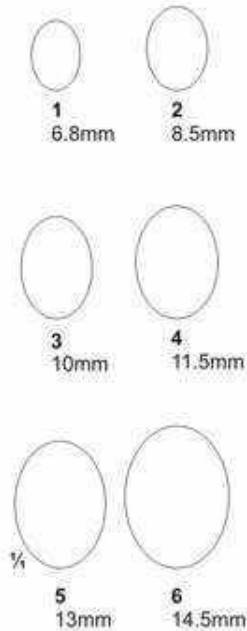

Uterine Curettes

Fig	Width	Sharp		Blunt
		Rigid	Malleable	Rigid
1	7.5mm	04-6325	04-6331	04-6337
2	8.5mm	04-6326	04-6332	04-6338
3	10.5mm	04-6327	04-6333	04-6339
4	12.0mm	04-6328	04-6334	04-6340
5	14.0mm	04-6329	04-6335	04-6341
6	15.0mm	04-6330	04-6336	04-6342

04-6325 - 04-6330 Sharp - Rigid
04-6331 - 04-6336 Sharp - Malleable
04-6337 - 04-6342 Blunt - Rigid

Fig	Width	Blunt - Malleable
0	16.5mm	04-6343
1	18.5mm	04-6344
2	19.5mm	04-6345
3	21.5mm	04-6346
4	23.5mm	04-6347
5	26.0mm	04-6348
6	28.5mm	04-6349

BUMM

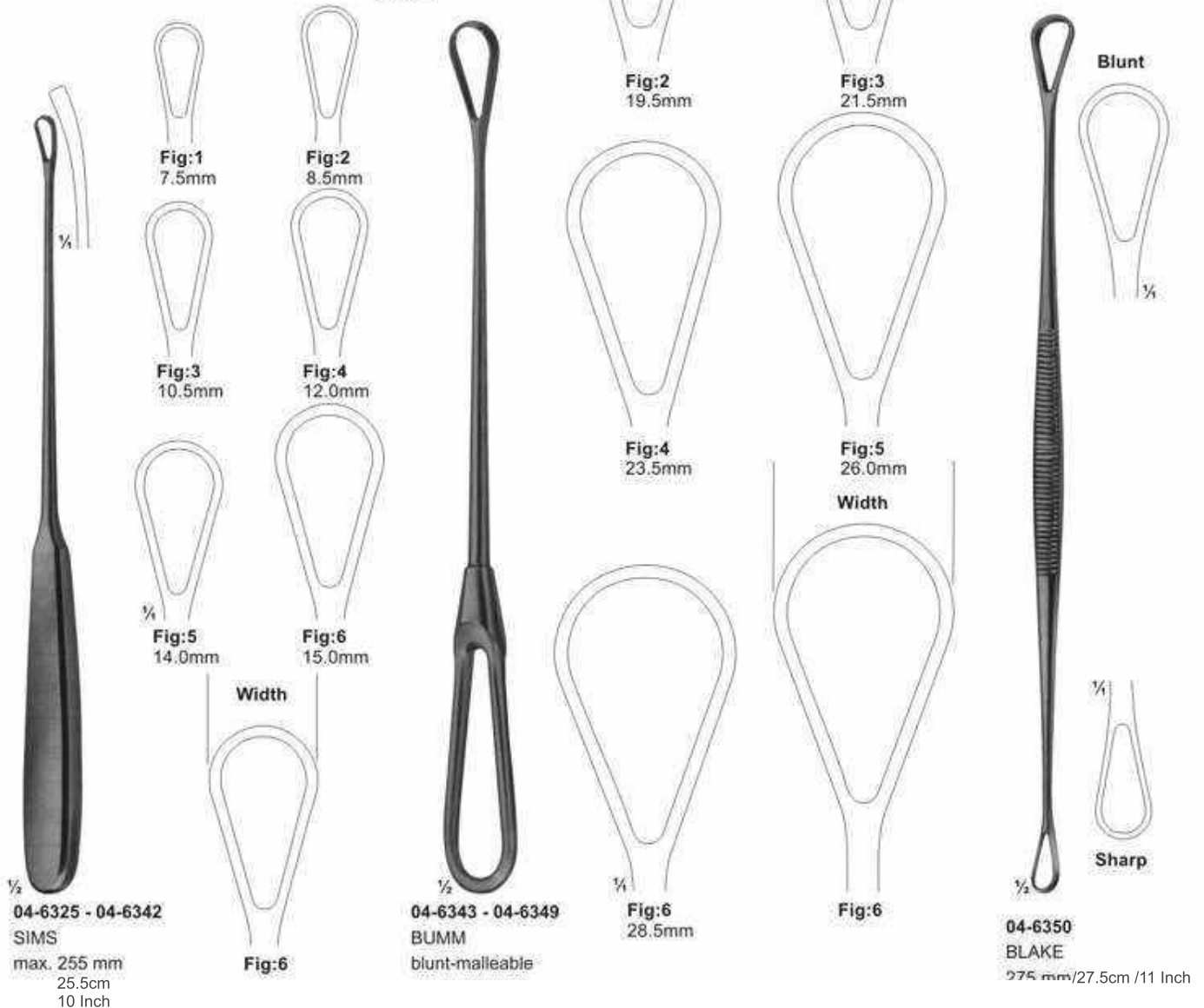

Placenta-and Ovum Curettes

Fig	Width	Sharp Malleable	Blunt Malleable
1	23.5mm	04-6354	04-6356
2	26.0mm		04-6357
3	28.5mm	04-6355	04-6358



04-6351
COLLIN
 300 mm
 30cm
 12 Inch



04-6352 - 04-6353
RECAMIER
 blunt-rigid
 max: 360 mm
 36cm
 14 Inch

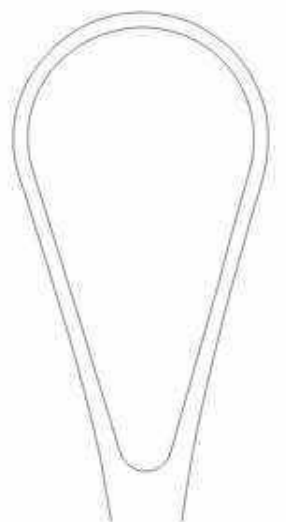

Fig:1

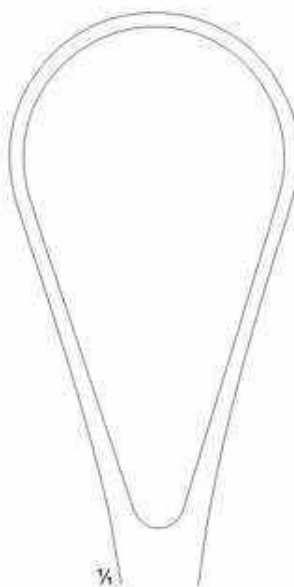

Fig:2



04-6354 - 04-6358
BUMM
 max: 310 mm/31cm /12 Inch



Fig:1



Fig:2



Fig:3

04-6354 - 04-6355 sharp-malleable
04-6356 - 04-6358 blunt-malleable

Vacuum Curettes

04-6359 - 04-6364

Suction curettes, stainless steel, fitting hose connection.

Working tips are smoothly rounded off, therefore no danger of perforation.



(suitable for suction biopsy)

04-6359: diam 4 mm

04-6360: diam 6 mm

04-6361: diam 8 mm

04-6362: diam 10 mm

04-6363: diam 12 mm

04-6364: diam 14 mm

04-6365

Hose connection inside diam. 11 mm, curved, stainless steel.



The new connection between suction curette and hose connection, (04-6365) Guarantees quick changing and free turning of the suction curettes on the hose connection.

04-6366

Transparent suction hose 1.8 mm long, inside diam 11 mm, outside diam 16.5 mm can be sterilized in an autoclave at 1 bar overpressure (120°C)

04-6367

Strainer for tissues, plastic, for single use only, to be used for histopathological examination.



Gynaecological Instruments



04-6368 diam 8 mm
04-6369 diam 10 mm
BOZEMANN-FRITSCH
Uterine Flushing Tube
350 mm /35cm /14 Inch

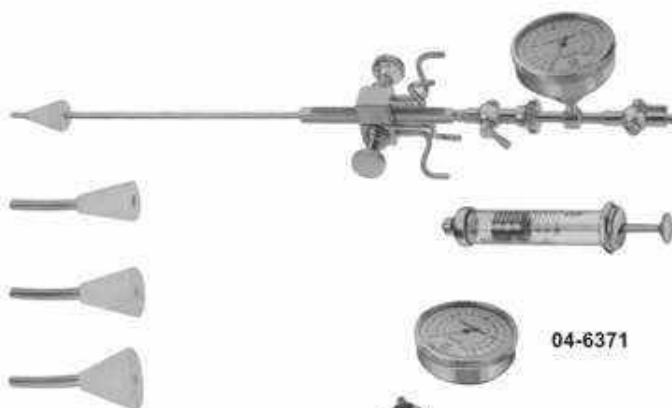

04-6370
SCHULZE
Salpingograph, for utero-salpingography
in wooden case, consisting of:
04-6371 Manometer only
04-6372 Connection only, without manometer
04-6373 Uterine cannula with tape without cone
04-6374 Cone only, small
04-6375 Cone only, medium
04-6376 Cone only, large
04-6377 Record syringe, 10CC, luer-lock mount.

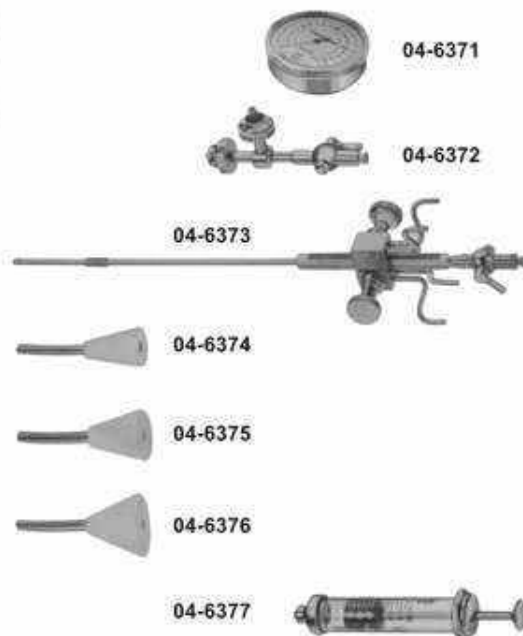

04-6378
SCHULZE
Salpingograph, equipment like(04-6370)
but without manometer.



Obstetrics-Pelvimeters



04-6379
THOLE
 for internal and external measurements, graduated in centimeters



04-6380
DE LEE
 graduated in centimeters and inches



04-6381
COLLIN
 graduated in centimeters



04-6382
MARTIN
 graduated in centimeters



04-6383
SCHNEIDER
 graduated in centimeters

The additional straight arm can be replaced. The pelvimeter with straight arm is used for localisation of the portio vaginalis uteri and of vaginal metastasis.



04-6384
BREISKY
 graduated in centimeters

Forceps For Obstetrics



04-6385
 HERFF
 membrane puncturing
 forceps
 255 mm /25.5cm /10 Inch



04-6386
 IOWA
 membrane puncturing
 forceps
 260 mm /26cm /10 Inch

Scissors of Obstetrics, Umbilical cord clamp



04-6387
SCHUMACHER
Umbilical cord
scissors
155 mm
15.5cm
6 Inch



04-6388
Umbilical cord
scissors
105 mm
10.5cm
4 Inch

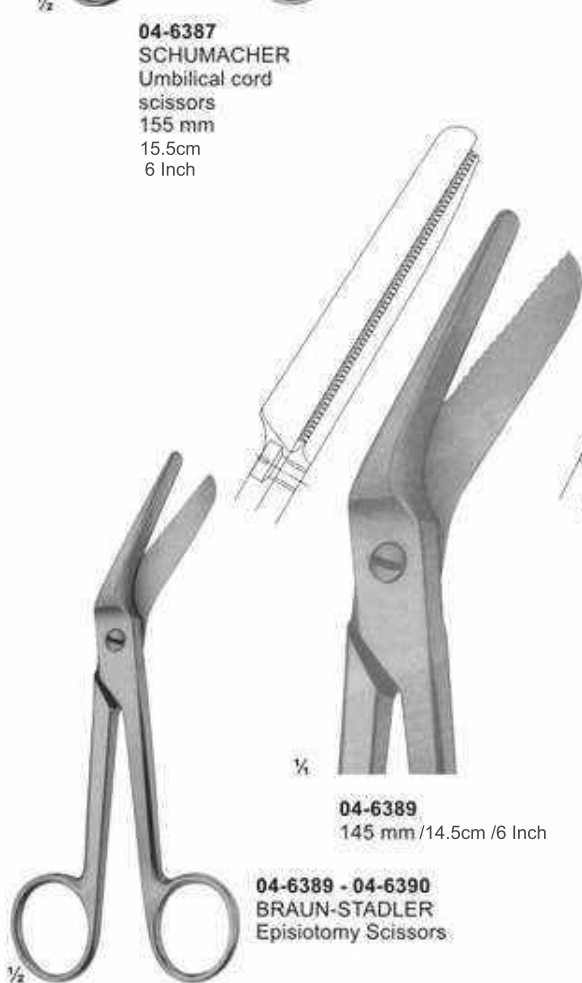

04-6389
145 mm /14.5cm /6 Inch

04-6389 - 04-6390
BRAUN-STADLER
Episiotomy Scissors.

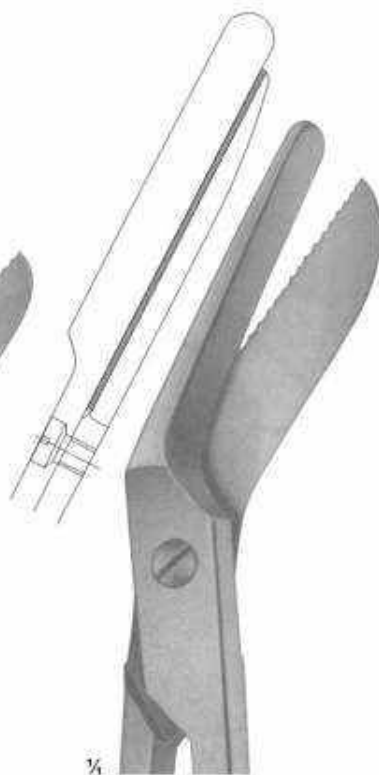

04-6390
200 mm
20cm
8 Inch

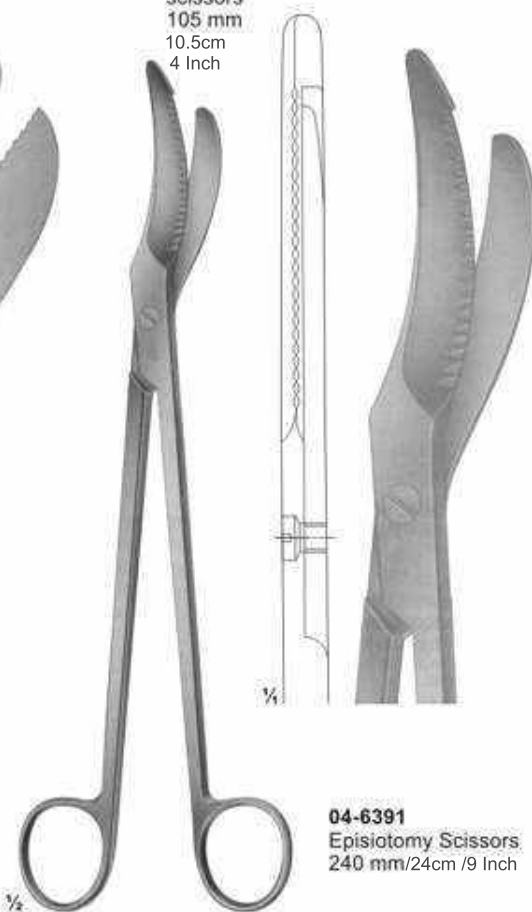

04-6391
Episiotomy Scissors
240 mm/24cm /9 Inch

Obstetrics - Obstetrical Forceps



04-6392
NAEGELE
355 mm
35.5cm
13 Inch



04-6393
NAEGELE
400 mm
40cm
15 Inch



04-6394
SIMPSON-BRAUN
305mm
30.5cm
12 Inch

Obstetrics - Obstetrical Forceps



04-6395
SIMPSON-BRAUN
 350mm
 35cm
 14 Inch

For caesarean section



04-6396
SIMPSON
 235mm
 23.5cm
 13 Inch

For caesarean section

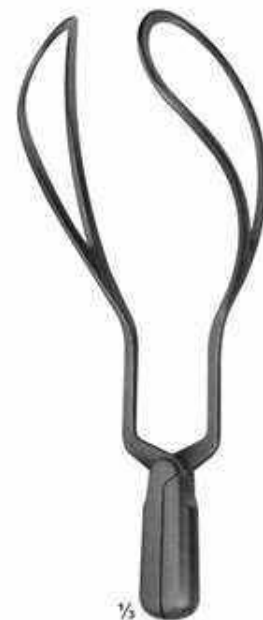

04-6397
WRIGLEY
 250 mm
 25cm
 10 Inch

Obstetrics Forceps



04-6398
GREEN-ARMYTAGE
 Caesarean section haemostatic
 forceps, for edges of the transverse
 incision in the lower segment
 220 mm /22cm /9 Inch



04-6399
WILLETTS
 Scalp Flap forceps
 185 mm
 18.5cm
 7 Inch



04-6400
GAUSS
 Scalp Flap forceps
 260 mm
 26cm
 10 Inch

Obstetrics-Placenta and Ovum Forceps

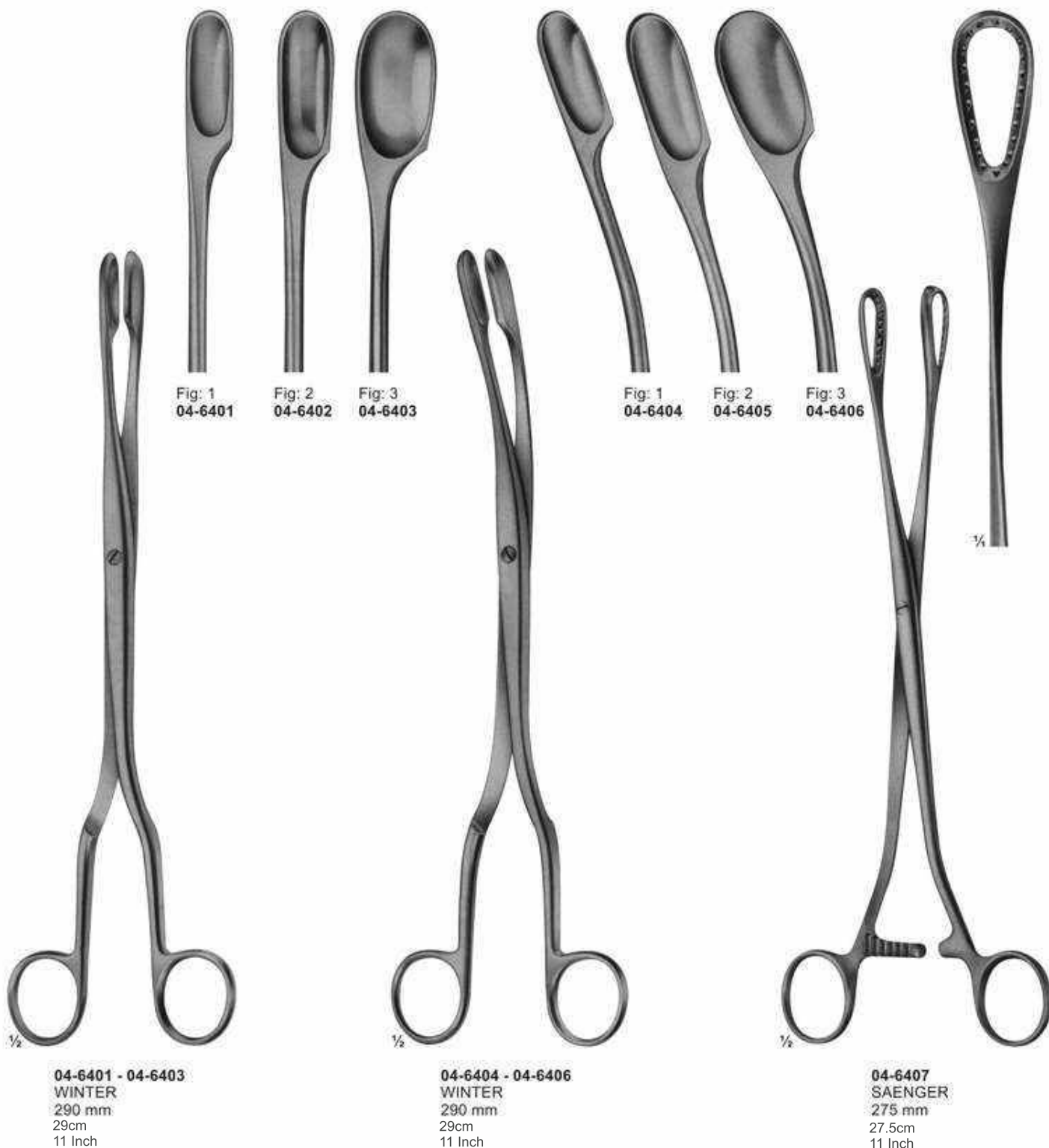

04-6401 - 04-6403
 WINTER
 290 mm
 29cm
 11 Inch

04-6404 - 04-6406
 WINTER
 290 mm
 29cm
 11 Inch

04-6407
 SAENGER
 275 mm
 27.5cm
 11 Inch

Obstetrics-Placenta and Ovum Forceps



04-6408
SAENGER
 285 mm
 11.5cm
 11 Inch

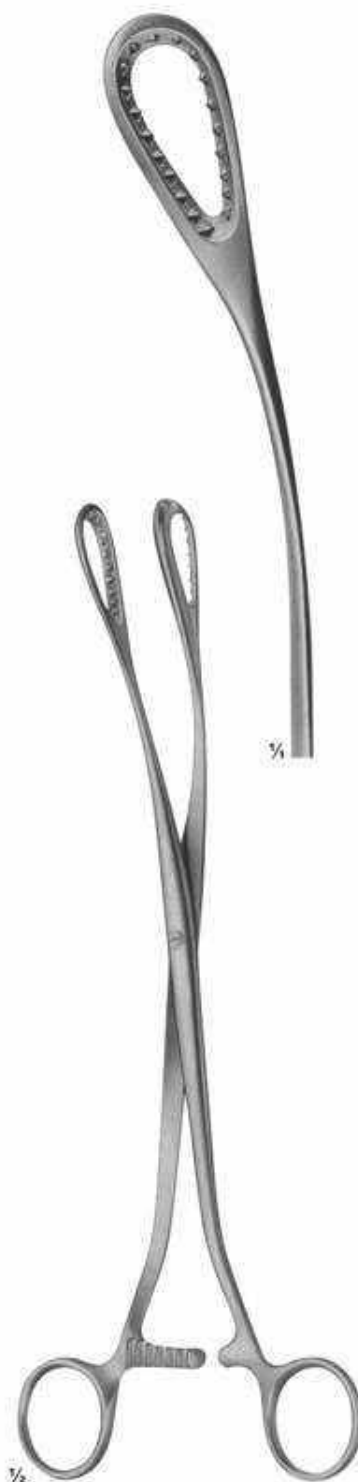

04-6409
SAENGER
 265 mm
 26.5cm
 10 Inch



04-6410

04-6411



04-6410 - 04-6411
LEWKOWITZ
 245 mm
 24.5cm
 10 Inch

**Obstetrics-Placenta and Ovum Forceps,
 Perforator, Cranioclast**



04-6412
KELLY
 320mm
 32cm
 12 Inch



04-6413
SPELLIE
 Perforator
 270mm
 27cm
 11 Inch

1 jaws fenestrated



04-6414
BRAUN
 Cranioclast
 420mm
 42cm
 17 Inch

Section - 05



DENTELO SURGICAL[®]
INTERNATIONAL
Serving World of Surgical Since 1996.



Pages 265-327

Pages 255-318

- ★ Tracheotomy, Cardiovascular & Thoracic Surgery
- ★ Bone Punches & Rongeurs

Tracheal Tubes with inner tubes

Fig.	0	1	2	3	4	5	6	7	8	9	10
∅ mm	4	5	6	7	8	9	10	11	12	13	14
Charr./Fr.	12	15	18	21	24	27	30	33	36	39	42



½

05-7001
UECKERMANN-DENKER
Cryothyrotomy trocar
with silver cannula
130mm /13cm /5 Inch

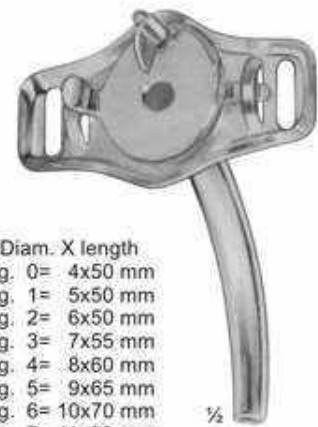

½

Diam. X length
05-7002 Fig. 0= 4x50 mm
05-7003 Fig. 1= 5x50 mm
05-7004 Fig. 2= 6x50 mm
05-7005 Fig. 3= 7x55 mm
05-7006 Fig. 4= 8x60 mm
05-7007 Fig. 5= 9x65 mm
05-7008 Fig. 6= 10x70 mm
05-7009 Fig. 7= 11x80 mm
05-7010 Fig. 8= 12x85 mm
05-7011 Fig. 9= 13x90 mm
05-7012 Fig. 10=14x90 mm

05-7002 - 05-7012
LUER
German silver



½

05-7013 - 05-7022
JACKSON
German Silver

Diam. X length
05-7013 Fig. 0= 4x50 mm
05-7014 Fig. 1= 5x48 mm
05-7015 Fig. 2= 6x58 mm
05-7016 Fig. 3= 7x70 mm
05-7017 Fig. 4= 8x78 mm
05-7018 Fig. 5= 9x84 mm
05-7019 Fig. 6= 10x84 mm
05-7020 Fig. 7= 11x86 mm
05-7021 Fig. 8= 12x88 mm
05-7022 Fig. 9= 13x90 mm



½

Diam. X length **05-7023 - 05-7032**
05-7023 Fig. 1= 5x48 mm **JACKSON**
05-7024 Fig. 2= 6x58 mm **Stainless Steel**
05-7025 Fig. 3= 7x70 mm
05-7026 Fig. 4= 8x78 mm
05-7027 Fig. 5= 9x84 mm
05-7028 Fig. 6= 10x84 mm
05-7029 Fig. 7= 11x86 mm
05-7030 Fig. 8= 12x88 mm
05-7031 Fig. 9= 13x90 mm
05-7032 Fig. 10= 14x90 mm



Wound-and Tracheal Hooks and Dilators



05-7033
BOSE
 165 mm
 16.5cm
 6 Inch



05-7034
BOSE
 165 mm
 16.5cm
 6 Inch



05-7035
 sharp



05-7036
 blunt



05-7037
 blunt

05-7035 - 05-7037
 180 mm
 18cm
 7 Inch



05-7038
FINSEN
 50 mm
 5cm



05-7039
FINSEN
 70 mm
 7cm



05-7040
TROUSSEAU
 120 mm
 12cm
 5 Inch



05-7041
LABORDE
 125 mm
 12.5cm
 5 Inch



05-7042
LABORDE
 strong pattern
 135 mm
 13.5cm
 5 Inch



05-7043
 Cleaning Brush
 for tracheal tubes
 285 mm/28.5cm /11 Inch

**Irrigating Cannulae, Embolus Grasping
 Forceps, Dilators**



Luer Lock

05-7044 - 05-7047
 SCHMID
 Vessel irrigating cannulae,
 malleable, silver plated
 150 mm
 15cm
 6 Inch



05-7048
 BLAKE
 Embolus grasping
 forceps
 205 mm
 20.5cm
 8 Inch

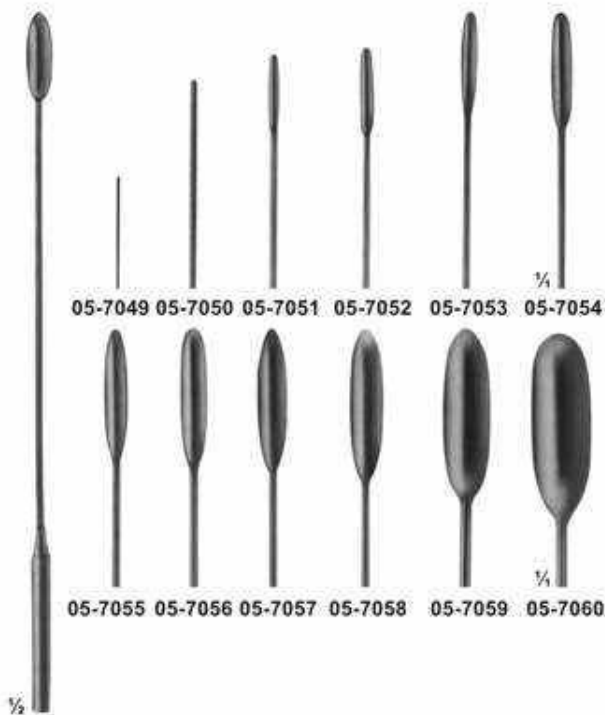

05-7049 - 05-7060
 DE BAKY
 Vascular dilators,
 malleable
 190 mm
 19cm
 7 Inch

05-7049	0,5 mm Ø	05-7055	3,5 mm Ø
05-7050	1,0 mm Ø	05-7056	4,0 mm Ø
05-7051	1,5 mm Ø	05-7057	4,5 mm Ø
05-7052	2,0 mm Ø	05-7058	5,0 mm Ø
05-7053	2,5 mm Ø	05-7059	7,0 mm Ø
05-7054	3,0 mm Ø	05-7060	9,0 mm Ø

Vascular Spatulas

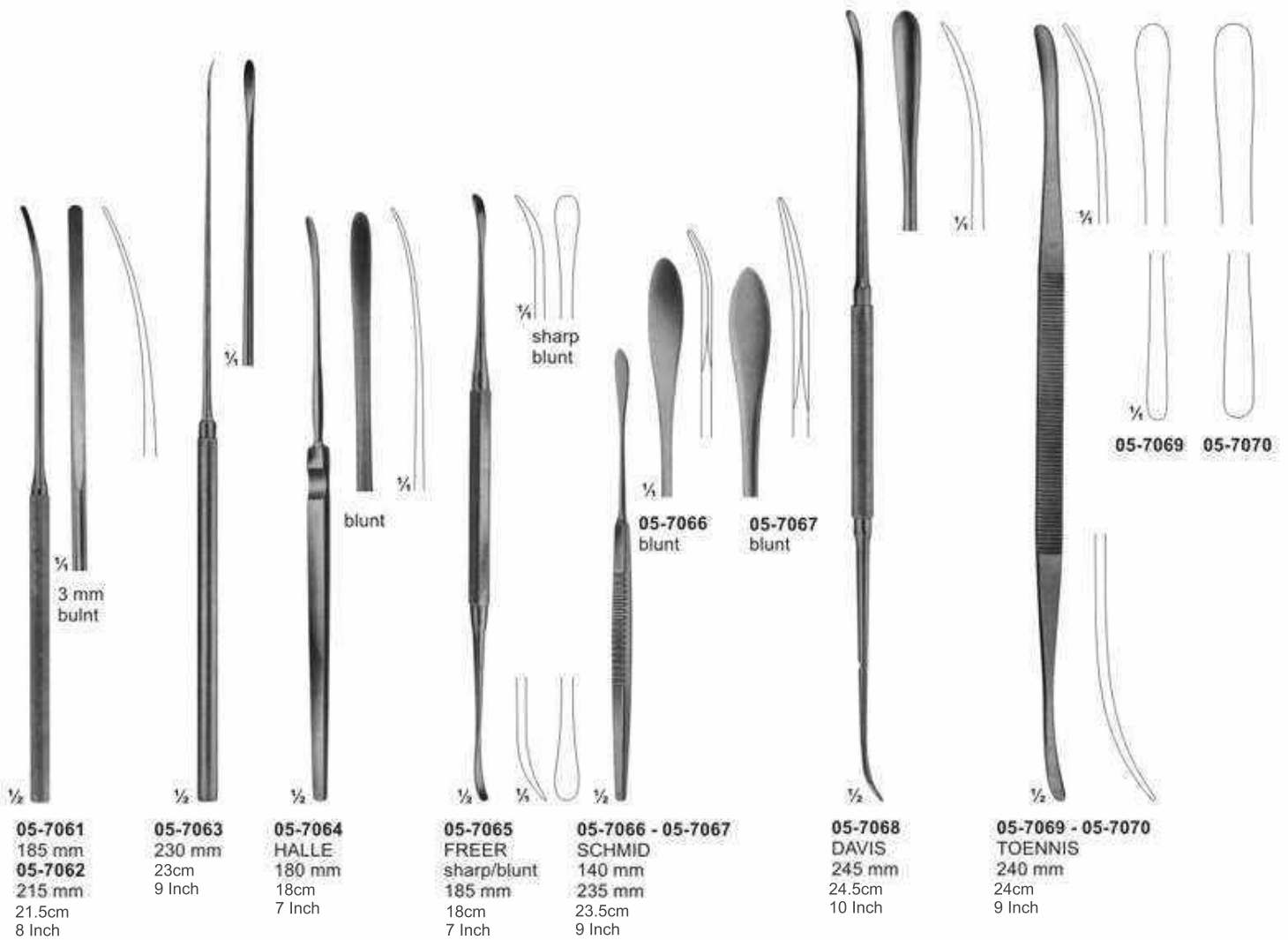

Endarterectomy Strippers, Tourniquets

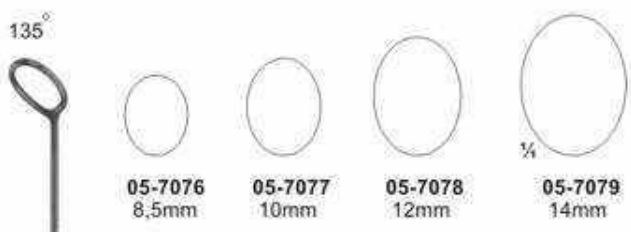
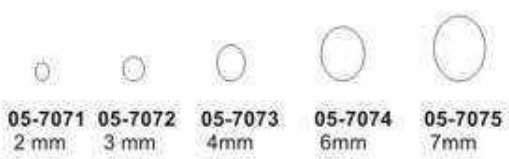

05-7071 - 05-7079
 Endarterectomy strippers
 550 mm /55cm /22 Inch



05-7080
 Handle for
 110 mm
 11cm
 4 Inch



05-7081 - 05-7082 **05-7083 - 05-7084**
 RUMEL-BELMONT Guide only
 325 mm/32.5cm /12 Inch
 05-7081 - 4,0 mm Ø
 05-7082 - 6,4 mm Ø

Bioptome and Aortic Dilators

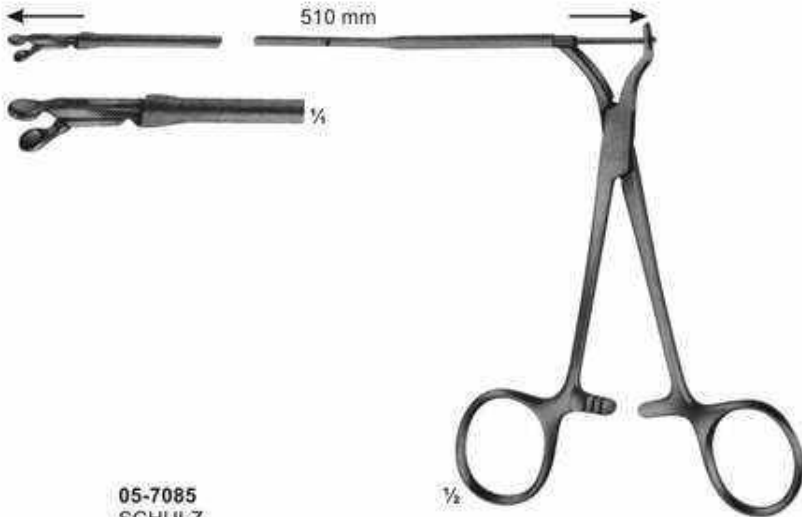

05-7085
SCHULZ

Bioptome, with flexible Shaft, 510 mm long,
 with round jaws 3 mm diam.

Biopsy forceps, for biopsy from the right atrium
 through cava jugularis, prior to heart implantations.

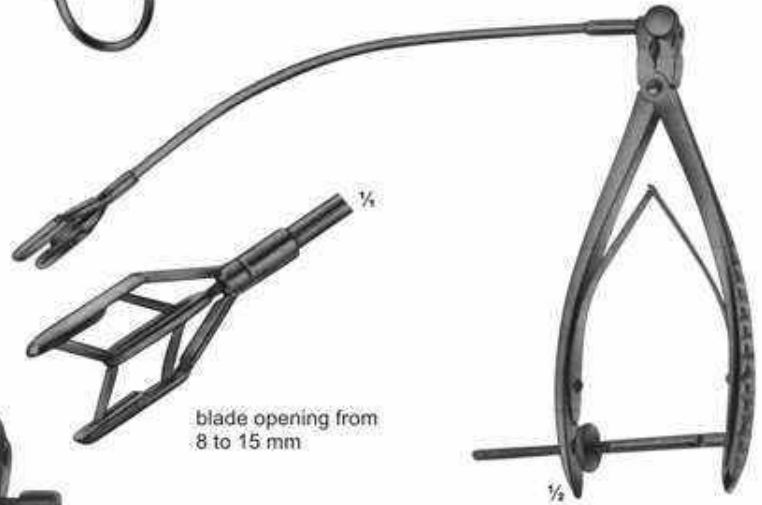

05-7087
COOLEY
 Dilator for
 mitral valve
 for children

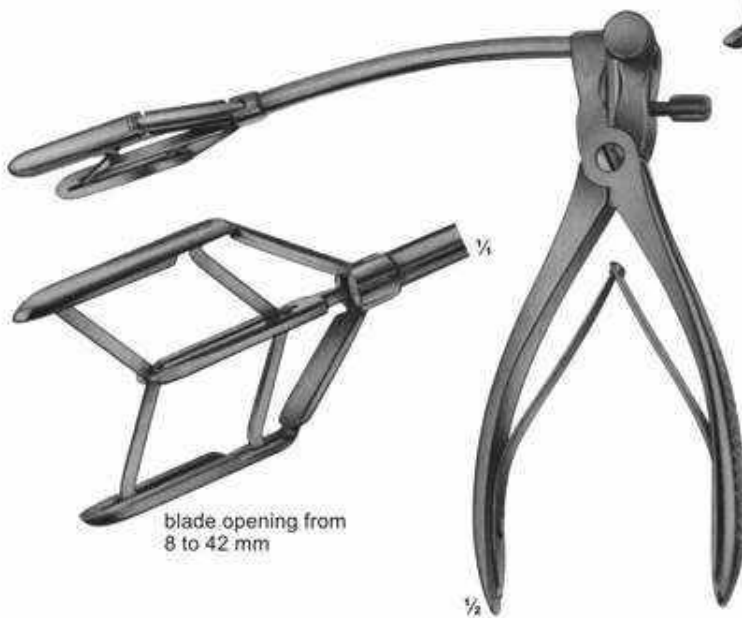

blade opening from
 8 to 42 mm

blade opening from
 8 to 15 mm

05-7086
TUBBS
 Dilator for
 mitral valve

JENKER Instrument Set For Tunnelling And Pulling-Through Vascular Grafts Toothings

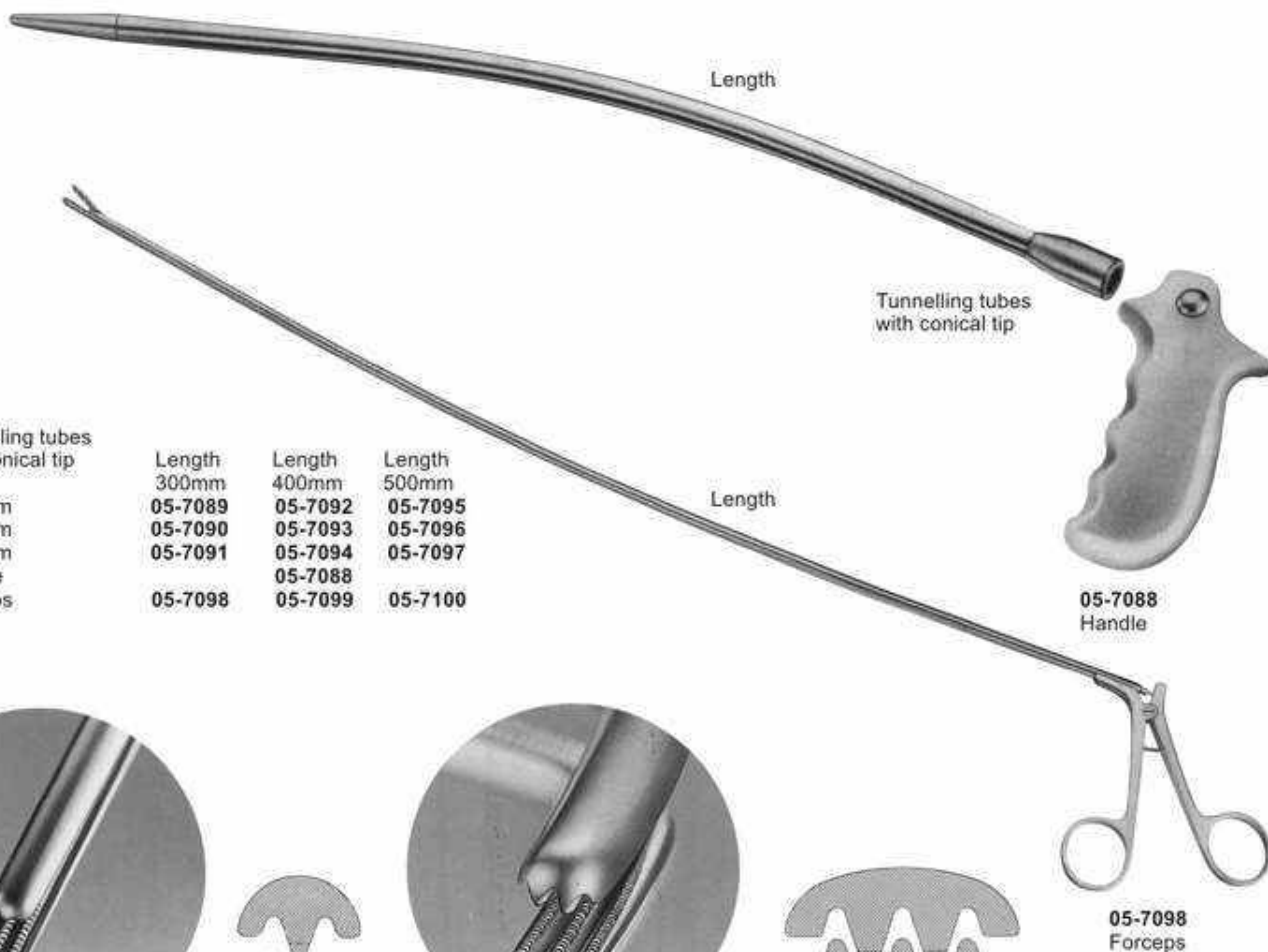

Tunnelling tubes with conical tip

	Length 300mm	Length 400mm	Length 500mm
∅ 12mm	05-7089	05-7092	05-7095
∅ 14mm	05-7090	05-7093	05-7096
∅ 17mm	05-7091	05-7094	05-7097
Handle	05-7098	05-7088	
Forceps		05-7099	05-7100

05-7088
Handle

05-7098
Forceps



DE BAKEY

05-7101
1 : 2 rows of teeth.

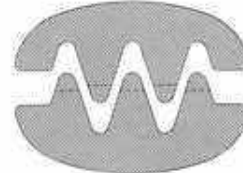

DE BAKEY

05-7102
2 : 3 rows of teeth

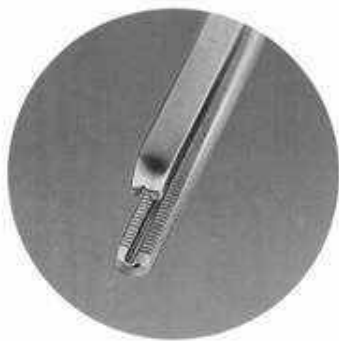

COOLEY

05-7103
2 : 2 rows of teeth

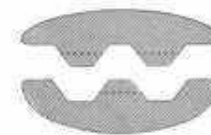
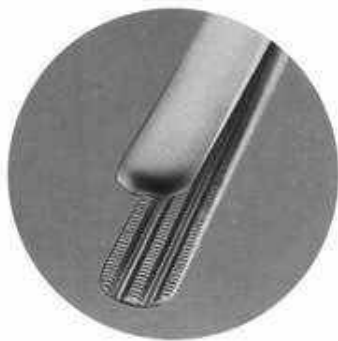

DARDIK

05-7104
2 : 3 rows of teeth

Atraumata Ultra-Light-Forceps



05-7105
 Width of jaws 1.2 mm
 Length 150mm /15cm /6 Inch



05-7106
 Width 1.5 mm
 Length 200 mm/20cm /8 Inch



05-7107
 Width 1.5 mm
 Length 240 mm/24cm /9 Inch



05-7108
 Width 1.5 mm
 Length 300 mm
 30cm
 12 Inch

Atraumata Dissecting Forceps

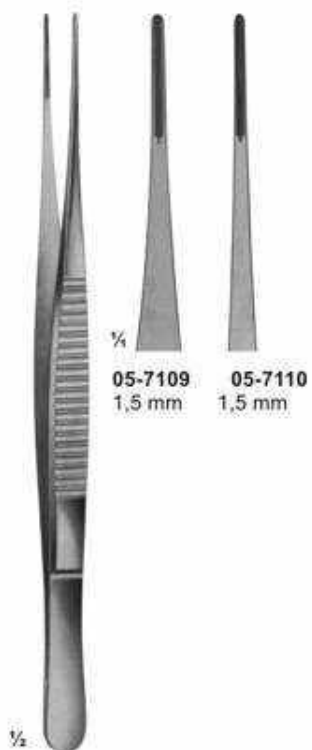

1/4
05-7109 **05-7110**
 1,5 mm 1,5 mm

05-7109 - 05-7110
 DE BAKEY
 150 mm 15cm
 300 mm 30cm

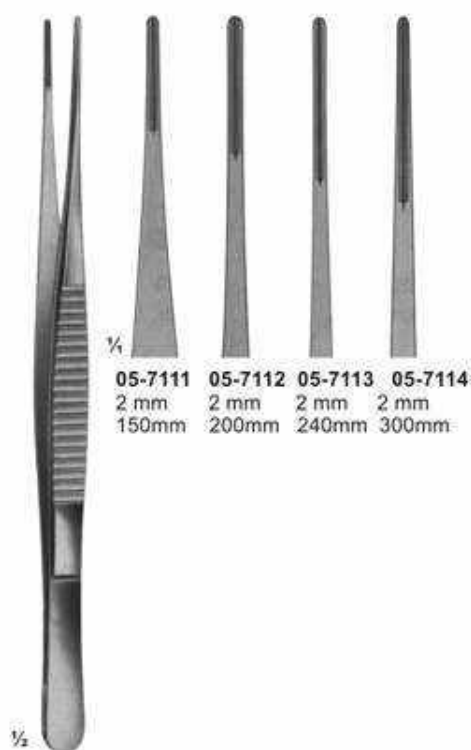

1/4
05-7111 **05-7112** **05-7113** **05-7114**
 2 mm 2 mm 2 mm 2 mm
 150mm 200mm 240mm 300mm

05-7111 - 05-7114
 DE BAKEY

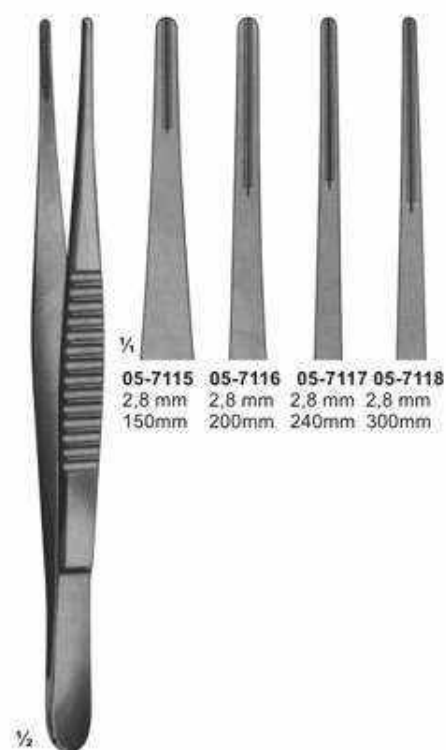

1/4
05-7115 **05-7116** **05-7117** **05-7118**
 2,8 mm 2,8 mm 2,8 mm 2,8 mm
 150mm 200mm 240mm 300mm

05-7115 - 05-7118
 DE BAKEY



1/4
05-7119 **05-7120**
 3,3mm 3,5 mm
 200mm 300mm

05-7121
 3,5 mm
 240mm
 24cm
 9 Inch

05-7119 - 05-7121
 DE BAKEY

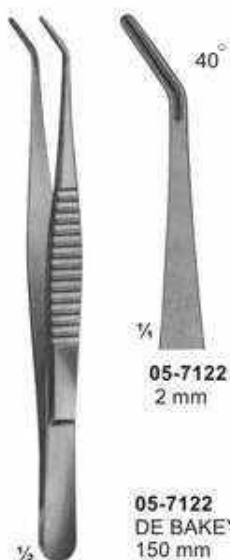

1/4
05-7122
 2 mm

05-7122
 DE BAKEY
 150 mm
 15cm
 6 Inch

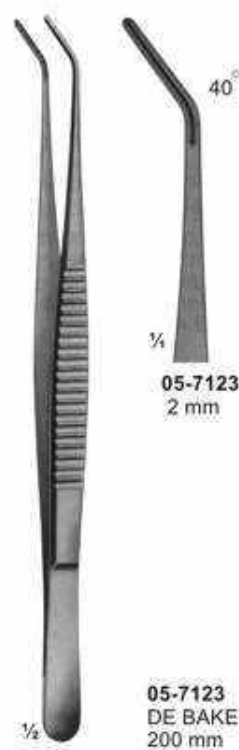

1/4
05-7123
 2 mm

05-7123
 DE BAKEY
 200 mm
 20cm
 8 Inch

Atraumata Ring Handle Bulldog Clamps

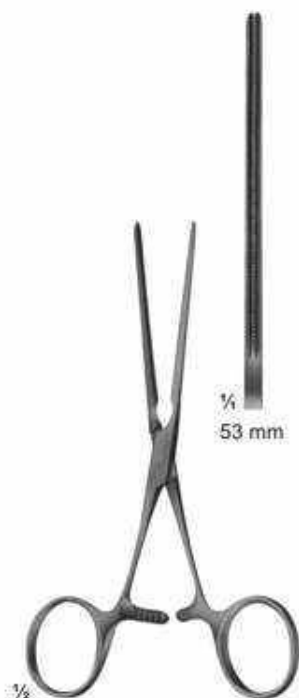

05-7124
DE-BAKEY
straight
130 mm
13cm
5 Inch



05-7125
DE-BAKEY
curved jaws
125 mm
12.5cm
5 Inch

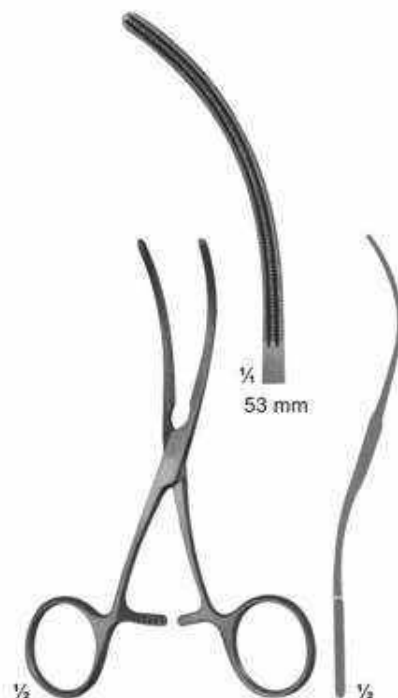

05-7126
DE-BAKEY
S-shaped curved
125 mm
12.5cm
5 Inch

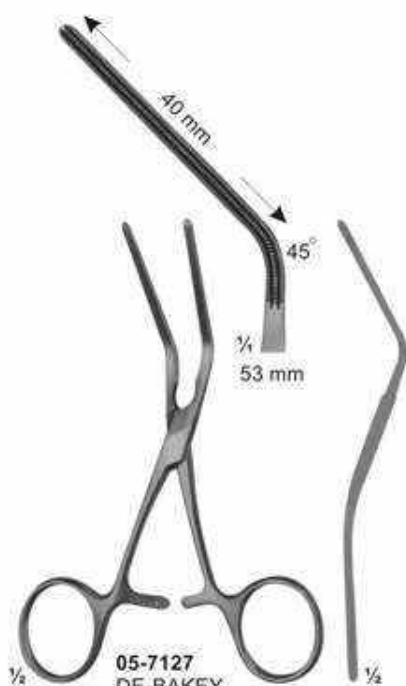

05-7127
DE-BAKEY
angled 45
125 mm
12.5cm
5 Inch



05-7128
DE-BAKEY
angled 90
105 mm
10.5cm
4 Inch

Atraumata Anastomosis and Multi-Purpose-Clamps for Neonatales

graduated



05-7129 - 05-7132
 CASTANEDA



05-7129
 Length 105 mm
 10.5cm
 4 Inch



05-7130
 Length 120 mm
 12cm
 5 Inch



05-7131
 Length 120 mm
 12cm
 5 Inch



05-7132
 Length 125 mm
 12.5cm
 5 Inch

graduated



05-7133 - 05-7136
 CASTANEDA



05-7133
 Length 155 mm
 15.5cm
 6 Inch



05-7134
 Length 155 mm
 15.5cm
 6 Inch



05-7135
 Length 155 mm
 15.5cm
 6 Inch



05-7136
 Length 155 mm
 15.5cm
 6 Inch

Atraumata Anastomosis-and Multi-Purpose Clamps-Pediatric types

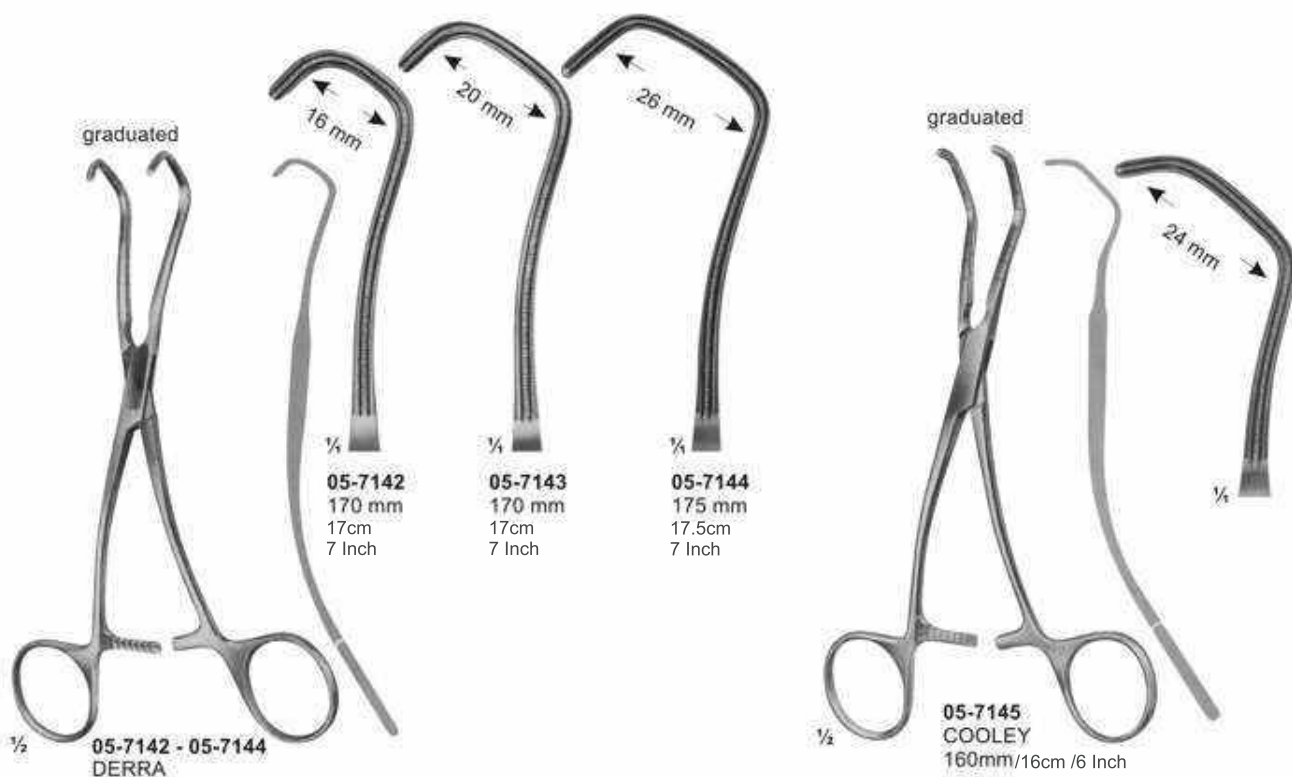
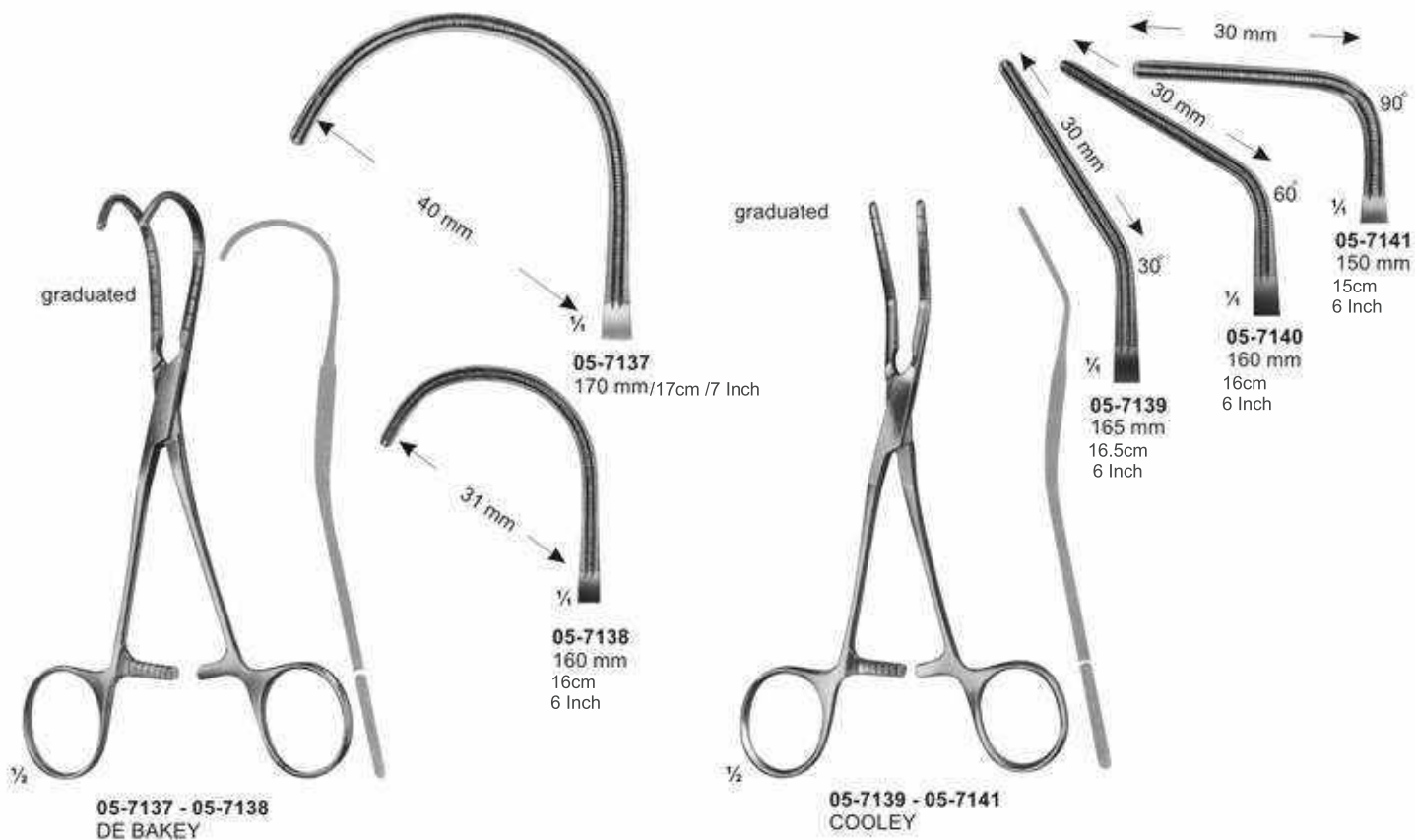

Atraumata Non-traumatic Haemostatic Forceps

Mosquito Forceps



05-7146
20 mm

05-7147
20 mm

05-7146 - 05-7147
125 mm
12.5cm
5 Inch



05-7148
27 mm

05-7149
27 mm

05-7148 - 05-7149
165 mm
16.5cm
6 Inch



05-7150
40 mm

05-7151
40 mm

05-7150 - 05-7151
DE BAKEY-BAINBRIDGE
155 mm
15.5cm
6 Inch



05-7152
65 mm

05-7153
65 mm

05-7152 - 05-7153
DE BAKEY-BAINBRIDGE
180 mm
18cm
7 Inch

Atraumata Non-traumatic Haemostatic Forcep



05-7154 - 05-7155
 DE-BAKEY-KELLY
 140 mm

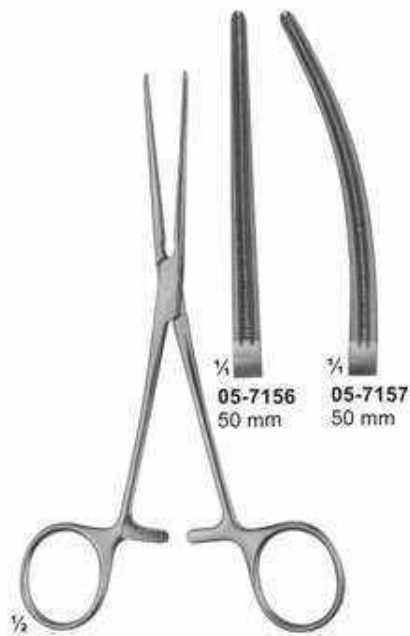

05-7156 - 05-7157
 PEAN
 155 mm

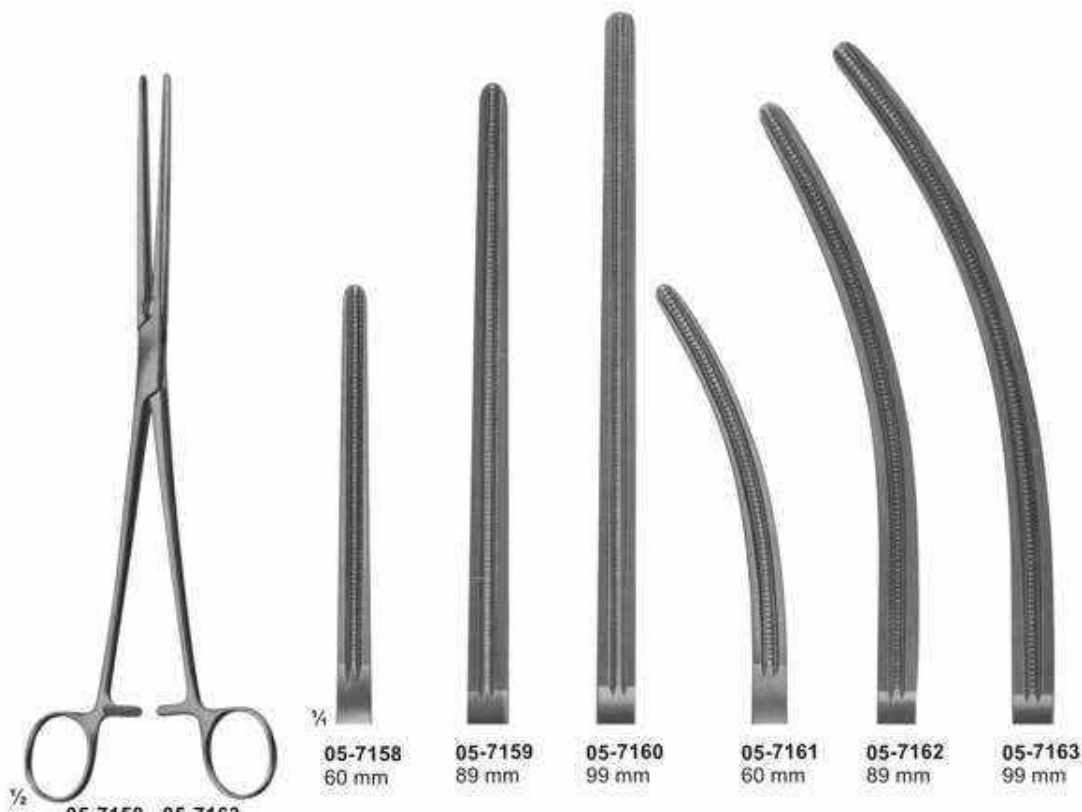

05-7158 - 05-7163
 DE-BAKEY-PEAN DE-BAKEY-PEAN

05-7158 200 mm	05-7161 200 mm /20cm /8 Inch
05-7159 265 mm	05-7162 260 mm /26cm /10 Inch
05-7160 280 mm	05-7163 275 mm /27.5cm /11 Inch

Atraumata Dissecting And Ligature Forceps Anastomosis Clamps

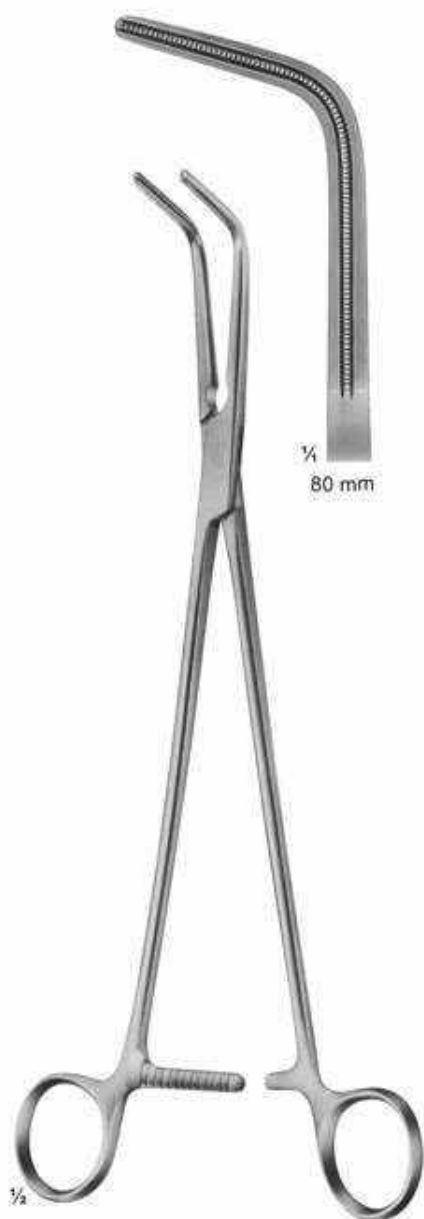

05-7164
DE-BAKEY-MIXTER
285 mm
28.5cm
11 Inch

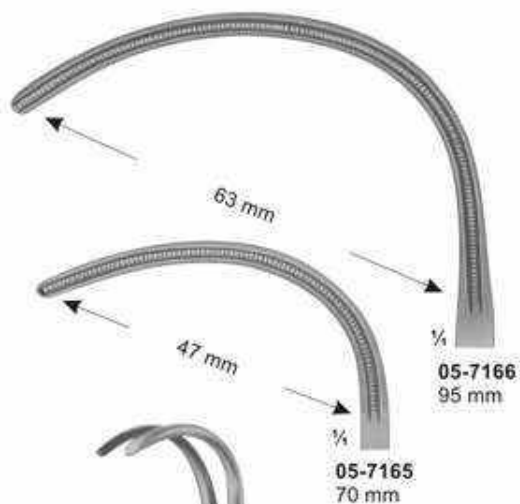

05-7165 - 05-7166
GLOVER
05-7165 195mm /19.5cm /8 Inch
05-7166 210mm /21cm /8 Inch



05-7167
GLOVER
220 mm/22cm /9 Inch

Atraumata Anastomosis, Vena-Cava Clamps

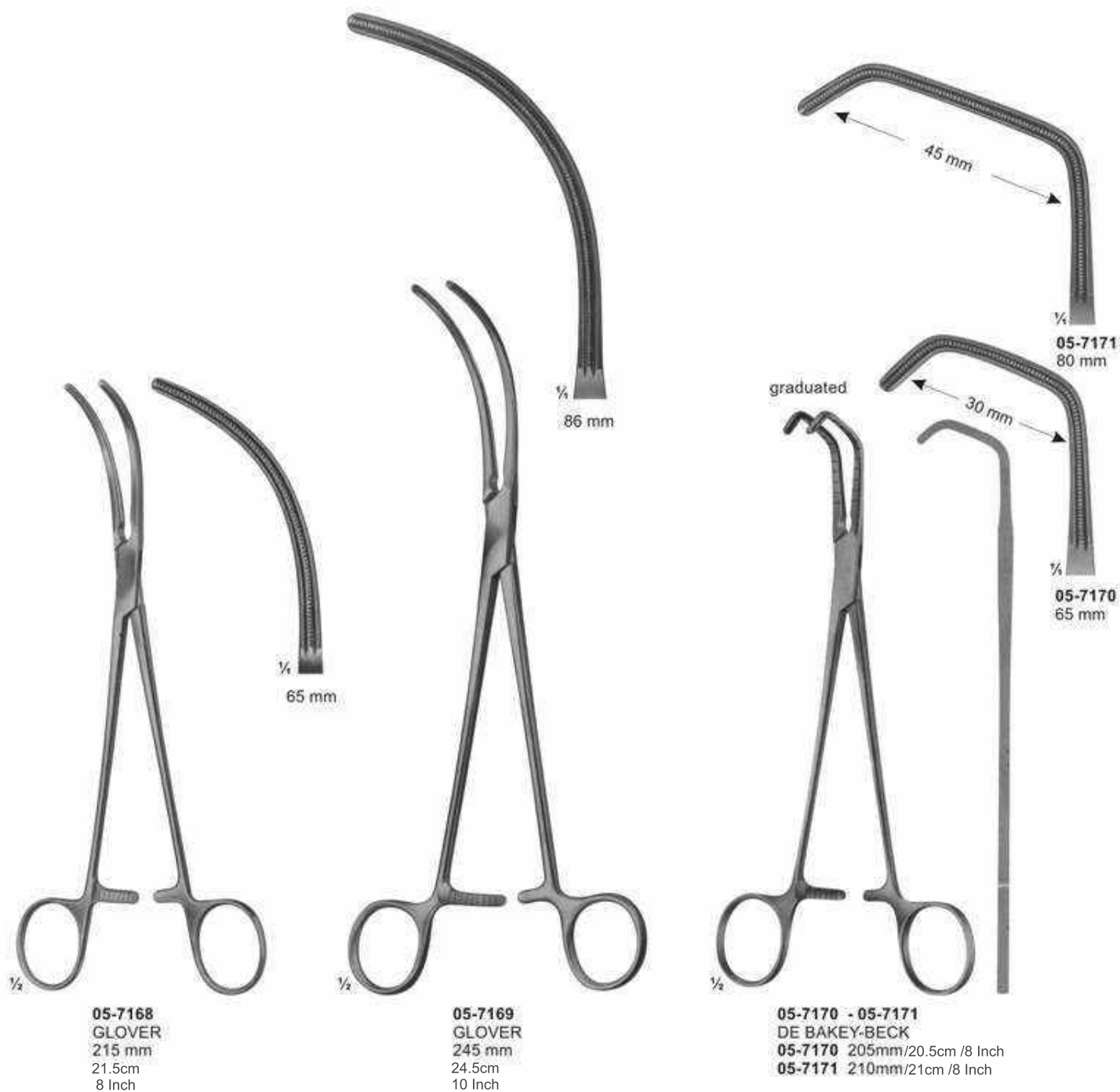

Atraumata Vena-Cava Clamps And Tangential Occlusion Clamps



05-7172 - 05-7175
DE BAKEY-HARKEN
05-7172 - 255 mm / 25.5cm / 10 Inch
05-7173 - 245 mm / 24.5cm / 10 Inch
05-7174 - 245 mm / 24.5cm / 10 Inch
05-7175 - 245 mm / 24.5cm / 10 Inch



graduated

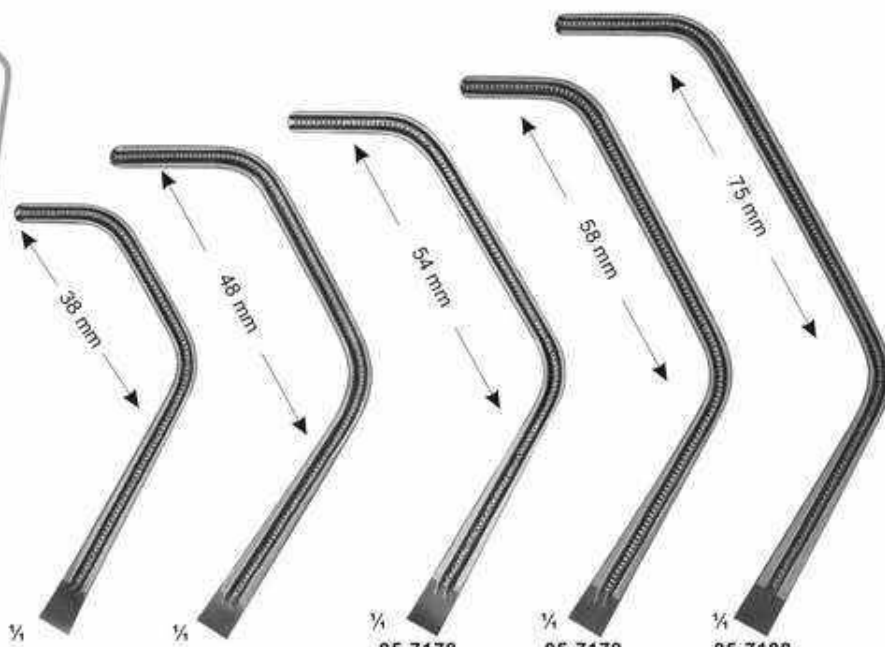

05-7176 - 05-7180
DE BAKEY

Total Length:

220 mm
22cm
9 Inch

265 mm
26.5cm
10 Inch

270 mm
27cm
11 Inch

270 mm
27cm
11 Inch

280 mm
28cm
11 Inch

Atraumata Tangential Occlusion And Coarctation Clamps



05-7181 - 05-7183
DE BAKY-SATINSKY

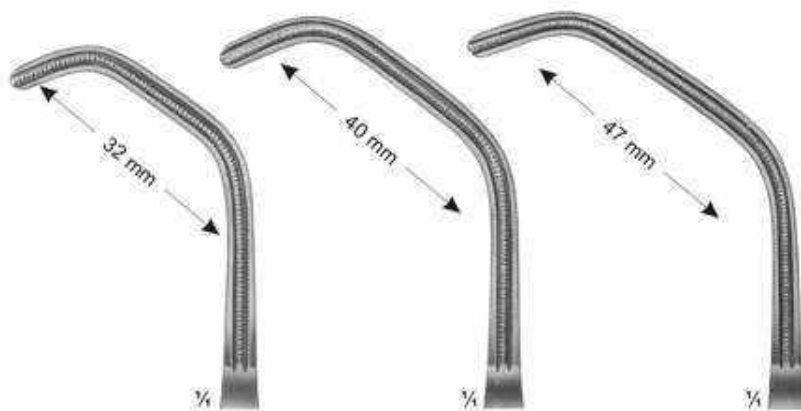

05-7181
68 mm
Length 235mm

05-7182
76 mm
Length 240mm

05-7183
84 mm
Length 245mm



05-7184 - 05-7185
DE BAKY
05-7184 170mm /17cm /7 Inch
05-7185 165mm /16.5cm /6 Inch

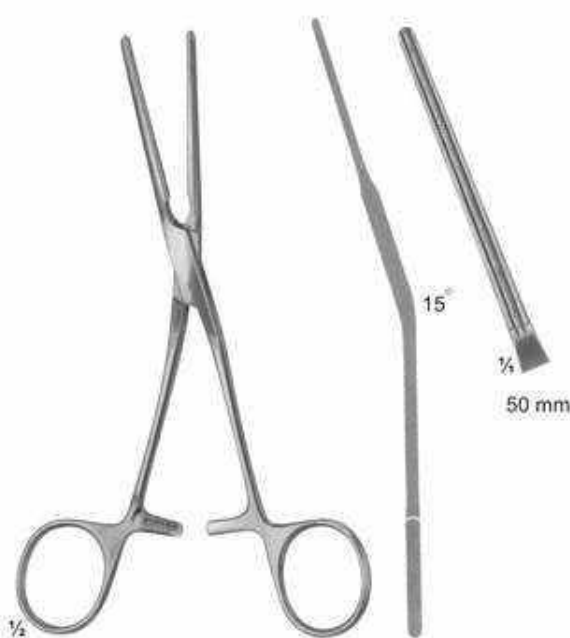

05-7186
DE BAKY
165 mm/16.5cm /6 Inch

Atraumata Coarctation Clamps, Patent-Ducts Clamps



Atraumata Peripheral-Vascular Clamps



05-7196
DE BAKEY
 190 mm / 19cm / 7 Inch



05-7197
DE BAKEY
 200 mm / 20cm / 8 Inch

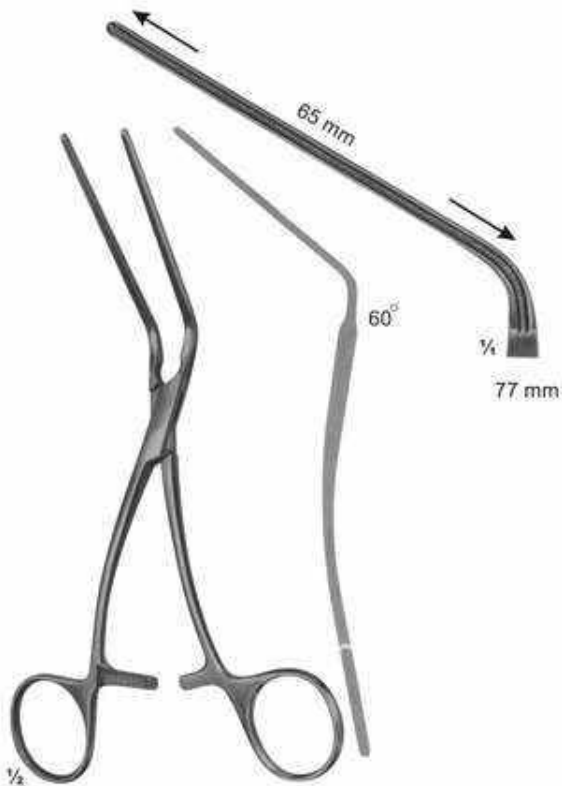

05-7198
DE BAKEY
 180 mm
 18cm
 7 Inch

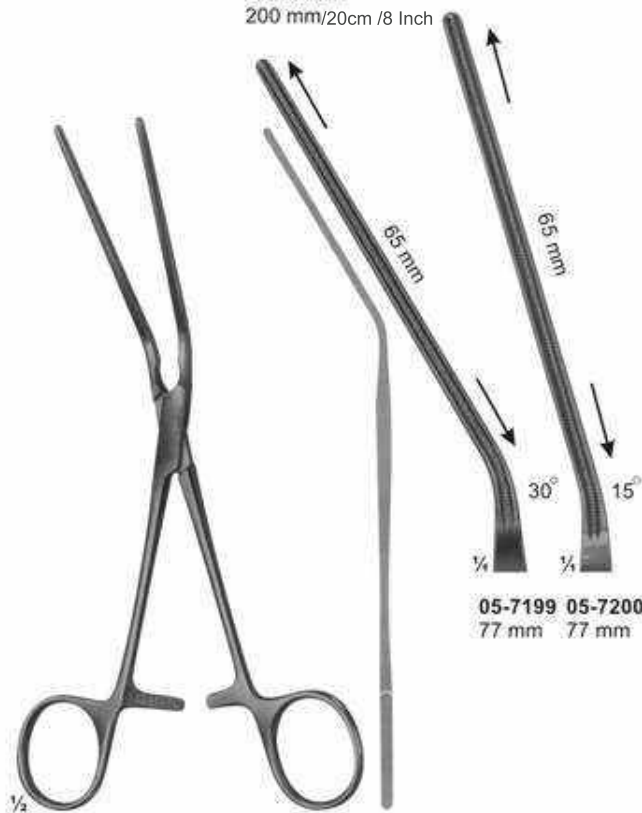

05-7199 - 05-7200
LELAND-JONES
 190 mm
 19cm
 7 Inch

Atraumata Peripheral Vascular And Anastomosis Clamps



05-7201
LELAND-JONES
 195 mm
 19.5cm
 8 Inch

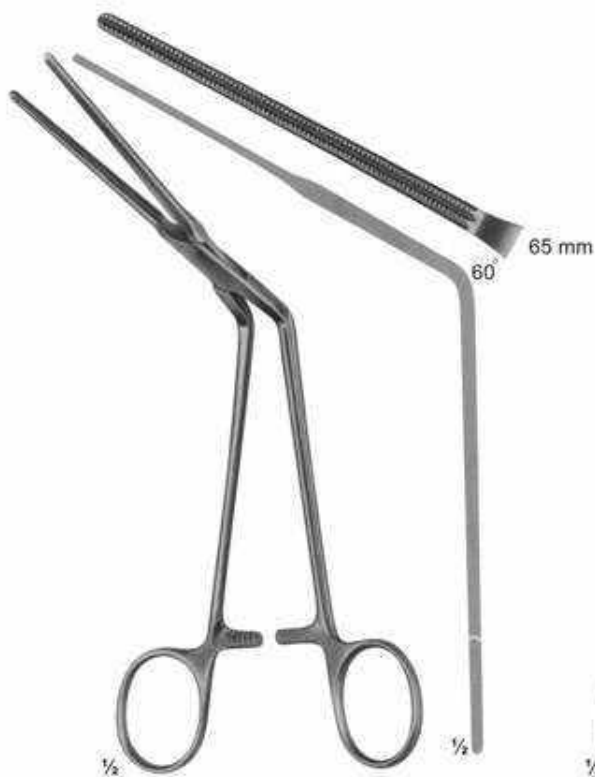

05-7202
DE BAKEY
 200 mm
 20cm
 8 Inch



Iliac clamp



05-7203
WERTHEIM
 250 mm
 25cm
 10 Inch

Atraumata Anastomosis And Ascending Aorta Cross Clamps



05-7204 - 05-7206

DICK

05-7204 255mm /25.5cm /10 Inch

05-7205 265mm /26.5cm /10 Inch

05-7206 275mm /27.5cm /11 Inch



05-7207

MORRIS

175 mm

17.5cm

7 Inch

Atraumata Ascending Aorta Cross, Bronchus Clamps

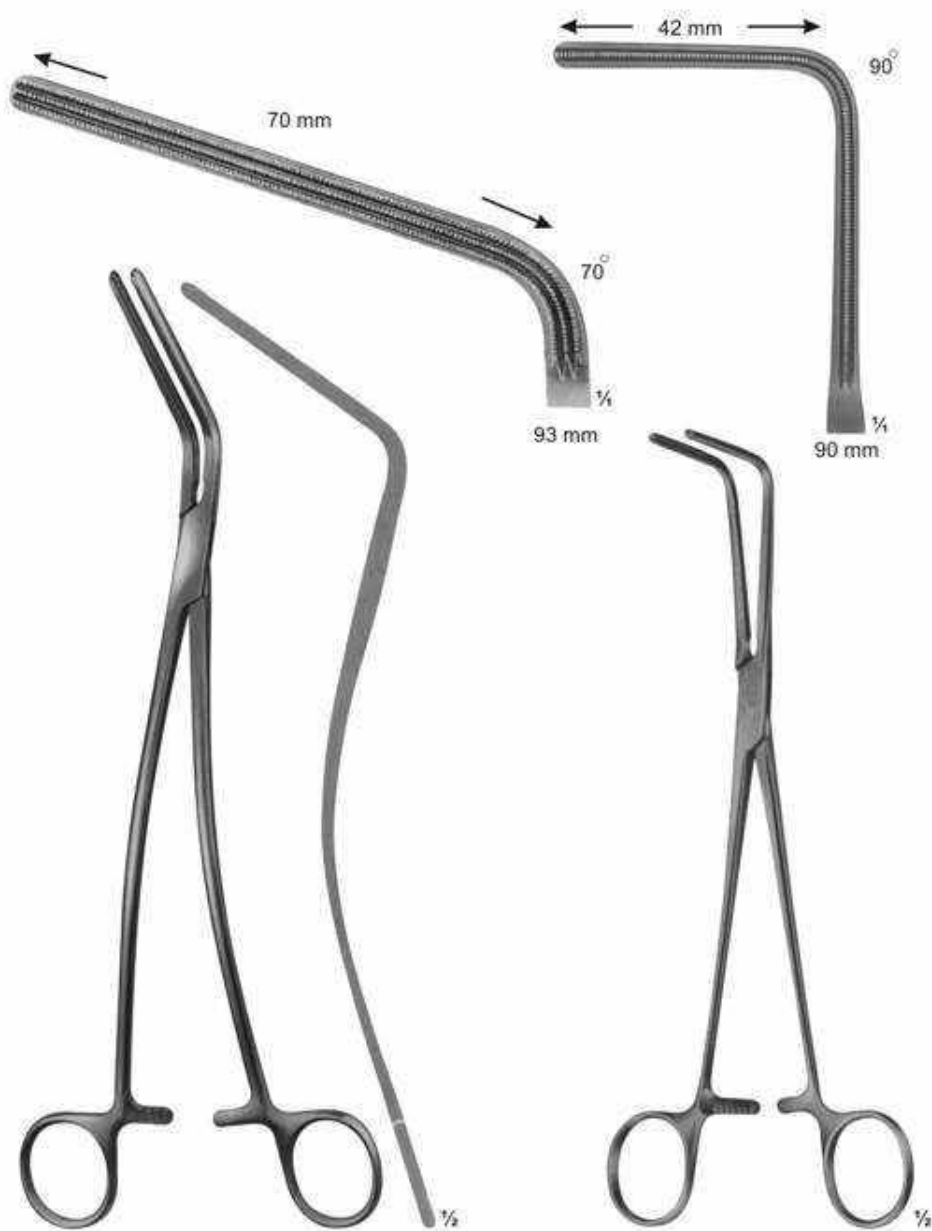

05-7208
 DE BAKEY (Morris Modif)
 240 mm
 24cm
 9 Inch



05-7209
 LEES
 220 mm
 22cm
 9 Inch



05-7210
 LEES
 245 mm
 24.5cm
 10 Inch

Atraumata Aorta-Aneurysm Clamps

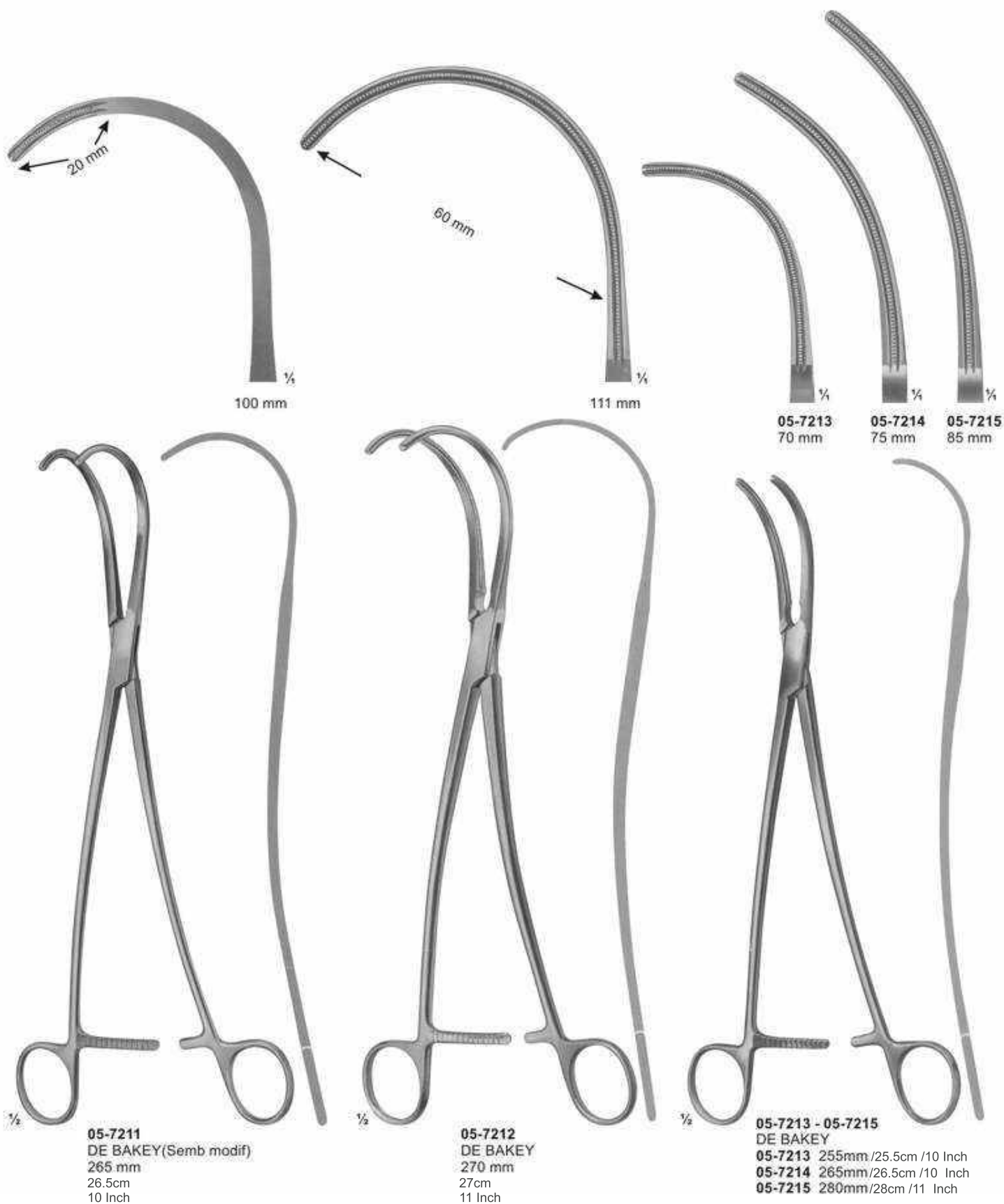

Atraumata Aorta-Aneurysm Clamps



2.3 Teeth Rows

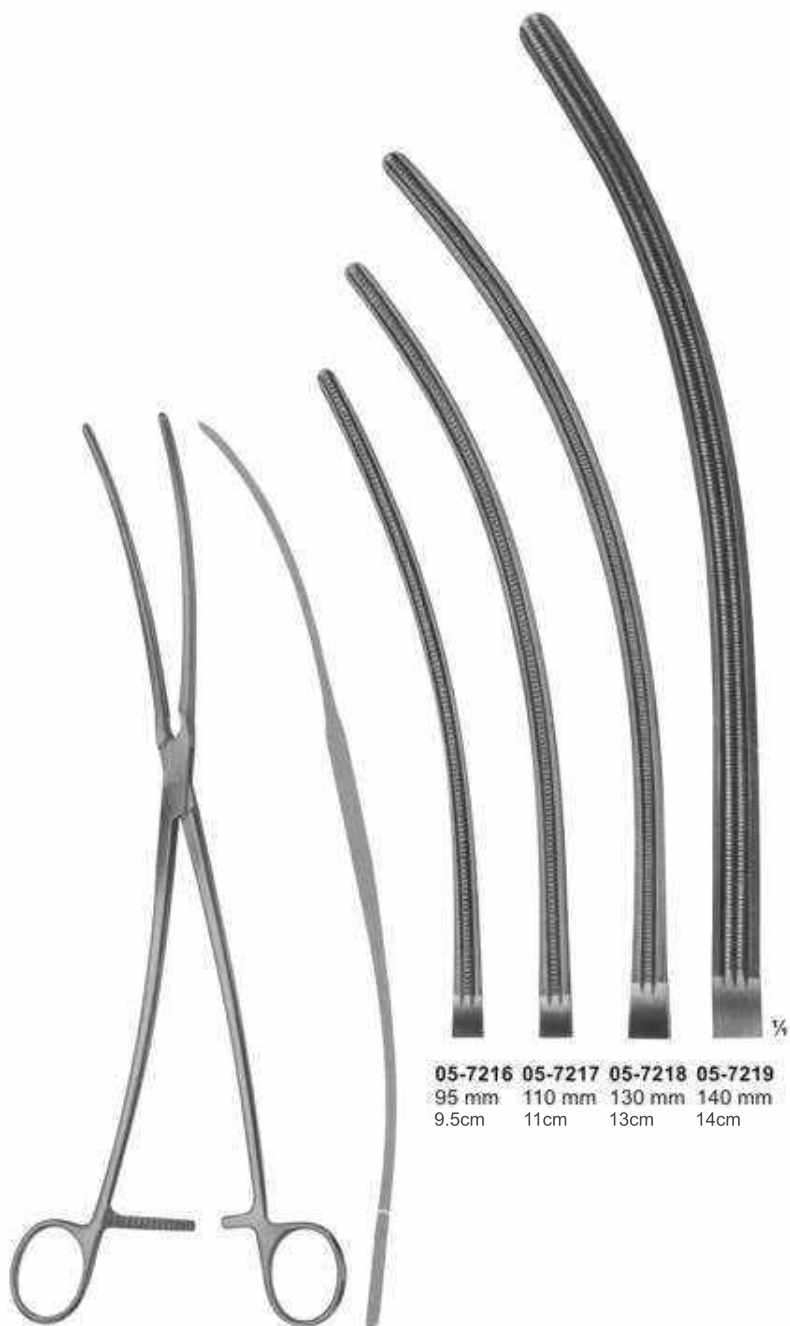

05-7216	05-7217	05-7218	05-7219
95 mm	110 mm	130 mm	140 mm
9.5cm	11cm	13cm	14cm

05-7216 - 05-7219

DE BAKEY

05-7216 250mm /25cm /10 Inch

05-7217 300mm /30cm /12 Inch

07-7218 315mm /31.5cm /12 Inch

07-7219 330mm /33cm /13 Inch



115 mm

05-7220

DE BAKEY

300 mm /30cm /12 Inch

Atraumata Aorta Clamps

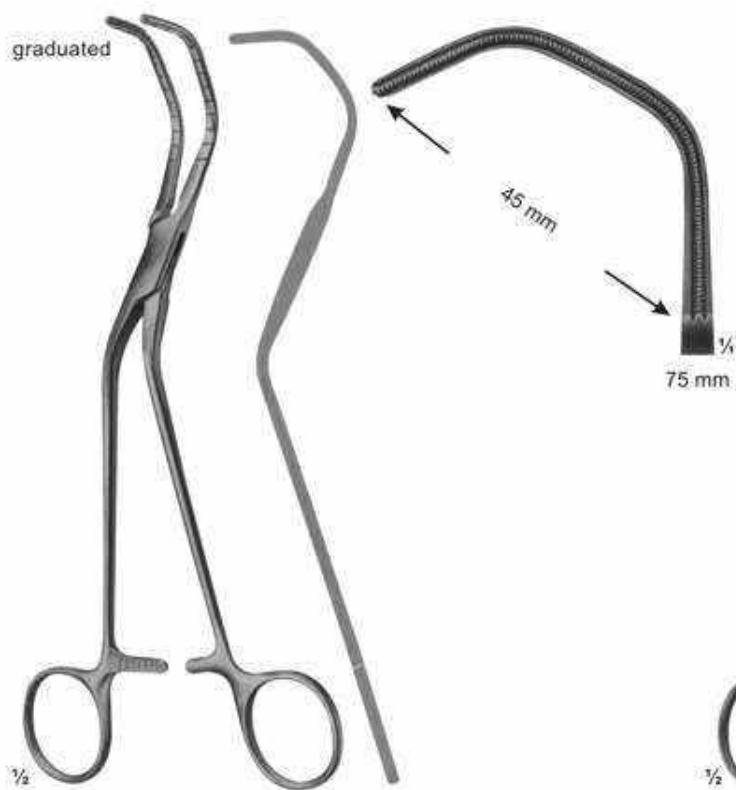

05-7221
DIETRICH
210 mm
21cm
8 Inch

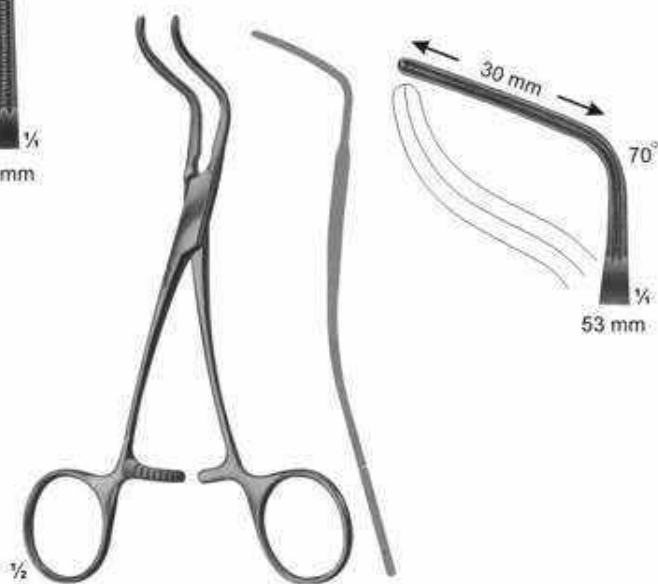

05-7222
SUBRAMANIAN (Modif)
155 mm
15.5cm
6 Inch

Atraumata Aorta Clamps

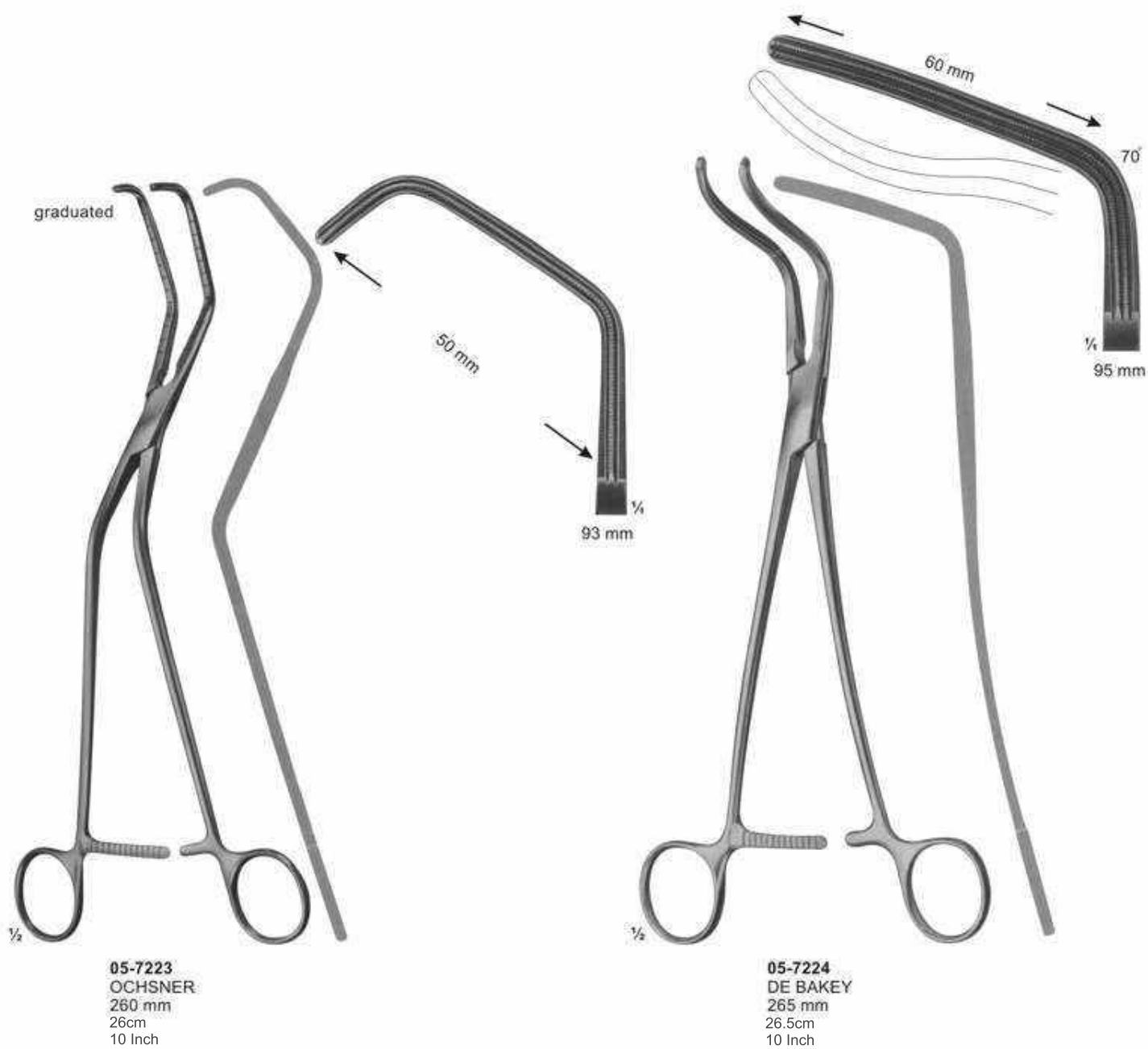

Atraumata Aorta-Anastomosis Clamps



L
05-7225
WEBER
 260 mm
 26cm
 10 Inch



R
05-7226
WEBER
 260 mm
 26cm
 10 Inch

Multi-Purpose Clamps



½ 05-7227 - 05-7230
DE BAKEY

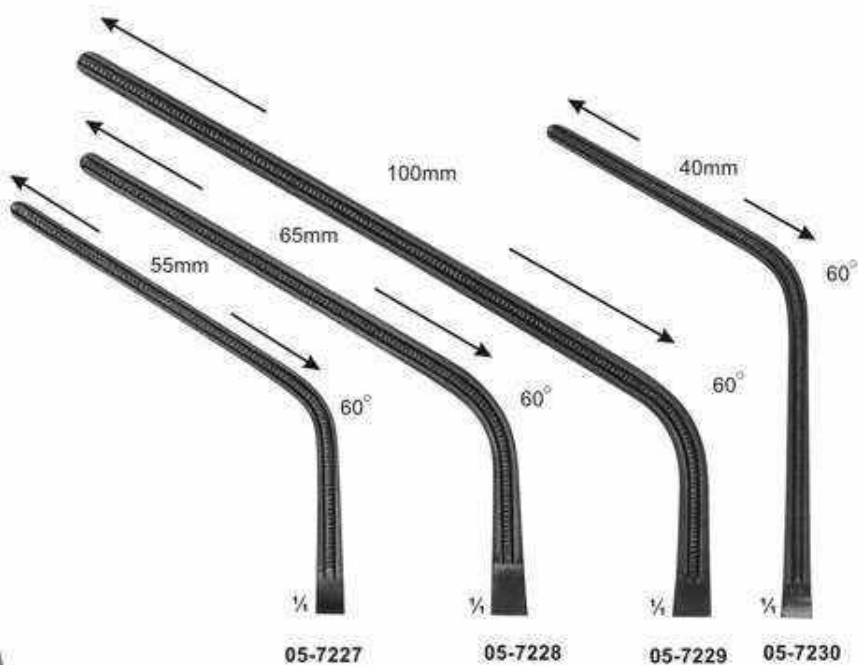

Total Length:	230 mm	280 mm	305 mm	240 mm
Length of jaws:	85 mm	100 mm	135 mm	93 mm

05-7227

05-7228

05-7229

05-7230



½ 05-7231 - 05-7234

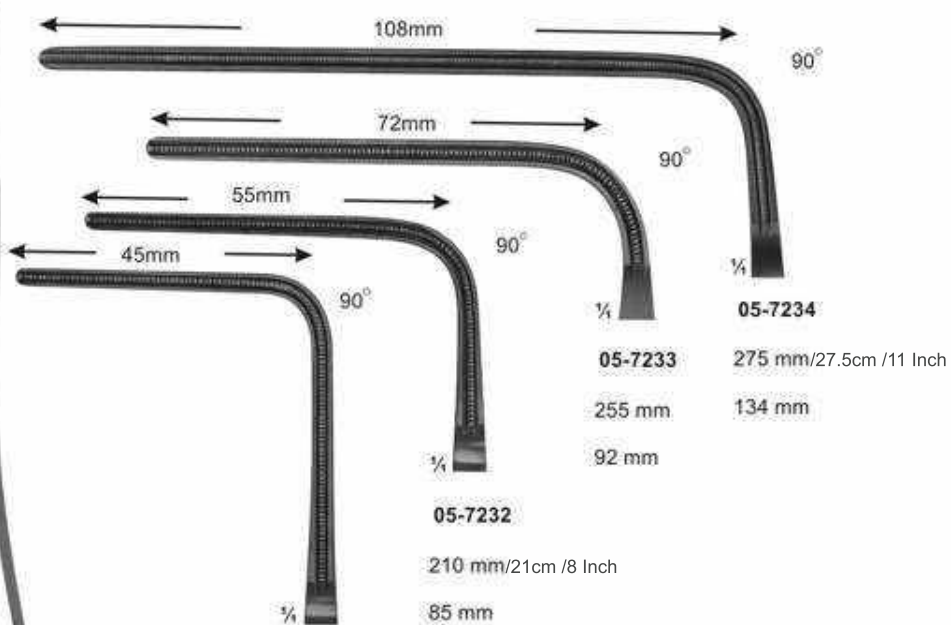

Total Length:	225 mm / 22.5cm / 9 Inch
Length of jaws:	93 mm

05-7231

05-7232

05-7233

05-7234

275 mm / 27.5cm / 11 Inch

255 mm

134 mm

92 mm

85 mm

Ring Handle Bulldog Clamps Anastomosis Clamps, Pediatric Types



05-7235
50mm

05-7236
50mm

05-7235 - 05-7236
COOLEY
125 mm,
12.5cm
5 Inch



05-7237
COOLEY
100 mm
10cm
4 Inch

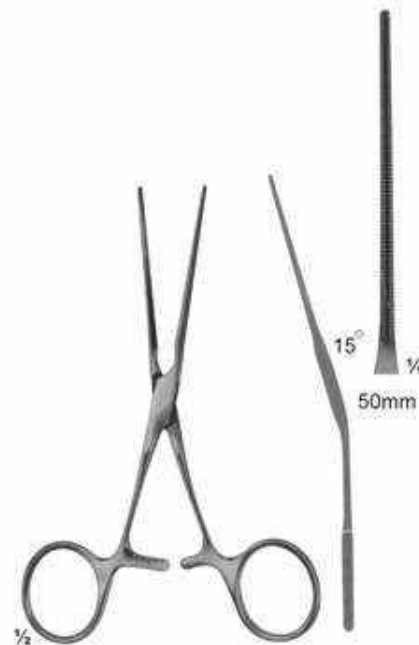

05-7238
COOLEY
125 mm
12.5cm
5 Inch

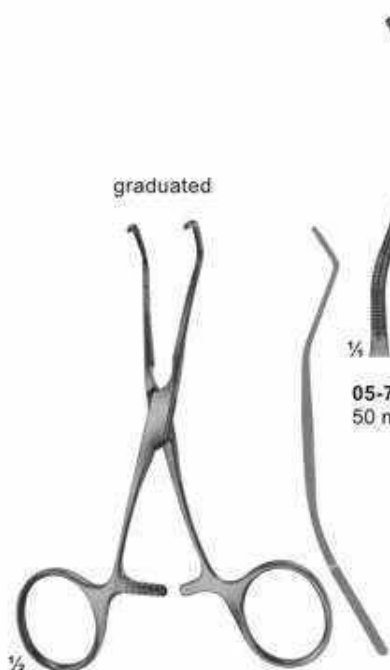

graduated

05-7239
50 mm

05-7240
50 mm

05-7239 - 05-7240
COOLEY
120 mm,
12cm
5 Inch

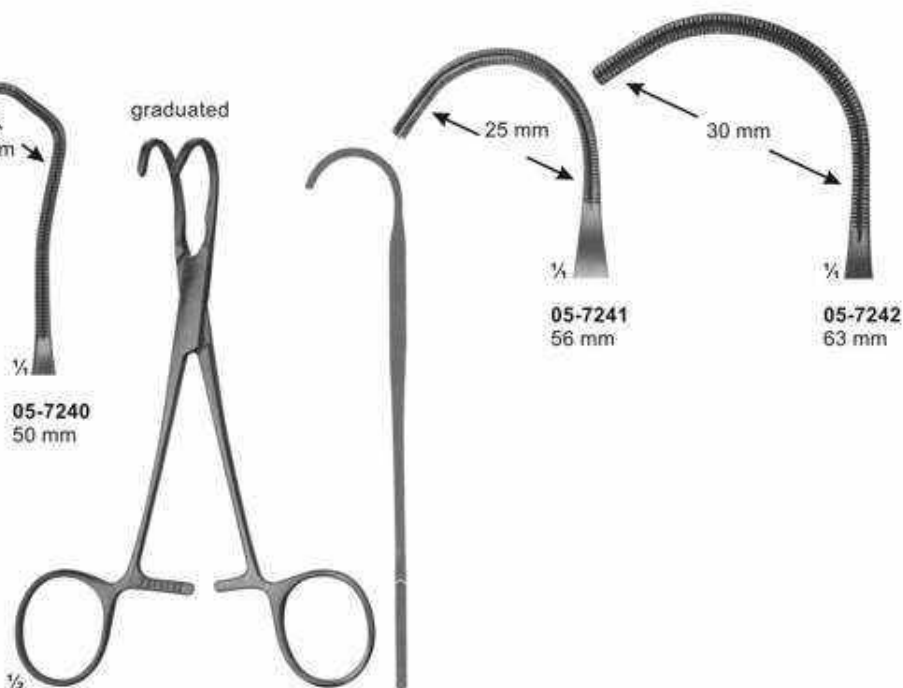

graduated

05-7241
56 mm

05-7242
63 mm

05-7241 - 05-7242
COOLEY-BECK
150 mm,
15cm
6 Inch

Anastomosis Clamps, Pediatric Types

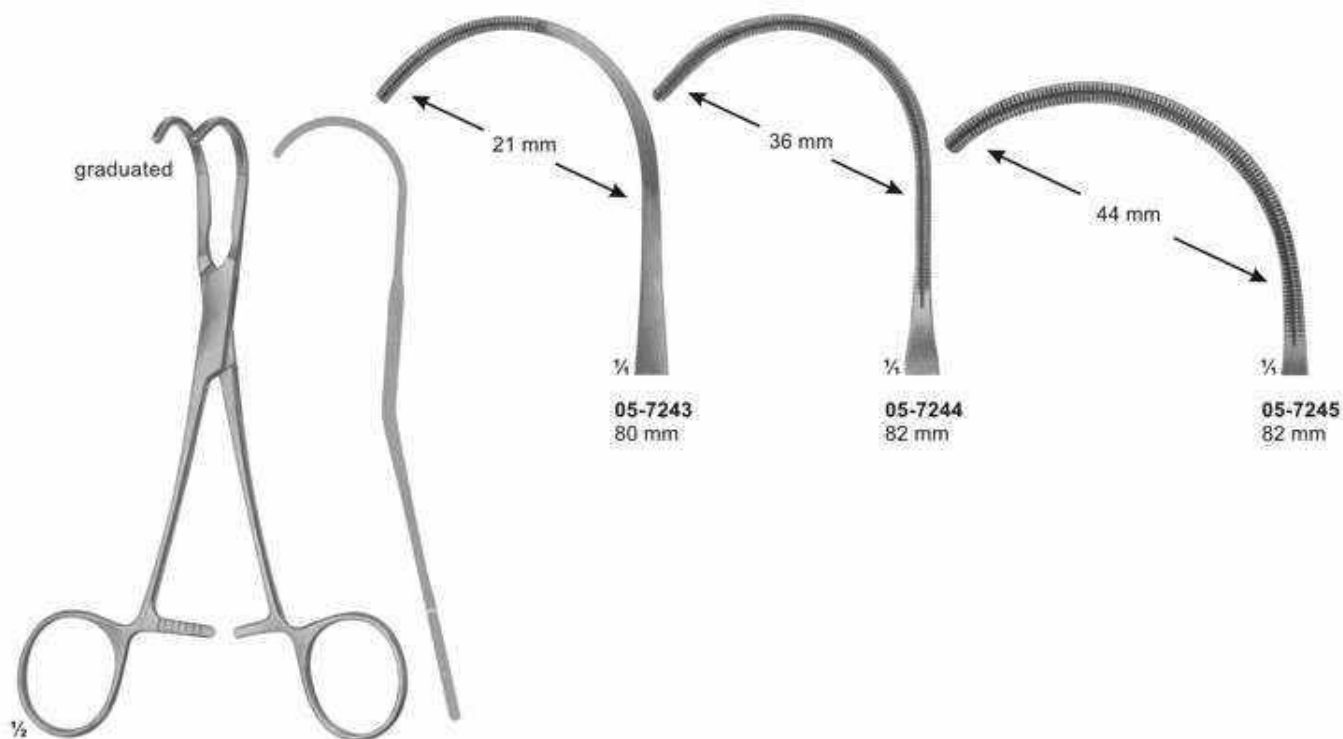

05-7243 - 05-7245
COOLEY
170 mm / 17cm / 7 Inch

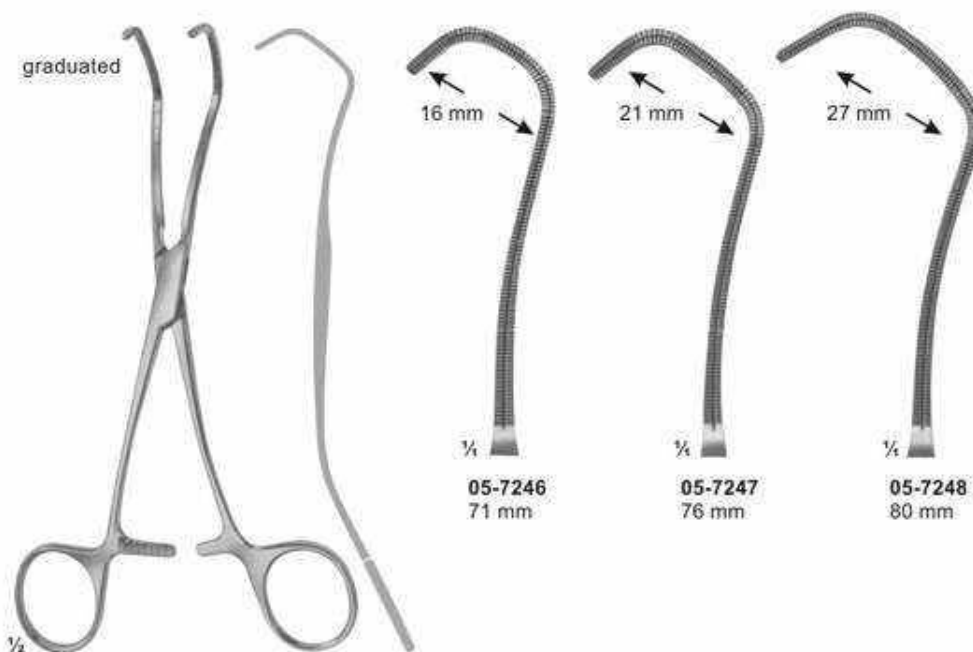

05-7246 - 05-7248
DERRA-COOLEY
05-7246 170mm / 17cm / 7 Inch
05-7247 175mm / 17.5cm / 7 Inch
05-7248 175mm / 17.5cm / 7 Inch

Anastomosis Clamps Multi-Purpose Clamps Pediatric Types

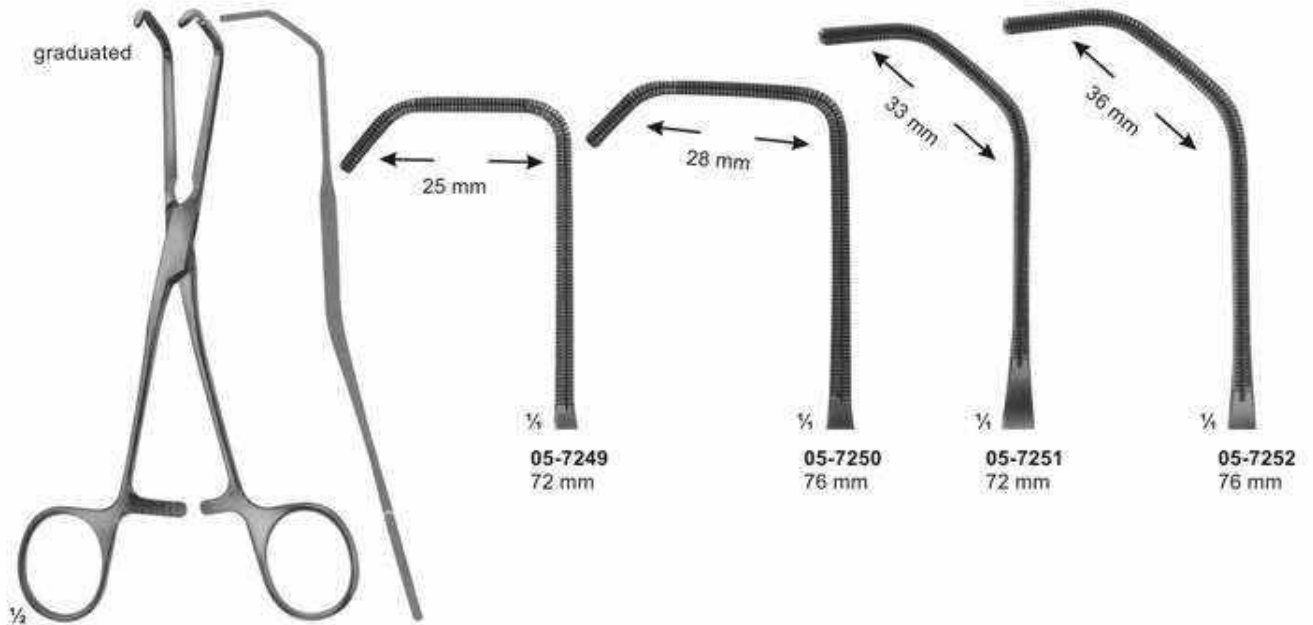

05-7249 - 05-7252

COOLEY

05-7249 165mm/16.5cm /6 Inch

05-7250 165mm/16.5cm /6 Inch

05-7251 175mm/17.5cm /7 Inch

05-7252 180mm/18cm /7 Inch

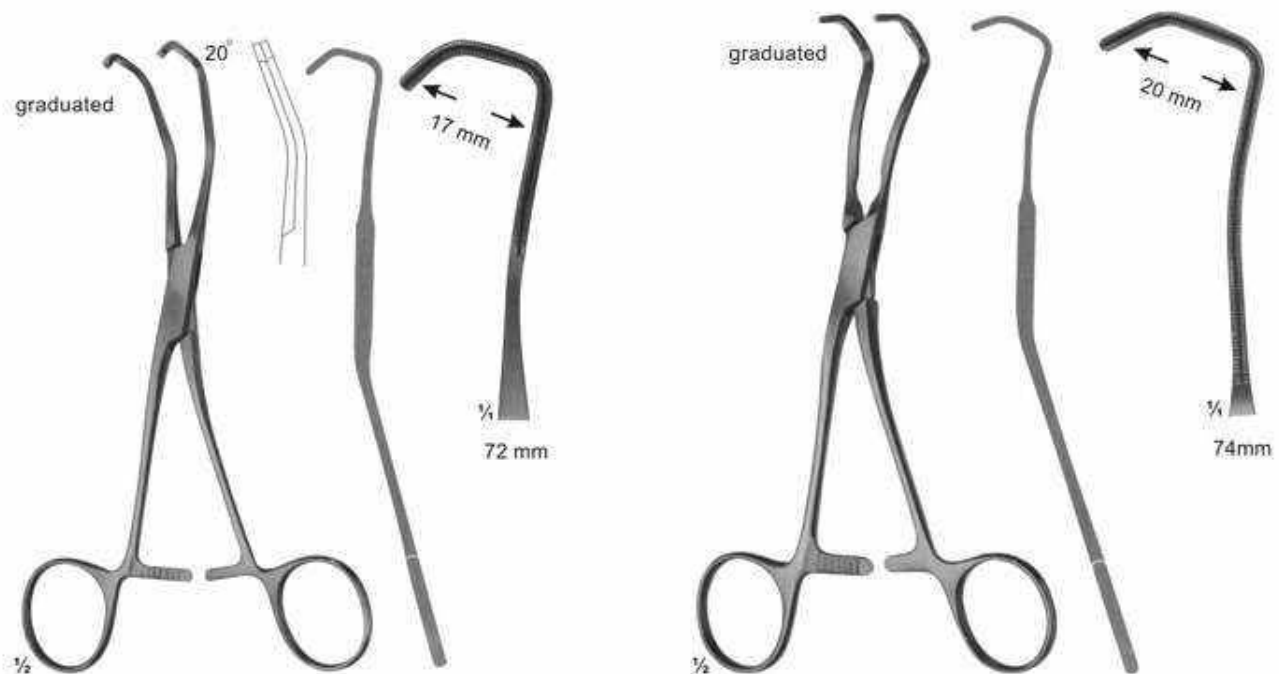

Multi-Purpose Clamps, Pediatric Types

graduated

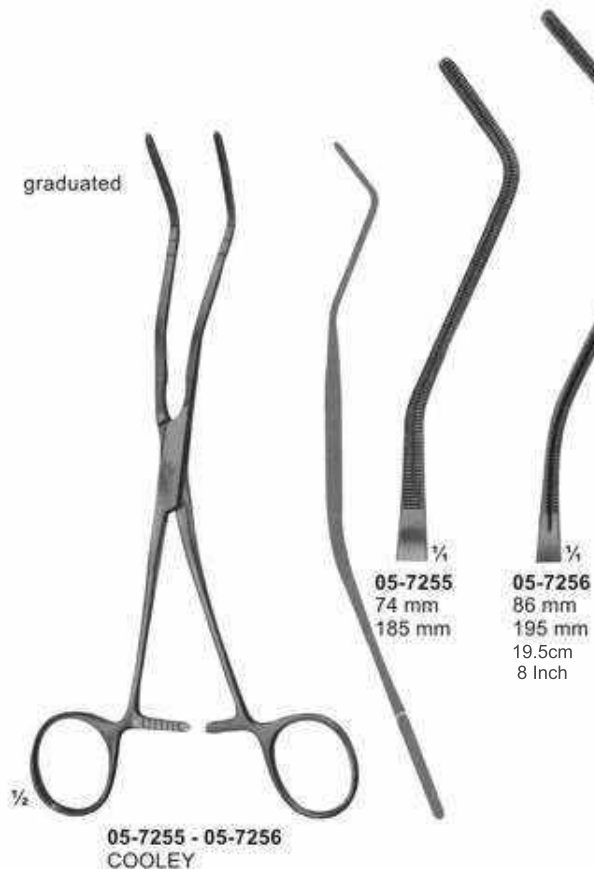

graduated



graduated

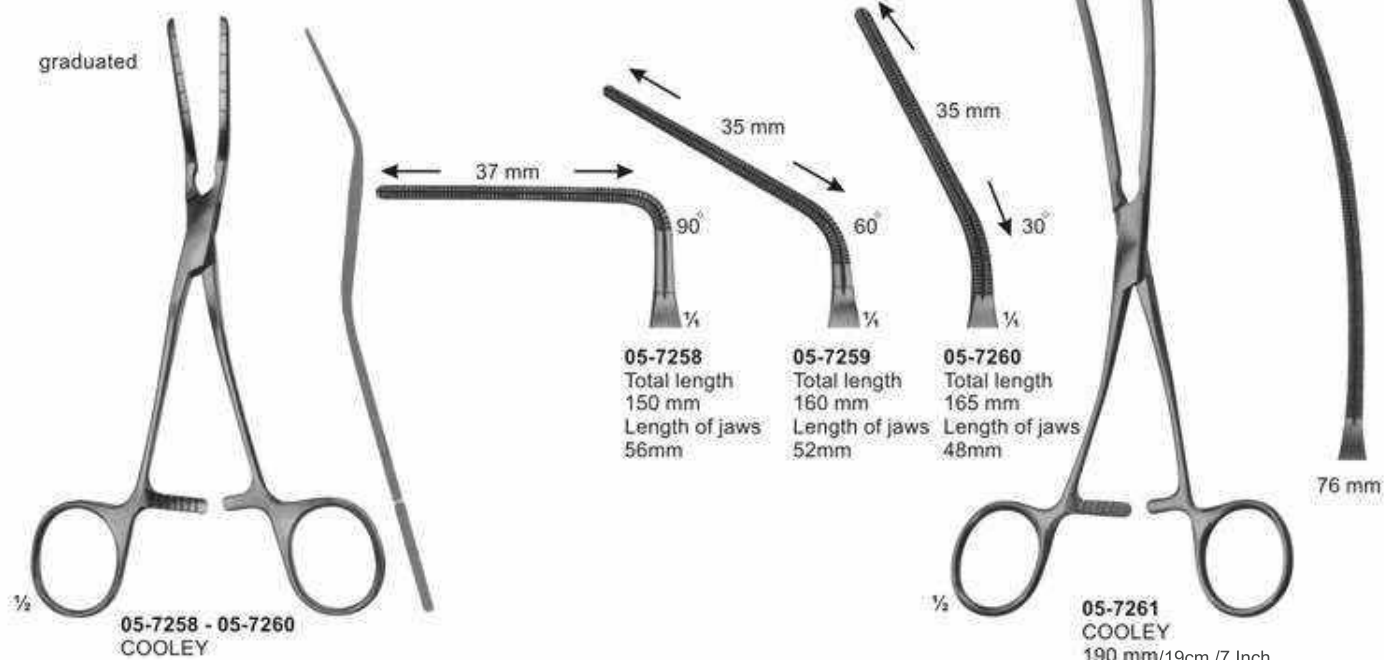

05-7261
COOLEY
190 mm/19cm /7 Inch

Atraumata Aorta Clamps, Patent-Ductus Clamps, Coarctation Clamps Pediatric Types

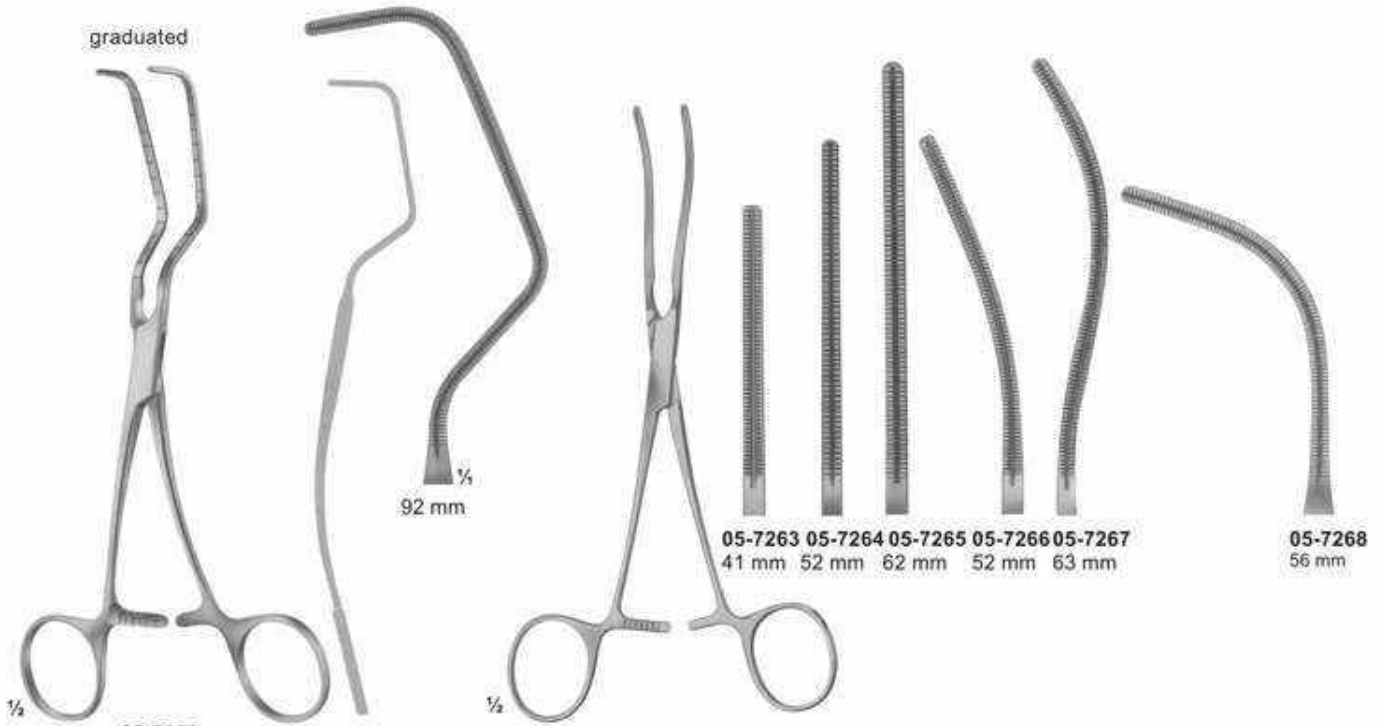

05-7262
PARRY-COOLEY
185 mm
18.5cm
7 Inch

05-7263 - 05-7268
COOLEY
05-7263 160mm /16cm /6 Inch
05-7264 170mm /17cm /7 Inch
05-7265 180mm /18cm /7 Inch
05-7266 180mm /18cm /7 Inch
05-7267 180mm /18cm /7 Inch
05-7268 160mm /16cm /6 Inch

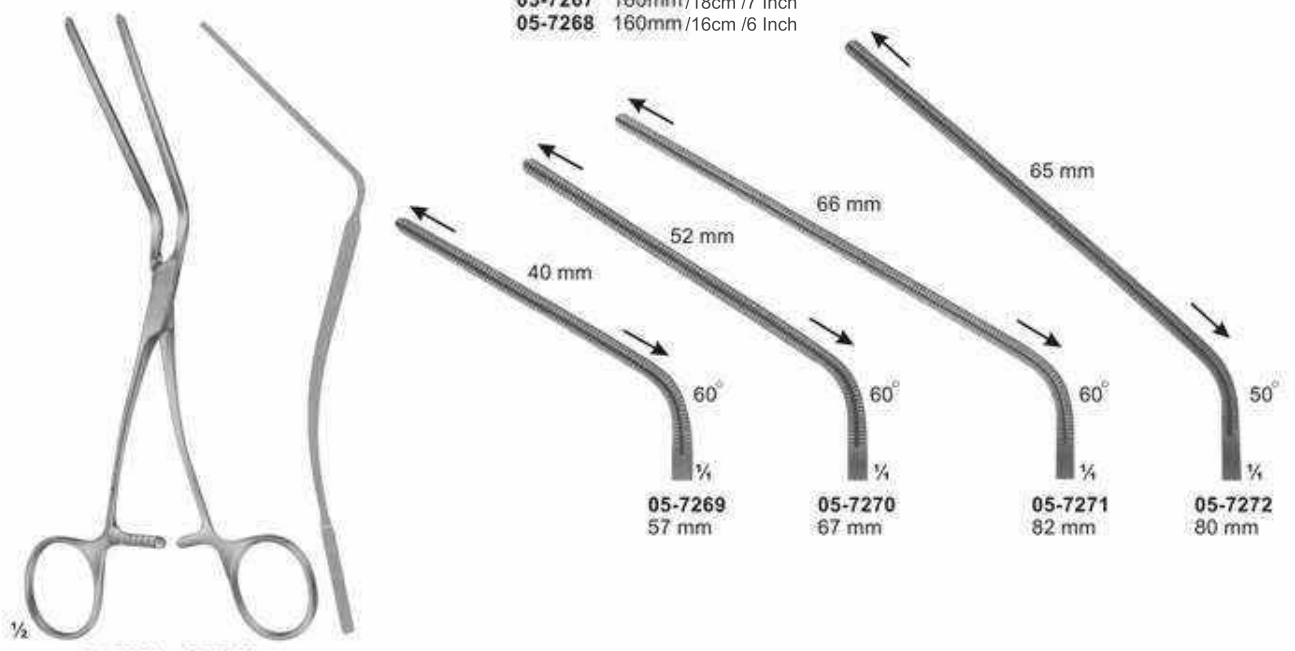

05-7269 - 05-7272
05-7269 165mm /16.5cm /6 Inch
05-7270 170mm /17cm /7 Inch
05-7271 185mm /18.5cm /7 Inch
05-7272 185mm /18.5cm /7 Inch

Multi-Purpose Clamps



05-7273 - 05-7282

DARDIK

05-7273 150 mm	05-7278 170 mm /17cm /7 Inch
05-7274 150 mm	05-7279 170 mm /17cm /7 Inch
05-7275 150 mm	05-7280 170 mm /17cm /7 Inch
05-7276 145 mm	05-7281 160 mm /16cm /6 Inch
05-7277 130 mm	05-7282 135 mm /13.5cm /5 Inch

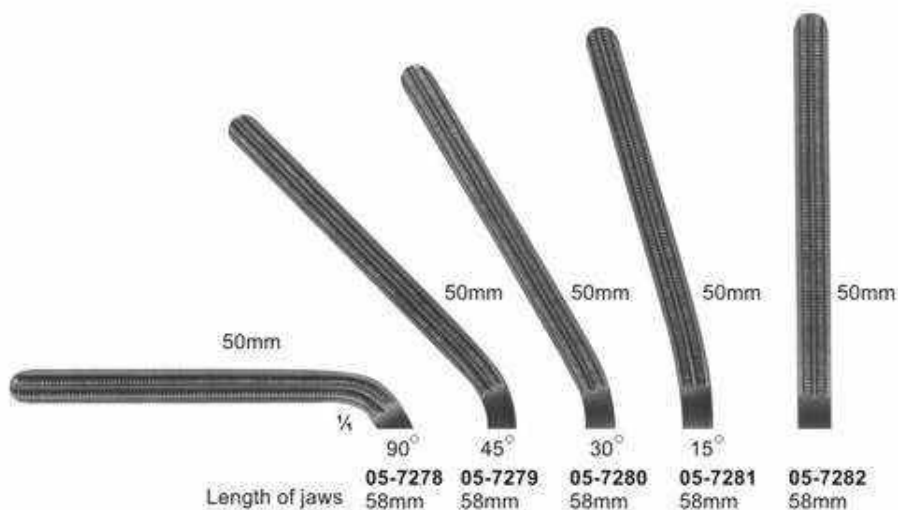
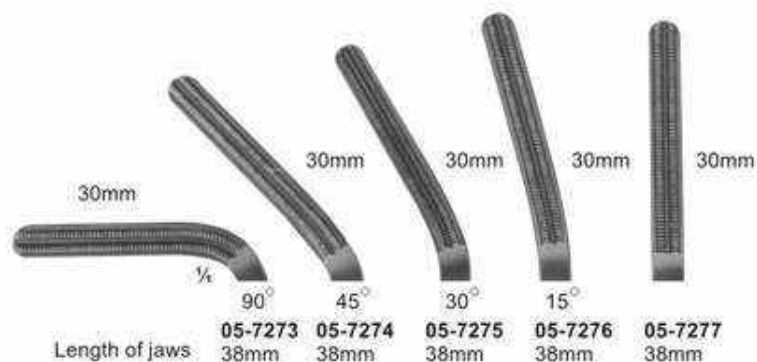

Lung Grasping Forceps



05-7283
WILLIAMS
160 mm
16cm
6 Inch



05-7284
TUTTLE
230 mm



05-7285
NELSON
230 mm
23cm
9 Inch



05-7286
DUVAL
230 mm
23cm
9 Inch



05-7287 - 05-7289
BABCOCK
05-7287 170 mm /17cm /7 Inch
05-7288 215 mm /21.5cm /8 Inch



05-7290
ALLIS
220 mm /22cm /9 Inch

Dissecting And Ligature Forceps



05-7291
FINOCHIETTO
 245 mm
 24.5cm
 10 Inch



05-7292

05-7292 - 05-7293
SEMB
 240 mm
 24cm
 10 Inch

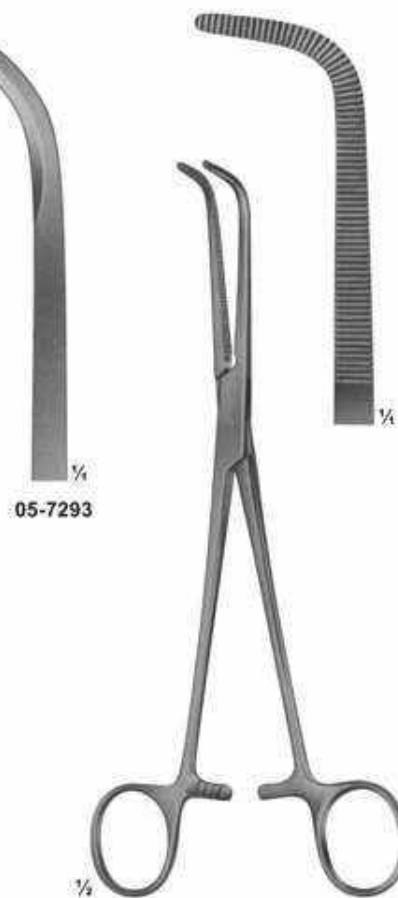

05-7293

05-7294
WIKSTROEM
 205 mm
 20.5cm
 8 Inch

Dissecting And Ligature Forceps, Vessel Clamps



05-7295
 MIXTER
 230 mm
 23cm
 10 Inch



05-7296 **05-7297**
 220 mm 250 mm
 22cm 22cm
 9 Inch 10 Inch



05-7298
 HOEPFNER
 Vessel clamp
 160 mm
 16cm
 6 Inch

Vena Cava Clamps

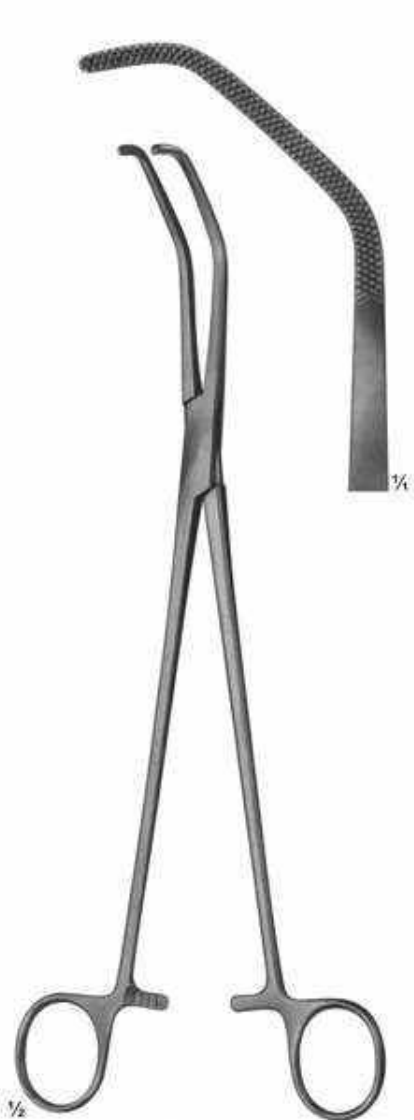

05-7299
SATINSKY
 Anastomosis clamps
 265 mm
 26.5cm
 10 Inch

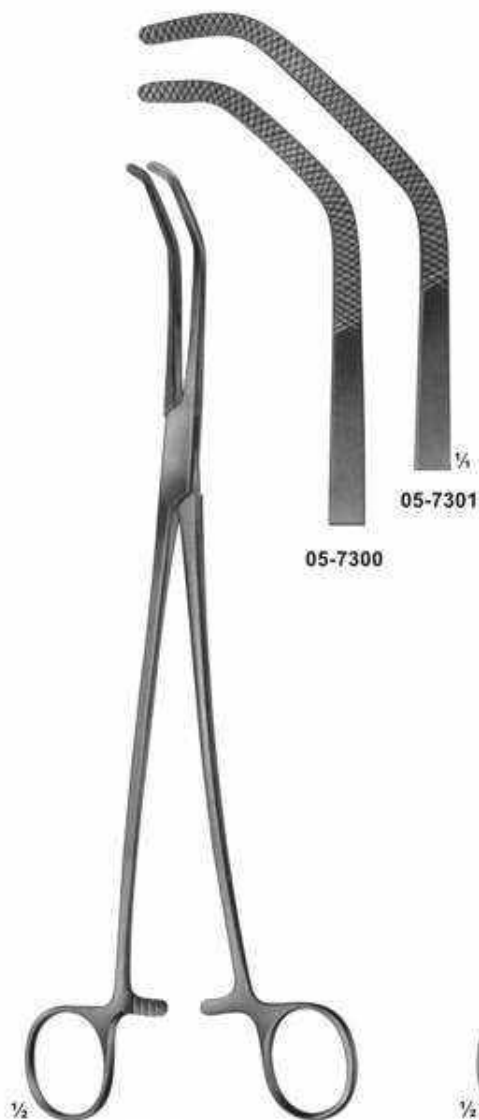

05-7300 - 05-7301
SATINSKY
 Anastomosis clamps
 265 mm
 26.5cm
 10 Inch



05-7302
HARKEN
 240 mm
 24cm
 9 Inch

Carotid Clamps, Auricle Clamps



05-7303
PERTUISET
 Carotid Clamp
 90 mm

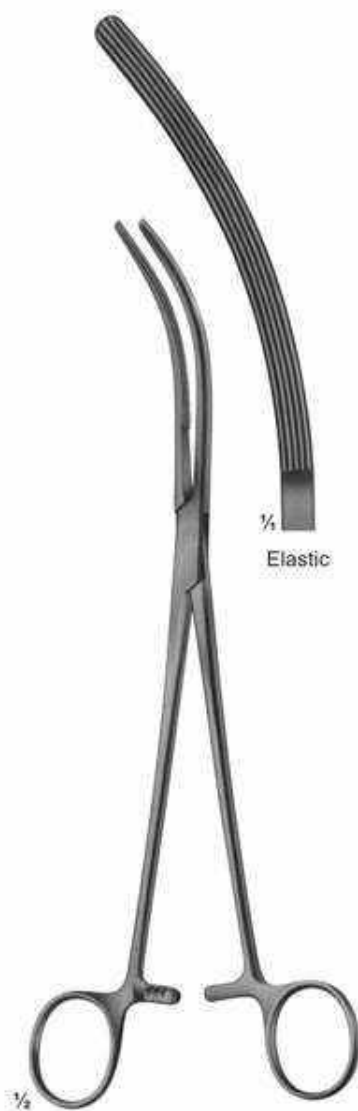

05-7304
CRAFOORD-SELLORS
 240 mm
 24cm
 9 Inch



05-7305 - 05-7306
CRAFOORD
 240 mm
 24cm
 9 Inch

Bronchus Forceps



05-7307
PRICE THOMAS
 225 mm
 22.5cm
 9 Inch



05-7308 - 05-7309
PRICE THOMAS
 225 mm
 22.5cm
 9 Inch



05-7308
 jaws with pins



05-7309
 jaws with pins

Sternum Instruments And Rib Shears



05-7310
SCHUMACHER
Sternum shears
210 mm
21cm
8 Inch



05-7311
LEBSCHKE
Sternum chisel
200 mm
20cm
8 Inch



05-7312
230 mm
23cm
9 Inch



05-7313
COLLIN
195 mm
19.5cm
8 Inch



05-7314
GLUCK
190 mm
19cm
7 Inch



05-7315
BETHUNE
340 mm
34cm
13 Inch



05-7316
BRUNNER
Universal Pattern
340 mm
34cm
13 Inch



05-7317
GIERTZ-STILLE
250 mm
25cm
10 Inch

**Rib Holding Forceps, Bone Cutting Forceps,
Rib Rongeurs**



05-7318
SEM B
Rib and Bone
Holding forceps
190 mm
19cm
7 Inch



05-7319
SEM B
Rib and Bone
Holding forceps
190 mm
19cm
7 Inch



05-7320
LISTON-STILLE
265 mm
26.5cm
10 Inch



05-7321
LISTON-KEY-HORSLEY
(Tudor Edwards)
255 mm
25.5cm
10 Inch

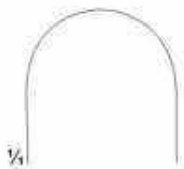

05-7323

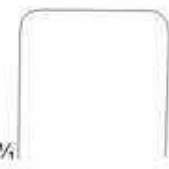

05-7324

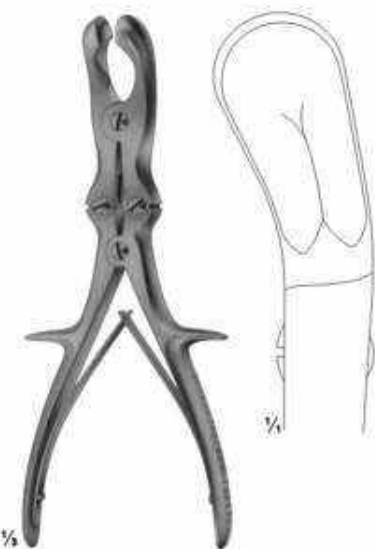

05-7322
SEM B
Rib Rongeur to shorten
the rib stumps
240 mm /24cm /9 Inch



05-7323 - 05-7324
SAUERBRUCH-CORYLLOS
Rib rongeurs to shorten
the rib stumps
310 mm /31cm /12 Inch



05-7325
MARKWALDER
Rib Rongeur to Round
the rib stumps
190 mm /19cm / 7 Inch

Rib Raspatories

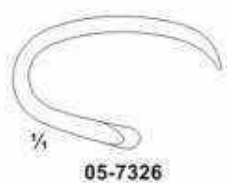

05-7326



05-7327



05-7326 - 05-7327
 DOYEN
 for children
 175 mm
 17.5cm
 7 Inch



05-7328



05-7329



05-7328 - 05-7329
 DOYEN
 for adults
 175 mm
 17.5cm
 7 Inch



05-7330



05-7331



05-7330 - 05-7331
 DOYEN
 240 mm
 24cm
 9 Inch

Rib Raspatories



05-7332 -05-7336
SEMB
 230 mm /23cm /9 Inch

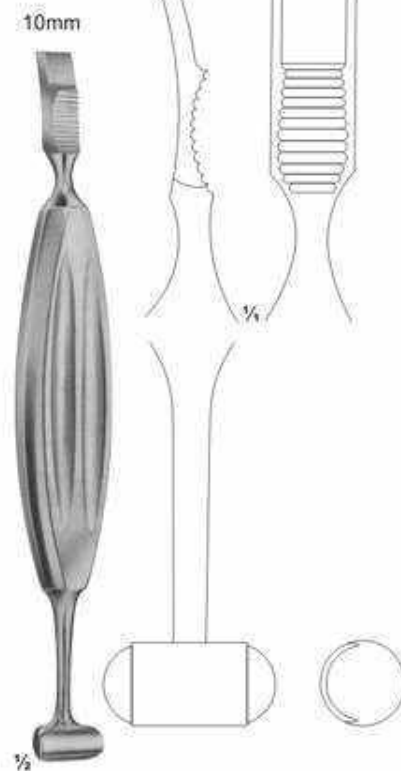
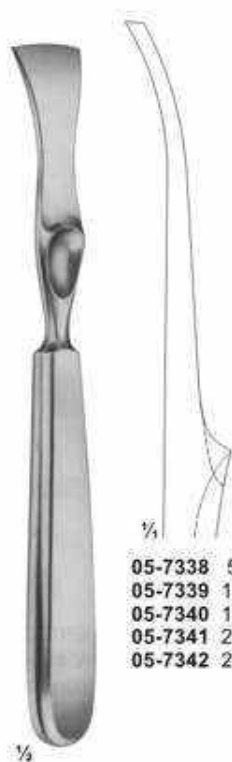
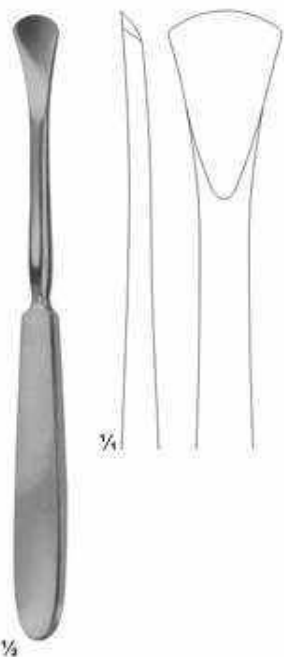

Rib Spreaders



05-7344
FINOCHIETTO
Blades
18X21 mm



05-7345
HERTZLER
Blades
20X25 mm



05-7346
TUFFIER
Blades
43X53 mm

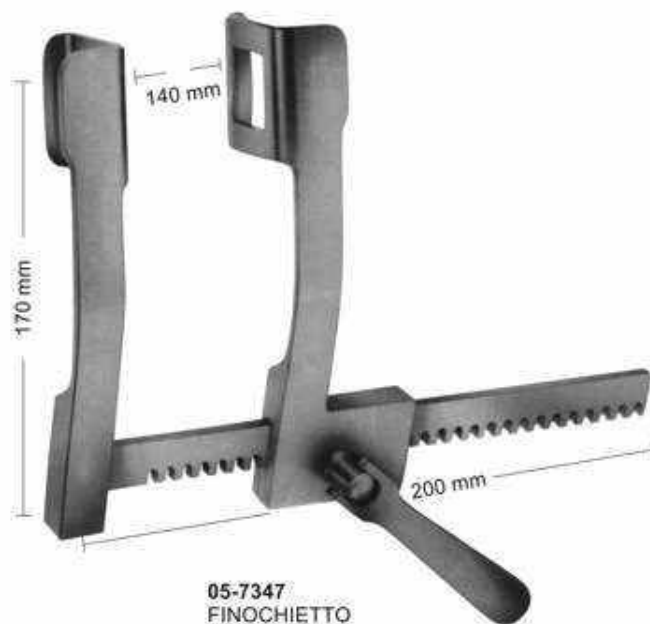

05-7347
FINOCHIETTO
Blades
36X45 mm

Rib Spreaders

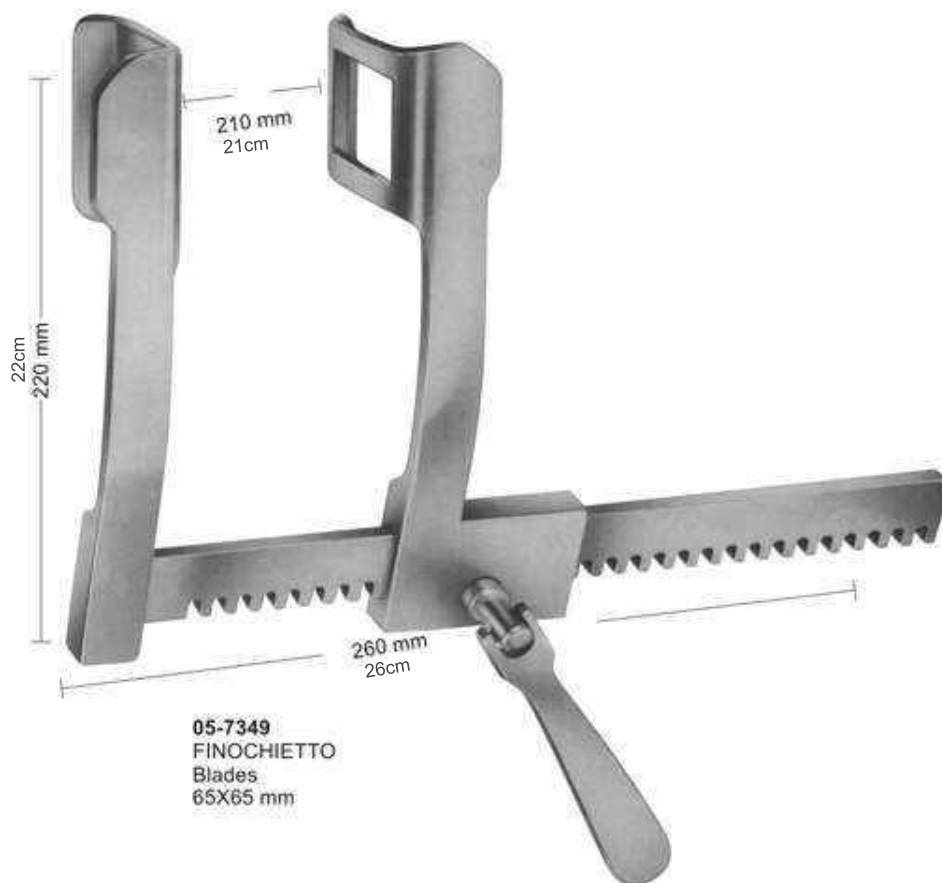
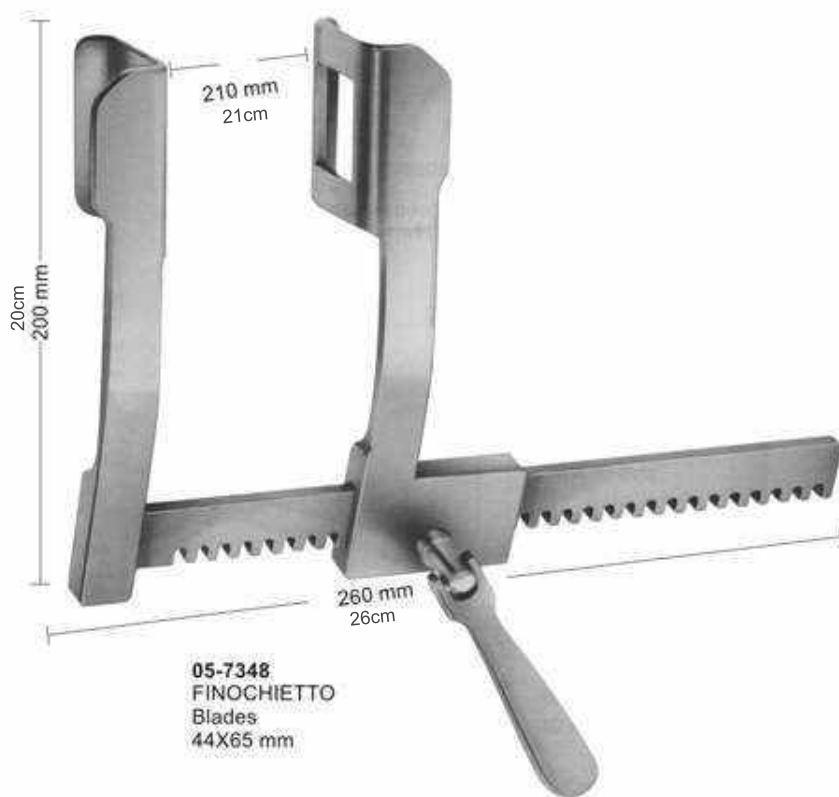

Rib Spreaders

05-7351
 Blades
 30x80 mm



05-7352
 Blades
 40x67 mm



05-7353
 Blades
 80x67 mm



220 mm
 22cm

22cm

220 mm

05-7354
 Blade, Only, for preparation
 of a. Mammaria, 25.5x80mm



300 mm
 30cm

05-7350
FINOCHIETTO-BURFORD
 with 2 pairs of blades
 (05-7352 - 05-7353)

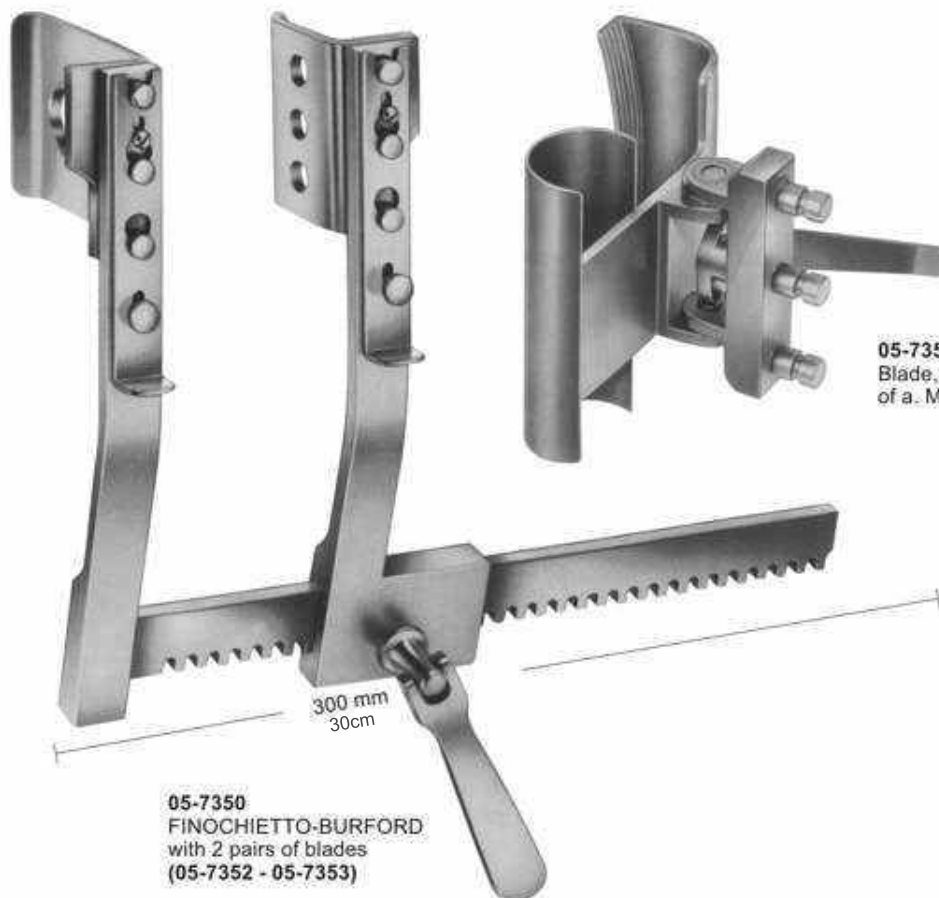

Rib Spreaders

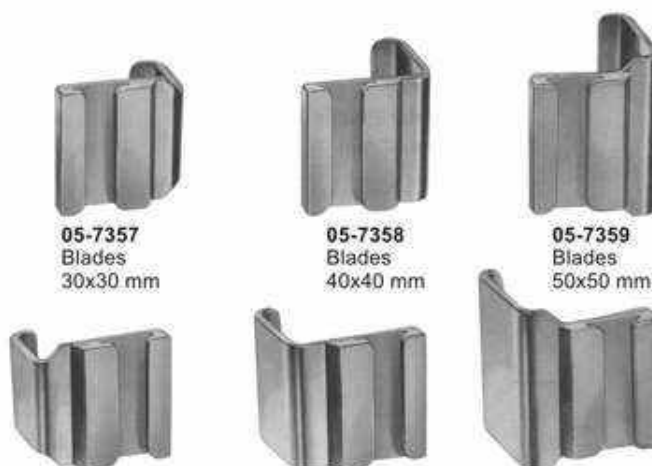
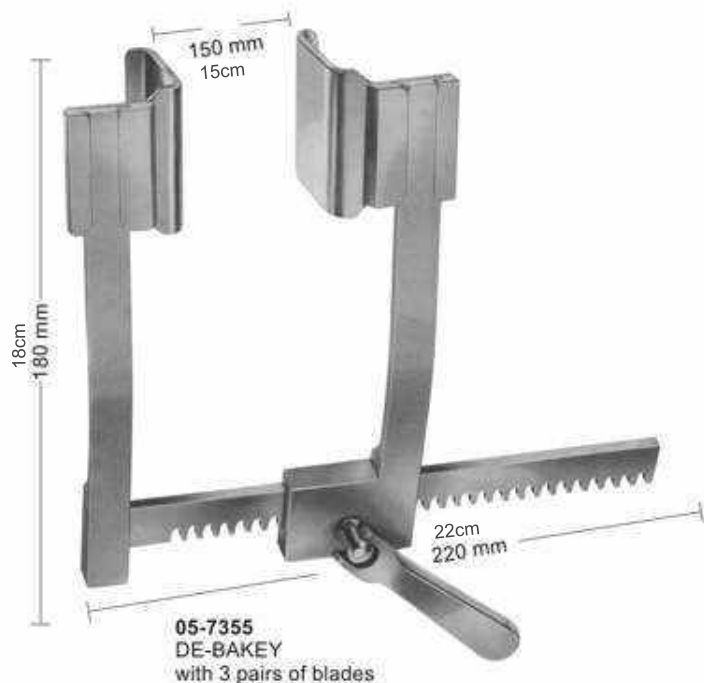

Components for **05-7355**
Spreader only Blades only
05-7357 30x30mm
05-7358 40x40mm
05-7359 50x50mm
The Blades are delivered in Pairs.

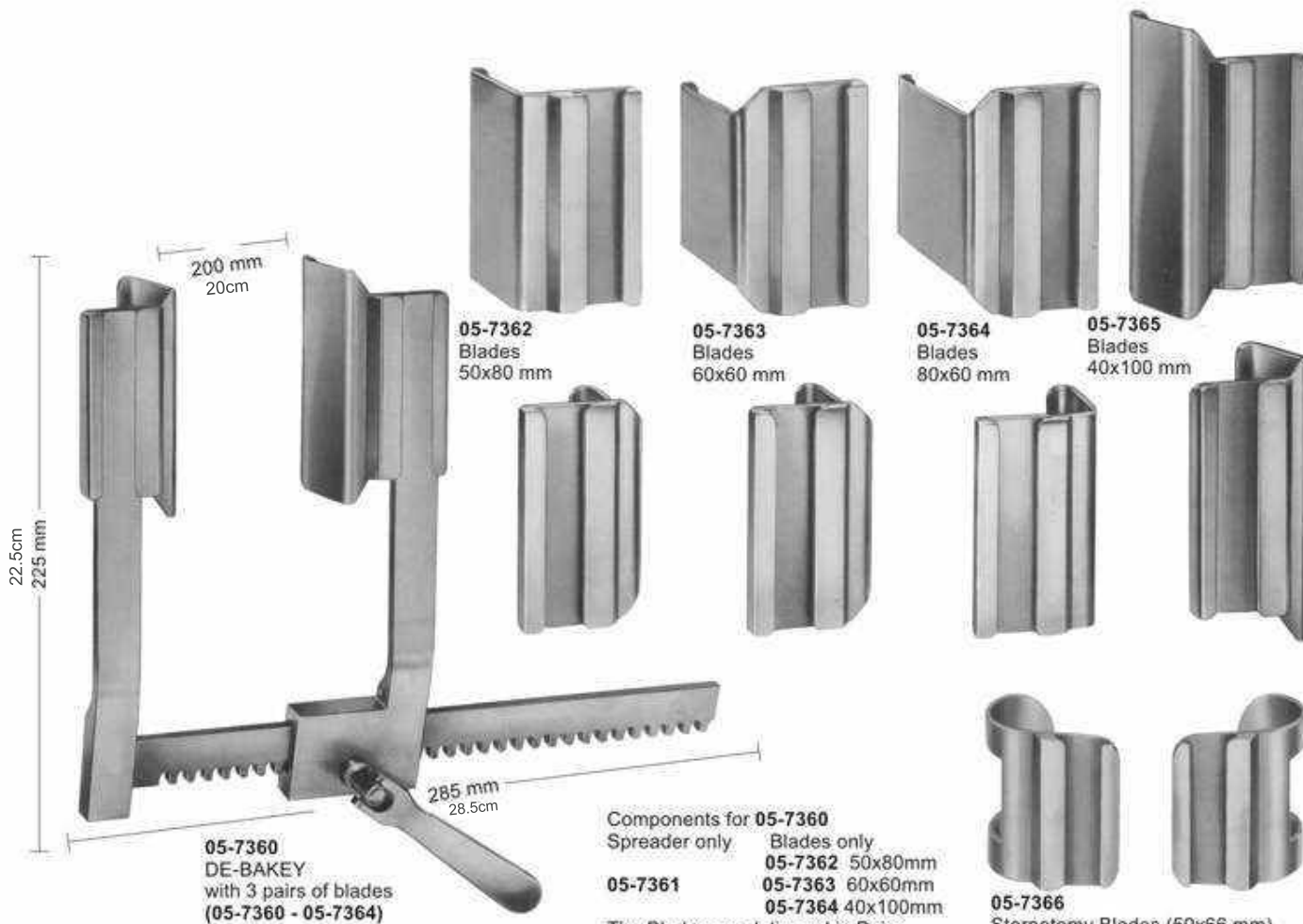

Components for **05-7360**
Spreader only Blades only
05-7362 50x80mm
05-7363 60x60mm
05-7364 40x100mm
The Blades are delivered in Pairs.

Sternotomy Spreaders

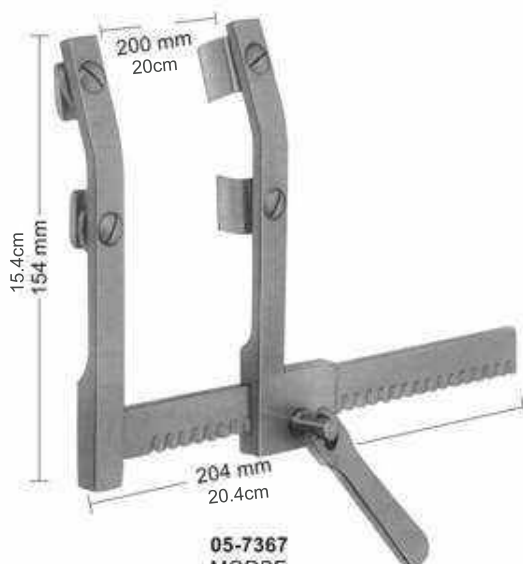

05-7367
MORSE
 Sternotomy spreader
 for children, with moveable
 double, blades each blade
 12x20 mm

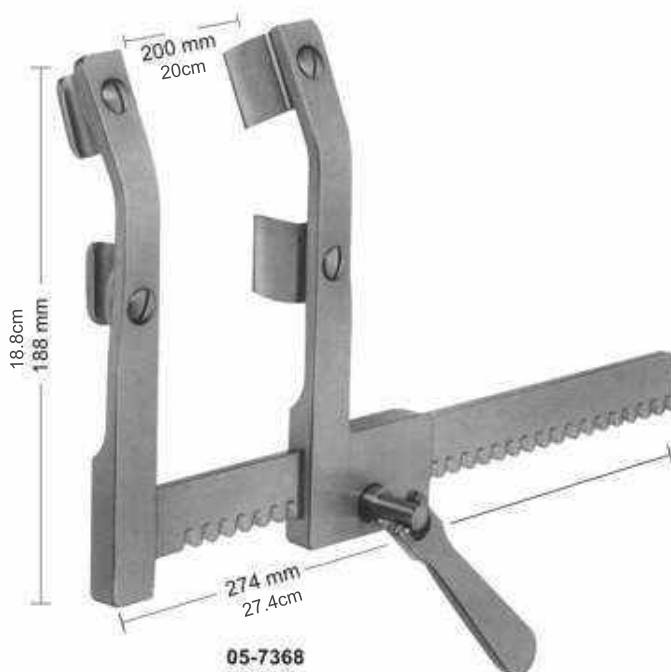

05-7368
MORSE
 Sternotomy spreader
 for adults, with moveable
 double, blades each blade
 19x19 mm

Rib Spreaders-and Contractors



05-7374
SELLORS
 Rib spreader-and contractor
 with swivel blades
 200 mm
 20cm
 8 Inch



05-7375
BAILEY
 150 mm
 15cm
 6 Inch



05-7376
 for children

05-7377
 for adults

05-7376 - 05-7377
BAILEY
 200 mm
 20cm
 8 Inch

Retractors, Lung Spatulas

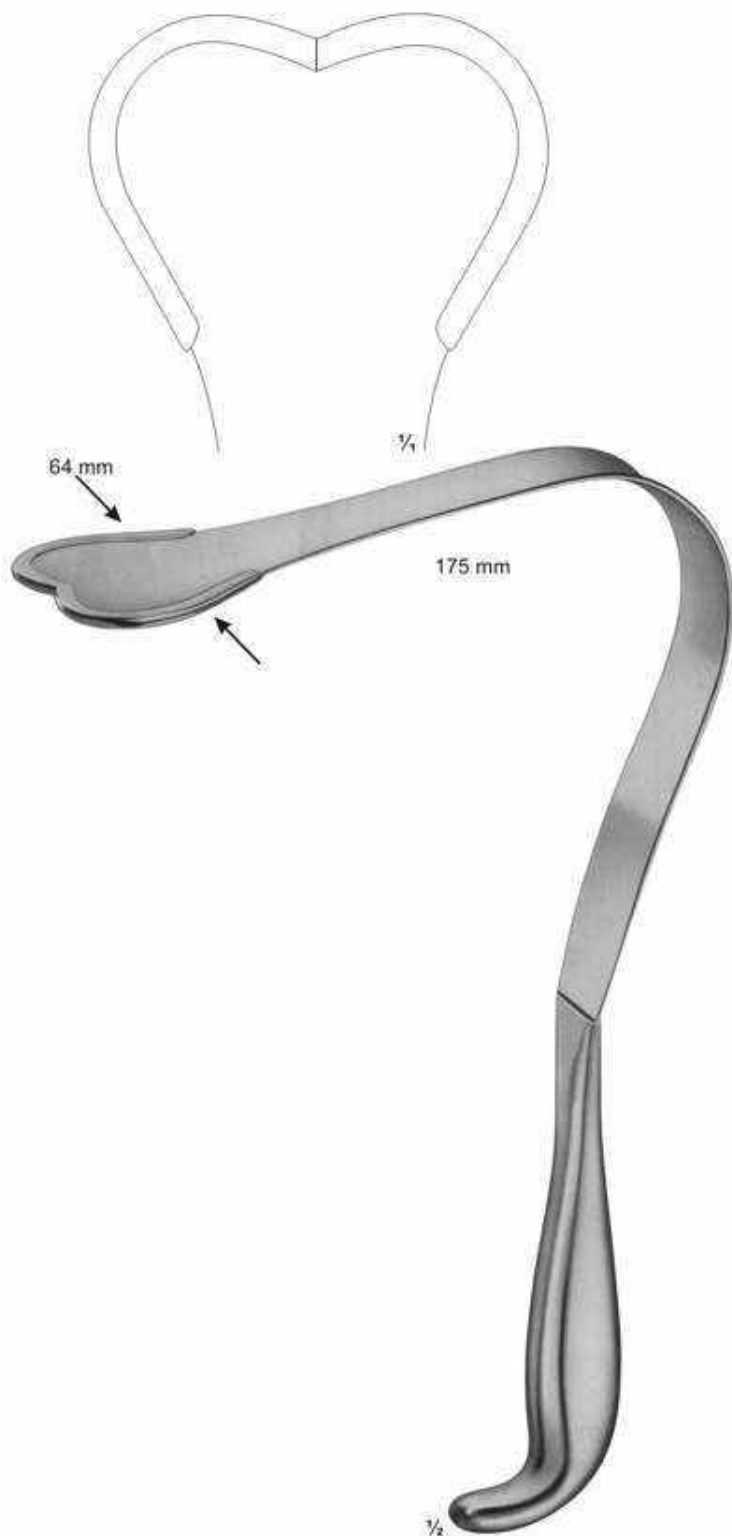

05-7378
HARRINGTON-PEMBERTON
 flexible
 295 mm
 29.5cm
 12 Inch

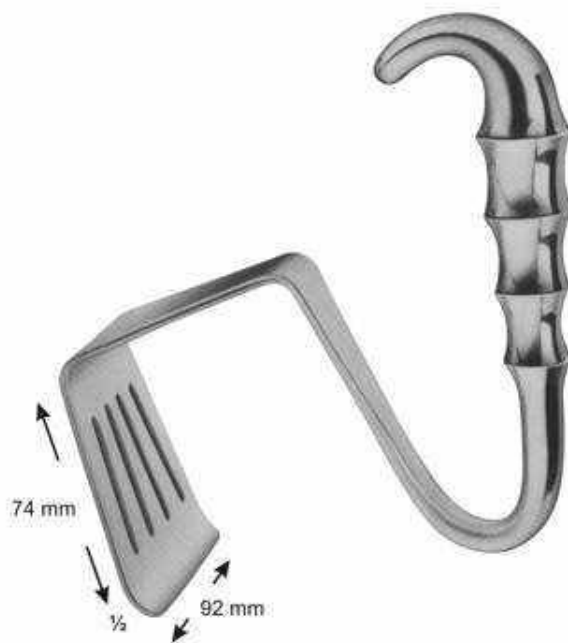

05-7379
DAVIDSON
 Scapula retractor

Lung Spatulas, Suction Cannulae

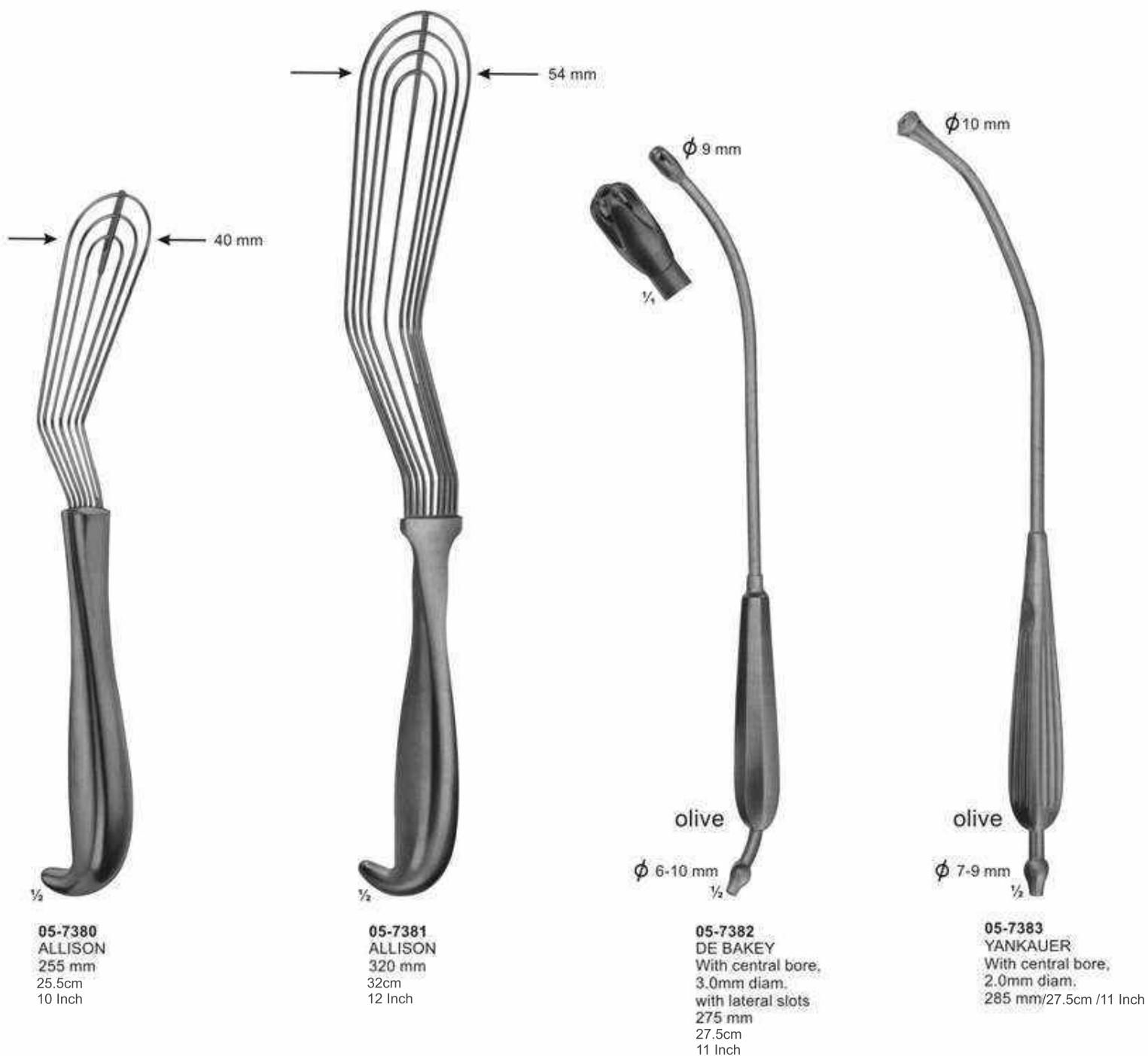

05-7380
ALLISON
 255 mm
 25.5cm
 10 Inch

05-7381
ALLISON
 320 mm
 32cm
 12 Inch

05-7382
DE BAKY
 With central bore,
 3.0mm diam.
 with lateral slots
 275 mm
 27.5cm
 11 Inch

05-7383
YANKAUER
 With central bore,
 2.0mm diam.
 285 mm/27.5cm /11 Inch

Punches

Angled positions for punchus

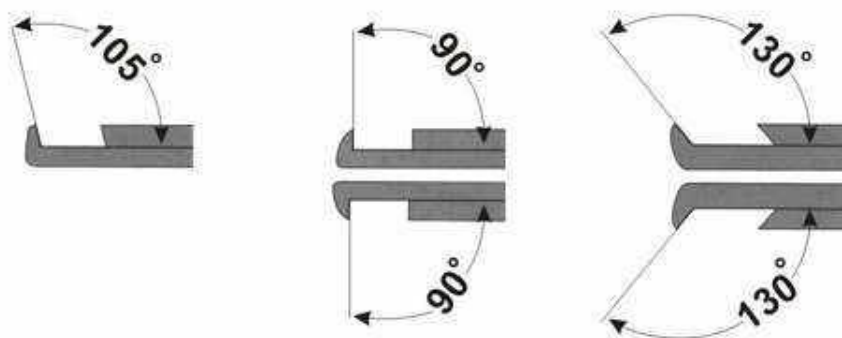

90° upwards cutting



05-7384 - 05-7385
 CITELLI
 05-7384 2mm
 05-7385 3.5mm

90° upwards cutting

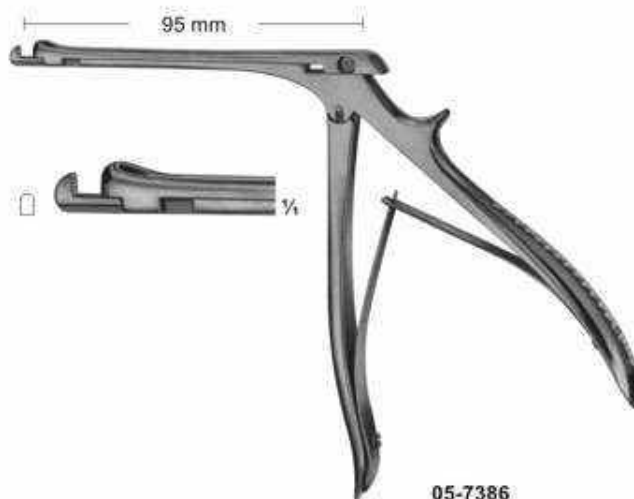

05-7386
 CITELLI-BEYER
 1,8 mm

Punches

90° upwards cutting

05-7387
4 mm



1/4

05-7388
5 mm



1/4

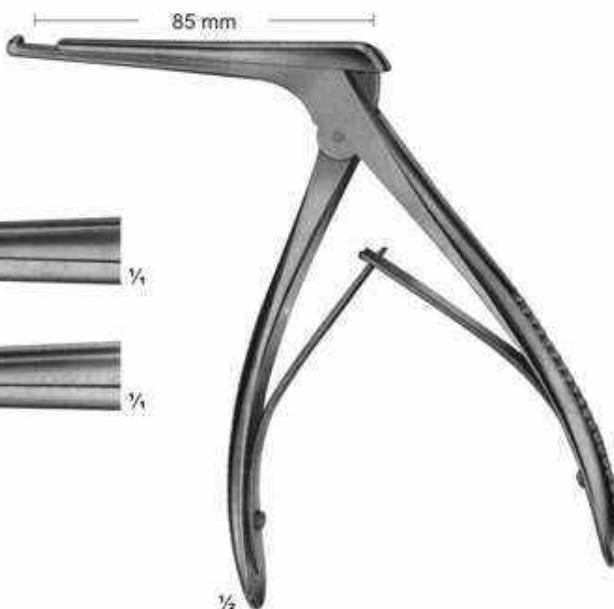

05-7387 - 05-7388
KERRISON

90° upwards cutting

05-7389
3,3 mm



1/4

05-7390
4,0 mm



1/4

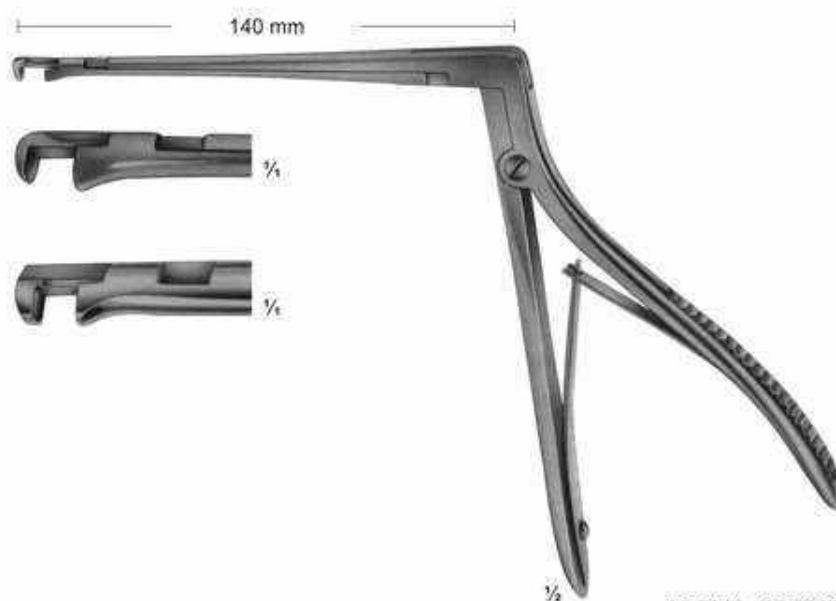

05-7389 - 05-7390
HAJEK-KOFLER

Punches

130° upwards cutting

KERRISON-JACOBY

05-7391
1 mm 

FERRIS-SMITH-KERRISON

05-7392
2 mm 

05-7393
3 mm 

05-7394
4 mm 

05-7395
5 mm 

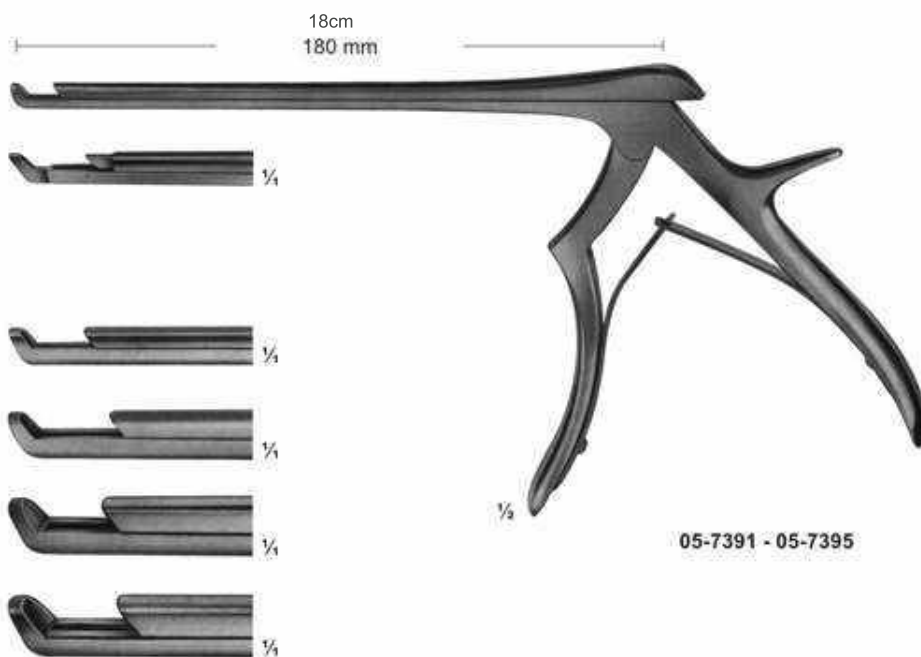

90° upwards cutting

KERRISON-JACOBY

05-7396
1 mm 

05-7397
2 mm 

FERRIS-SMITH-KERRISON

05-7398
3 mm 

05-7399
4 mm 

05-7400
5 mm 

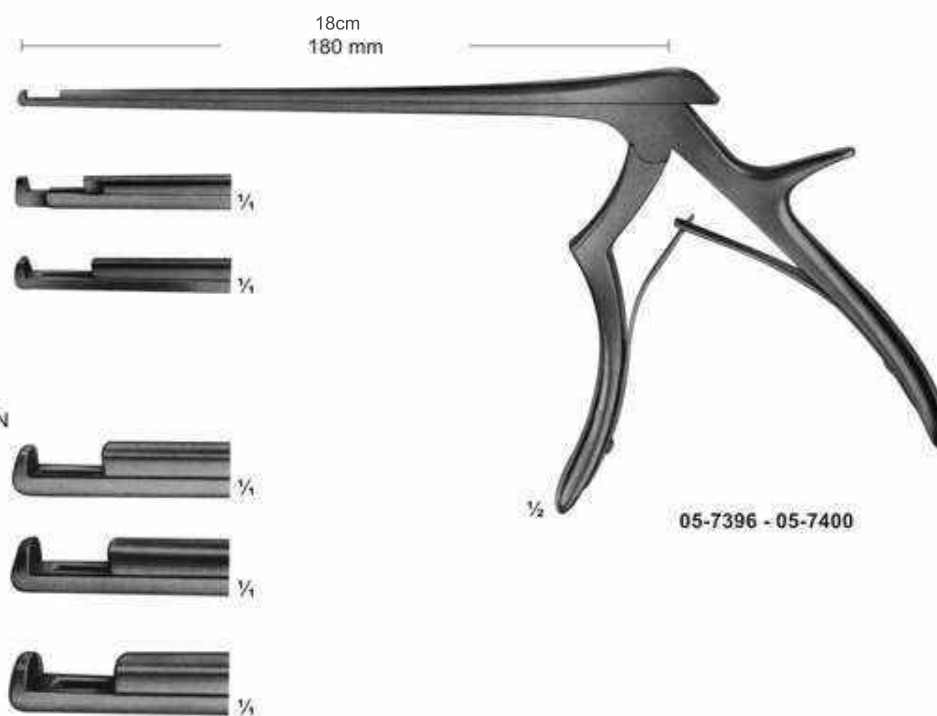

Rongeurs

Angled positions for rongeurs

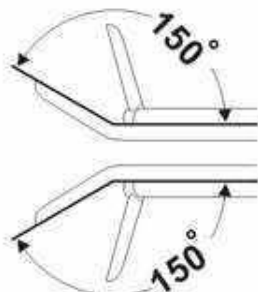

05-7401
3,0 mm

05-7402
3,6 mm

05-7403
4,2 mm

05-7404
4,8 mm

05-7405
5,8 mm

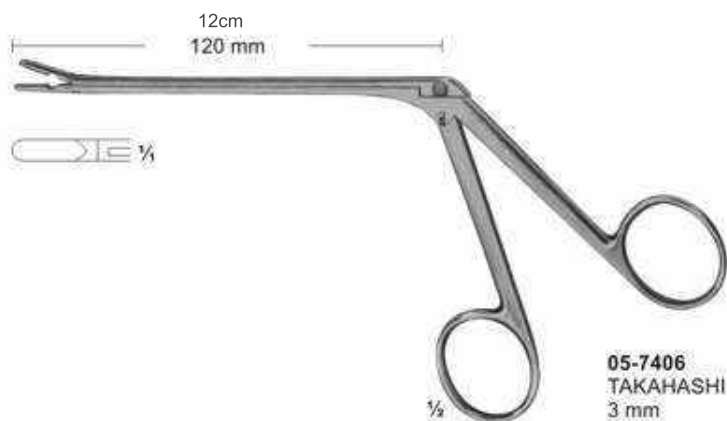
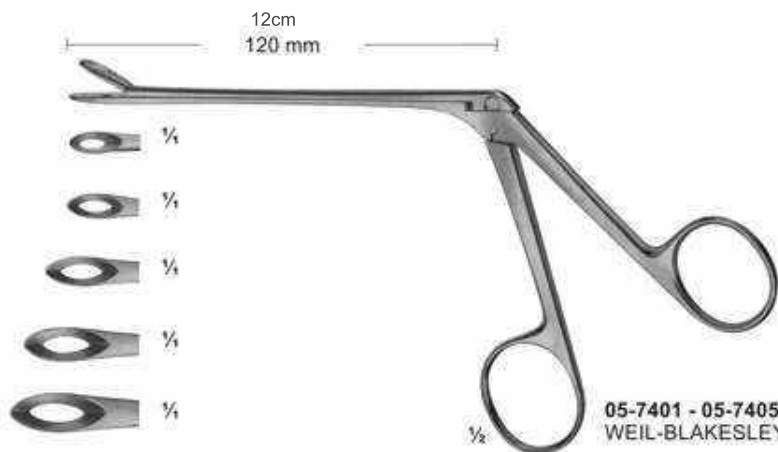
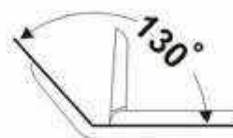
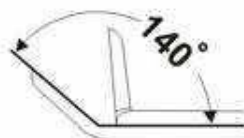

130°

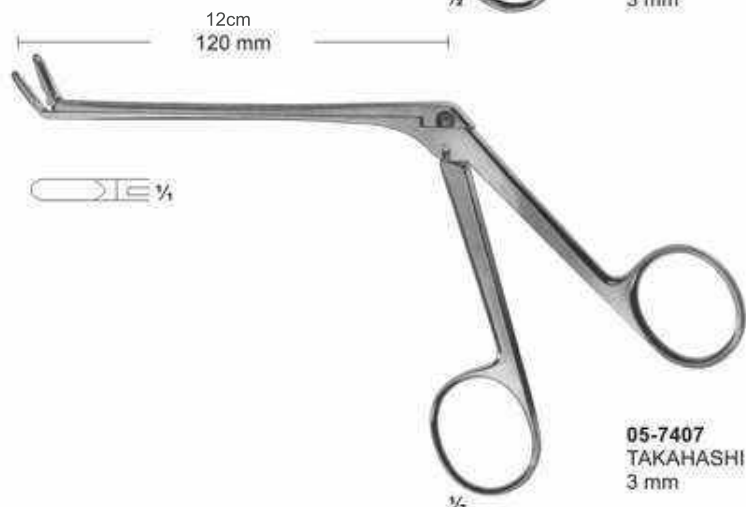

Rongeurs

LOVE-GRUENWALD

05-7408
 2 X 10 mm

05-7409
 3 X 10 mm

SPURLING

05-7410
 4 X 10 mm



05-7411
 2 mm

05-7412
 3 mm

05-7413
 4 mm

05-7414
 5 mm



150°

05-7415
 2 mm

05-7416
 3 mm

05-7417
 4 mm

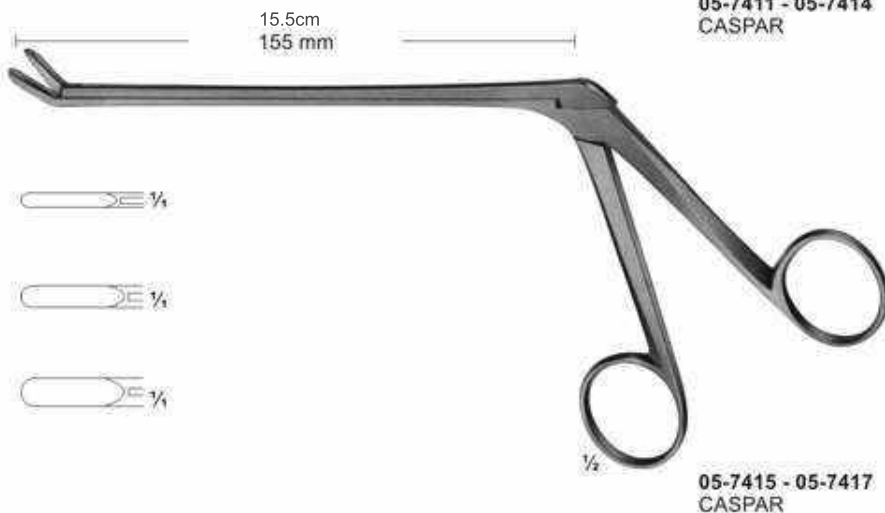

Rongeurs

150°

Lower part of jaws movable

05-7418
2 mm

05-7419
3 mm

05-7420
4 mm



05-7418 - 05-7420
CASPAR

Length of shaft 140 mm	Length of shaft 160 mm	Length of shaft 185 mm	size of jaws
05-7421	05-7426	05-7431	2 X12 mm
05-7422	05-7427	05-7432	3 X12 mm
05-7423	05-7428	05-7433	4 X14 mm
05-7424	05-7429	05-7434	5 X14 mm
05-7425	05-7430	05-7435	6 X16 mm

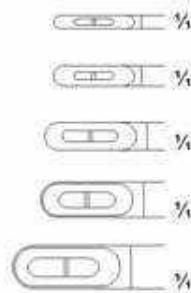

05-7421 - 05-7435
CASPAR

150°

Length of shaft 140 mm	Length of shaft 160 mm	Length of shaft 185 mm	size of jaws
05-7436	05-7439	05-7442	3 X12 mm
05-7437	05-7440	05-7443	4 X14 mm
05-7438	05-7441	05-7444	5 X14 mm

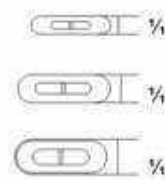

05-7436 - 05-7444
CASPAR



Rongeurs

150°

Lower part of jaw movable

Length of shaft 140 mm	Length of shaft 160 mm	Length of shaft 185 mm	size of jaws
05-7445	05-7447	05-7449	3 X 12 mm
05-7446	05-7448	05-7450	4 X 14 mm

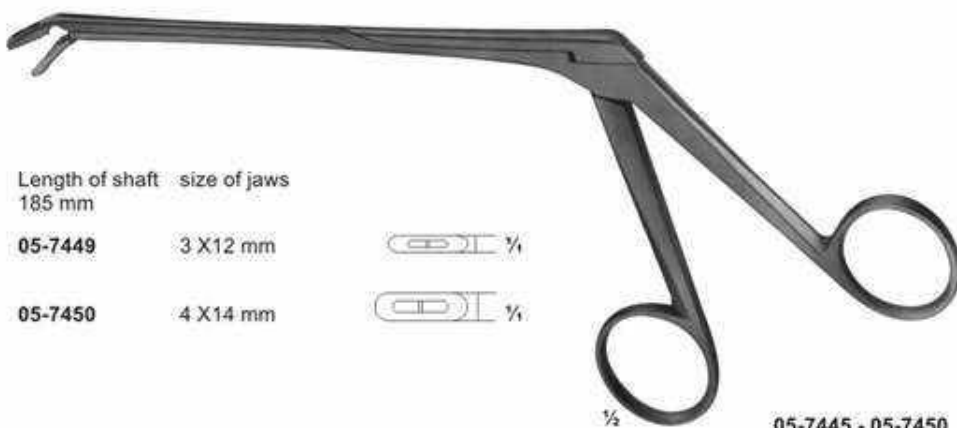

05-7445 - 05-7450
CASPAR

05-7451
2 X 10 mm
CUSHING



05-7452
3 X 10 mm
LOVE-GRUENWALD



05-7453
4 X 10 mm
SPURLING

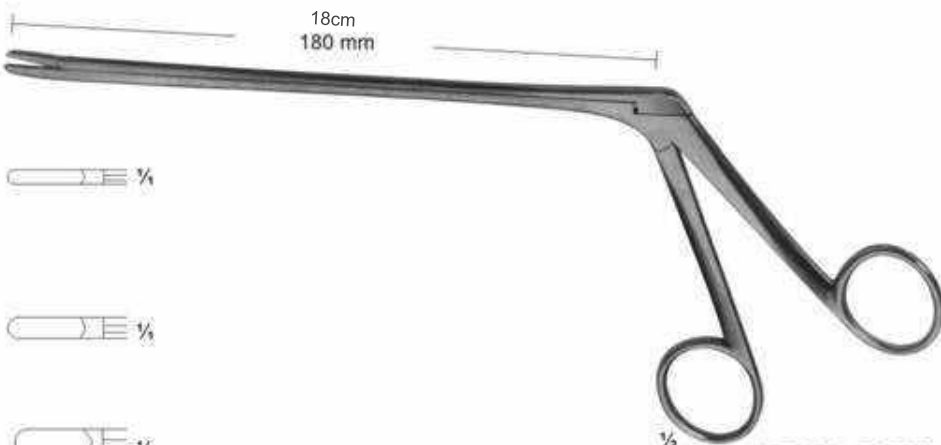

05-7451 - 05-7453

150°

05-7454
3 X 10 mm
LOVE-GRUENWALD



05-7455
4 X 10 mm
SPURLING



05-7454 - 05-7455



Rongeurs

150°

Upper part of jaw
movable

05-7456
3 X 10 mm
LOVE-GRUENWALD

05-7457
4 X 10 mm
SPURLING

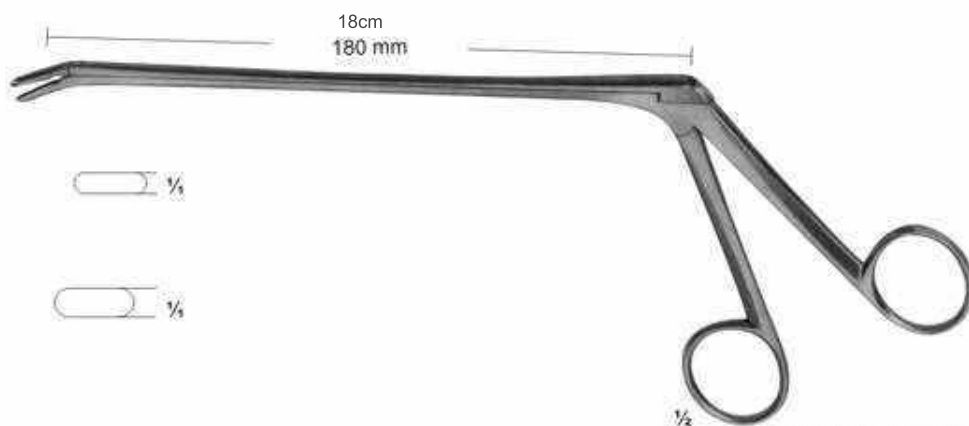

05-7456 - 05-7457

05-7458
∅ 7 mm

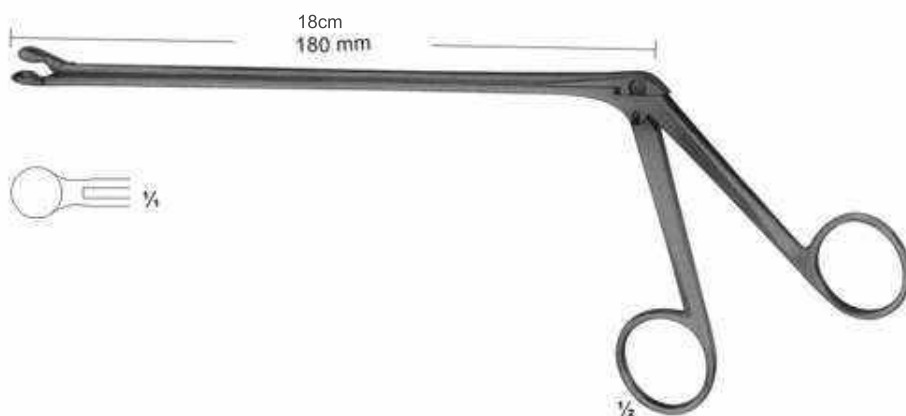

05-7458
OLDBERG

05-7459
YASARGIL
∅ 2,2 mm

05-7460
YASARGIL
∅ 3,5 mm



05-7459 - 05-7460

Rongeurs

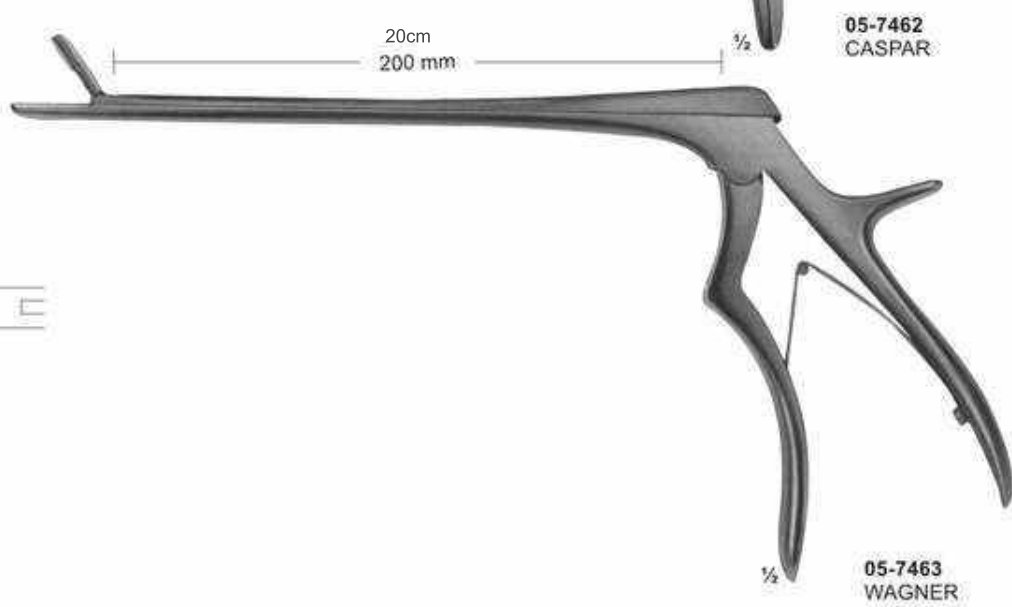
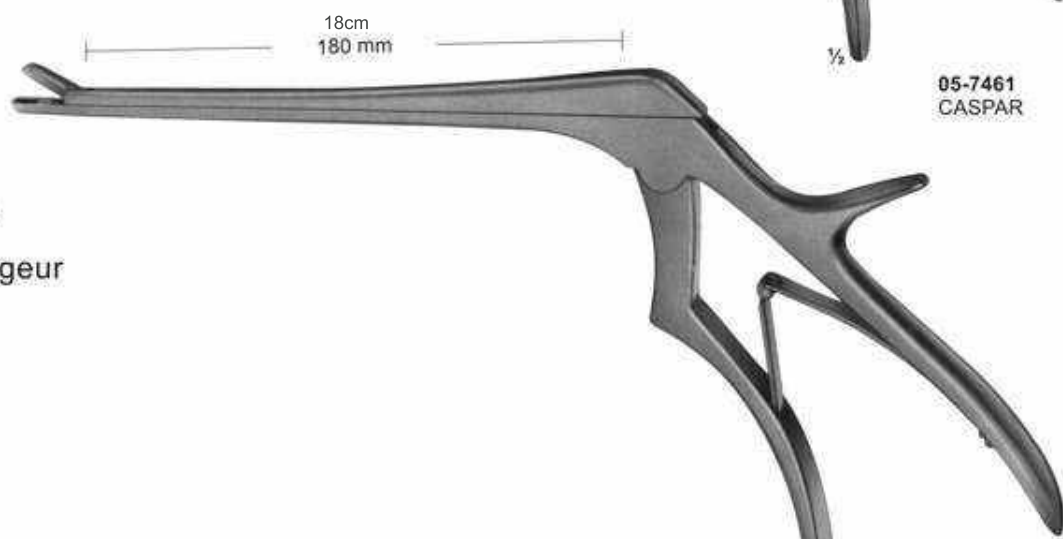
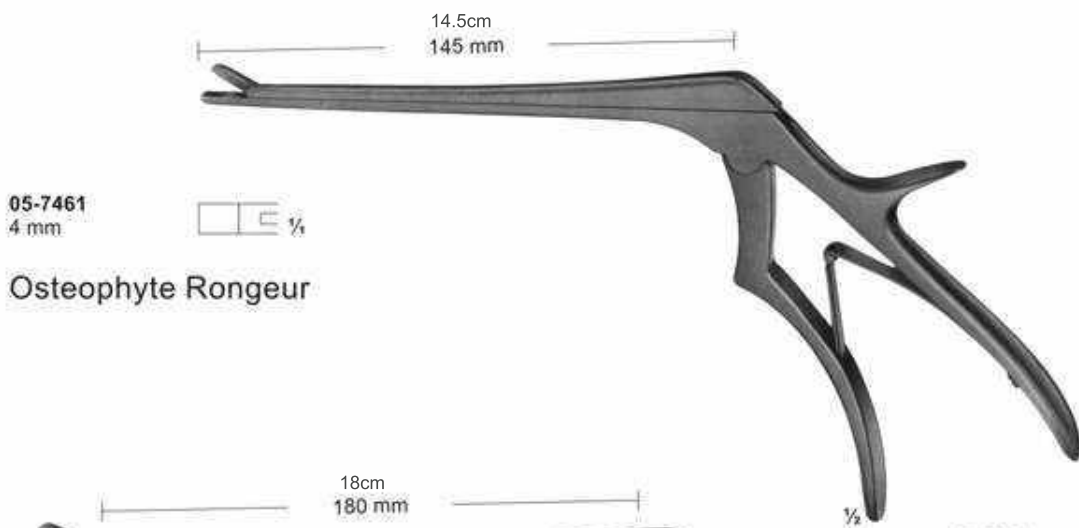

05-7461
CASPAR

05-7462
CASPAR

05-7463
WAGNER

Amputation and Resection Knives



Amputation Retractors

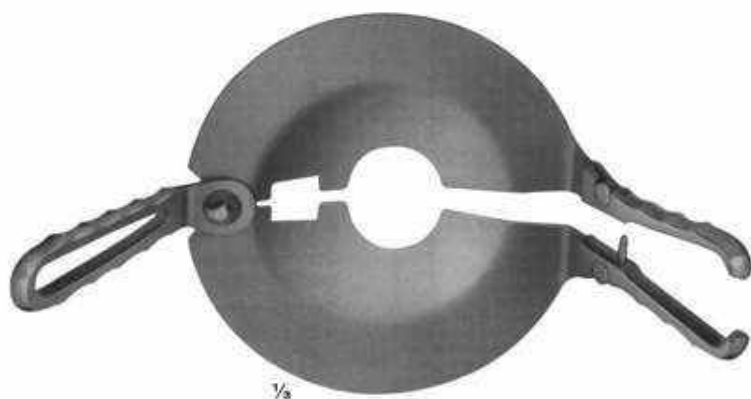

06-8006
PERCY
removeable handles

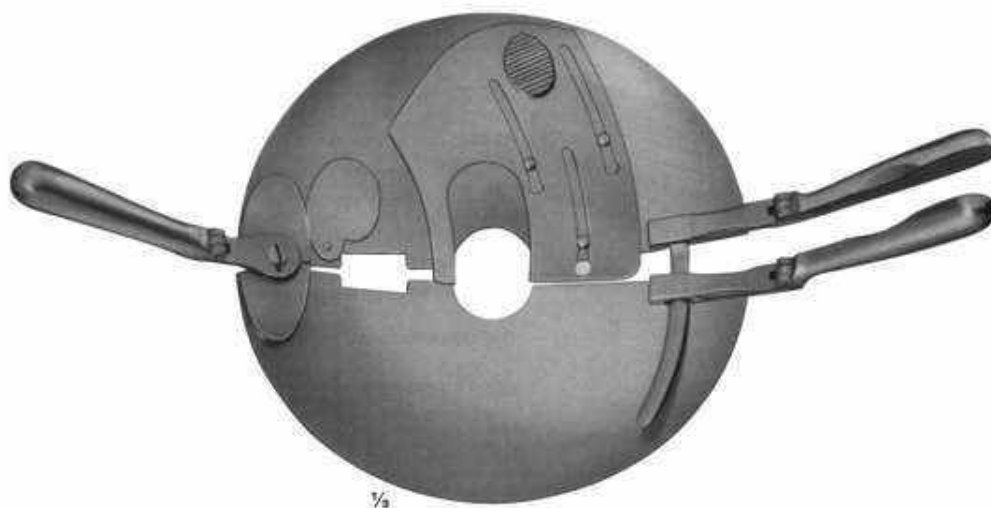

06-8007
PERCY
reversible handles

Amputation Saws



06-8008
CHARRIERE
 Length of blade
 215 mm / 21.5cm
 complete with one saw
 blade each (**06-8009** and **06-8010**)
 350 mm / 35cm / 14 Inch

Spare saw blades, carbon steel
06-8009 12 mm
06-8010 20 mm



06-8011
RUST
 Length of blade
 235 mm
 complete with one saw
 blade each (**06-8013**, **06-8014**
 and 2 saw blades **06-8015**)
 390 mm / 39cm / 15 Inch
06-8012 Bow only

Spare saw blades, carbon steel
06-8013 6 mm
06-8014 8 mm
06-8015 12 mm
06-8016 20 mm

Amputation Saws

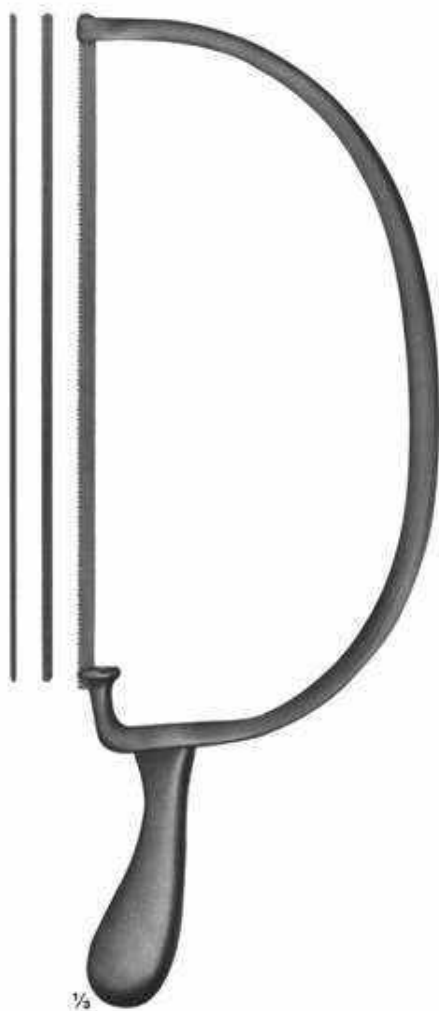

1/3

06-8017
BIER
 Length of blade:
 270 mm /27cm /11 Inch
 complete with one saw
 blade each(**06-8018**, **06-8019** and **06-8020**)
 420 mm /42cm /17 Inch

Spare saw blades, carbon steel
06-8018 4 mm
06-8019 6 mm
06-8020 8 mm



1/3

06-8021
CHARRIERE
 Length of blade:
 180 mm /18cm /7 Inch
 Spare saw blade,
 carbon steel(**06-8022**)
 270 mm /27cm /11 Inch

06-8023
CHARRIERE
 Length of blade
 240 mm /24cm /9 Inch
 Spare saw blade,
 carbon steel(**06-8024**)
 340 mm /34cm /13 Inch



1/3

06-8025
SATTERLEE
 Length of blade
 200 mm /20cm /8 Inch
 Spare saw blade,
 carbon steel(**06-8026**)
 200 mm /20cm /8 Inch



1/3

06-8027
LANGENBECK
 Length of blade
 115 mm /11.5cm /5 Inch
 Metacarpal saw
 235 mm /23.5cm /9 Inch

Wire Saws And Conductor

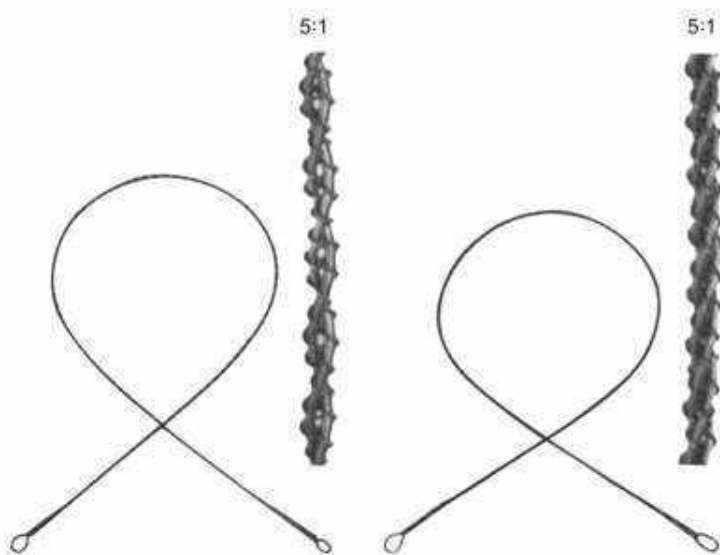

06-8028 - 06-8031

OLIVECRONA

06-8028 300 mm /30cm /12 Inch

06-8029 400 mm /40cm /16 Inch

06-8030 500 mm /50cm /20 Inch

06-8031 700 mm /70cm /28 Inch

06-8032 - 06-8035

GIGLI

06-8032 300 mm /30cm /12 Inch

06-8033 400 mm /40cm /16 Inch

06-8034 500 mm /50cm /20 Inch

fine, 6 wires twisted

06-8035 500mm

coarse, 4 wires twisted



06-8036

GIGLI

Handle



06-8037

LEBSCHE

Conductor for
 wire saws, malleable
 250 mm /25cm /10 Inch

Elevators and Bone Levers

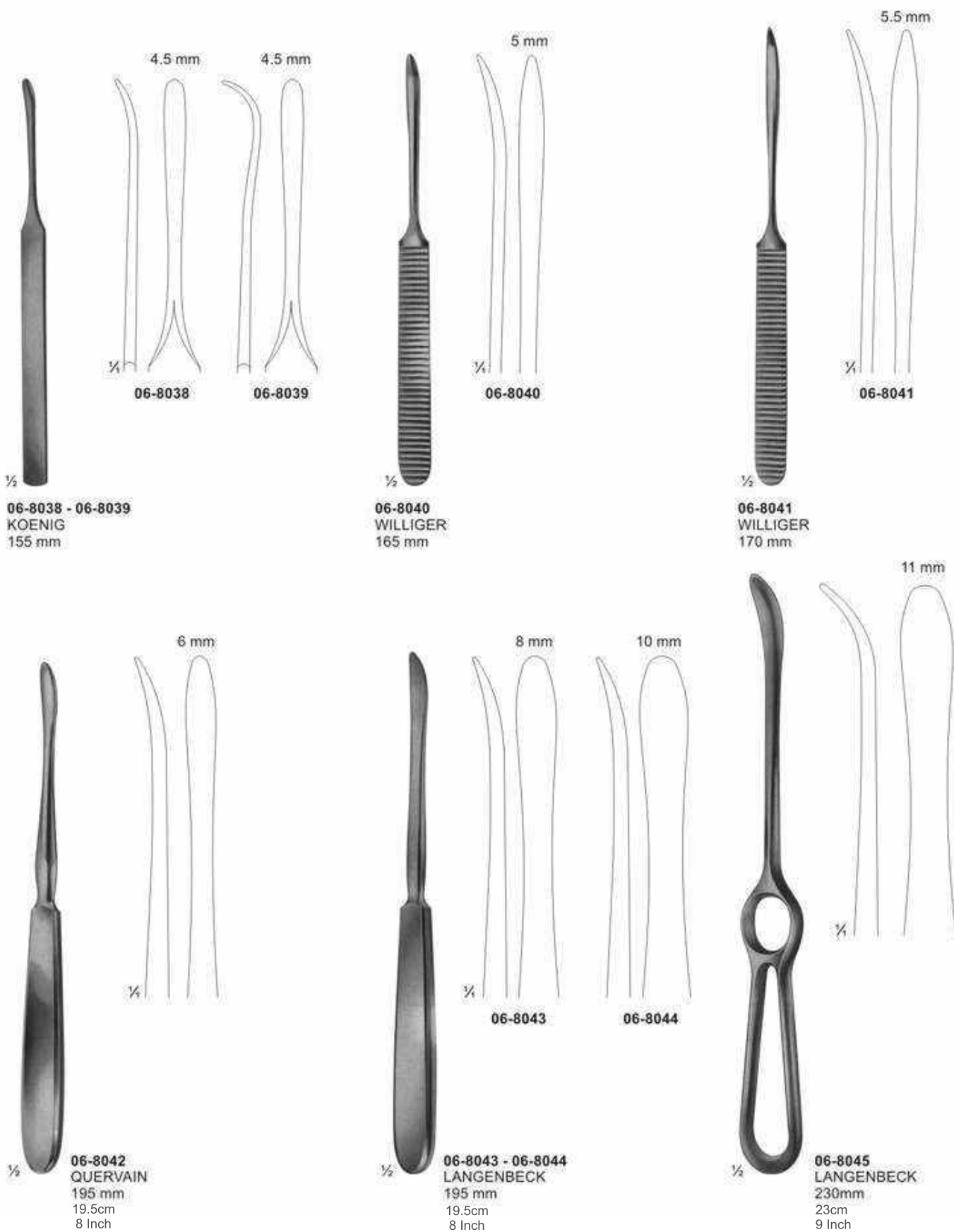

Bone Levers



06-8046
140mm
14cm
6 Inch



06-8047
150mm
15cm
6 Inch



06-8048
150mm
15cm
6 Inch

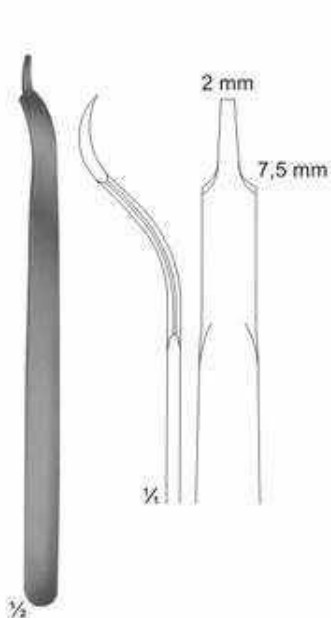

06-8049
BUCK-GRAMCKO
150mm
15cm
6 Inch



06-8050
160mm
16cm
6 Inch

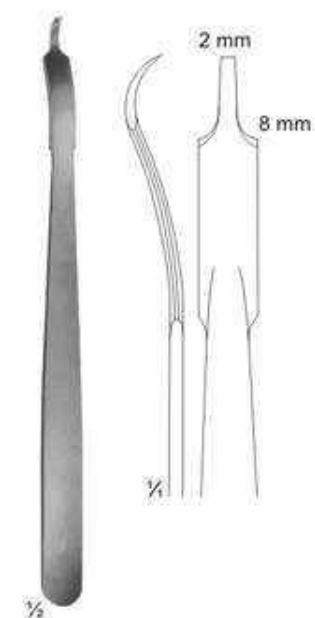

06-8051
160mm
16cm
6 Inch

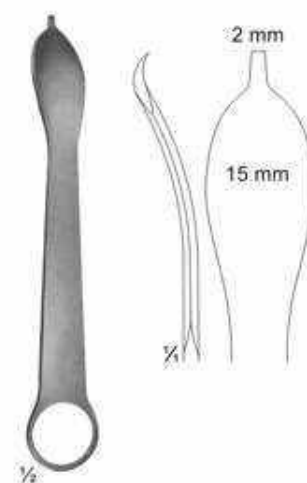

06-8052
125mm
12.5cm
5 Inch



Bone Levers



06-8053
LANE TRETHOWAN
215mm
21.5cm
8 Inch

06-8054
LANE
255mm
25.5cm
10 Inch

06-8055
LANGE-HOHMANN
250mm
25cm
10 Inch

06-8056 - 06-8057
LANGE-HOHMANN
modif
06-8056 265mm 26.5cm / 10 Inch
06-8057 280mm 28cm / 11 Inch



Bone Levers

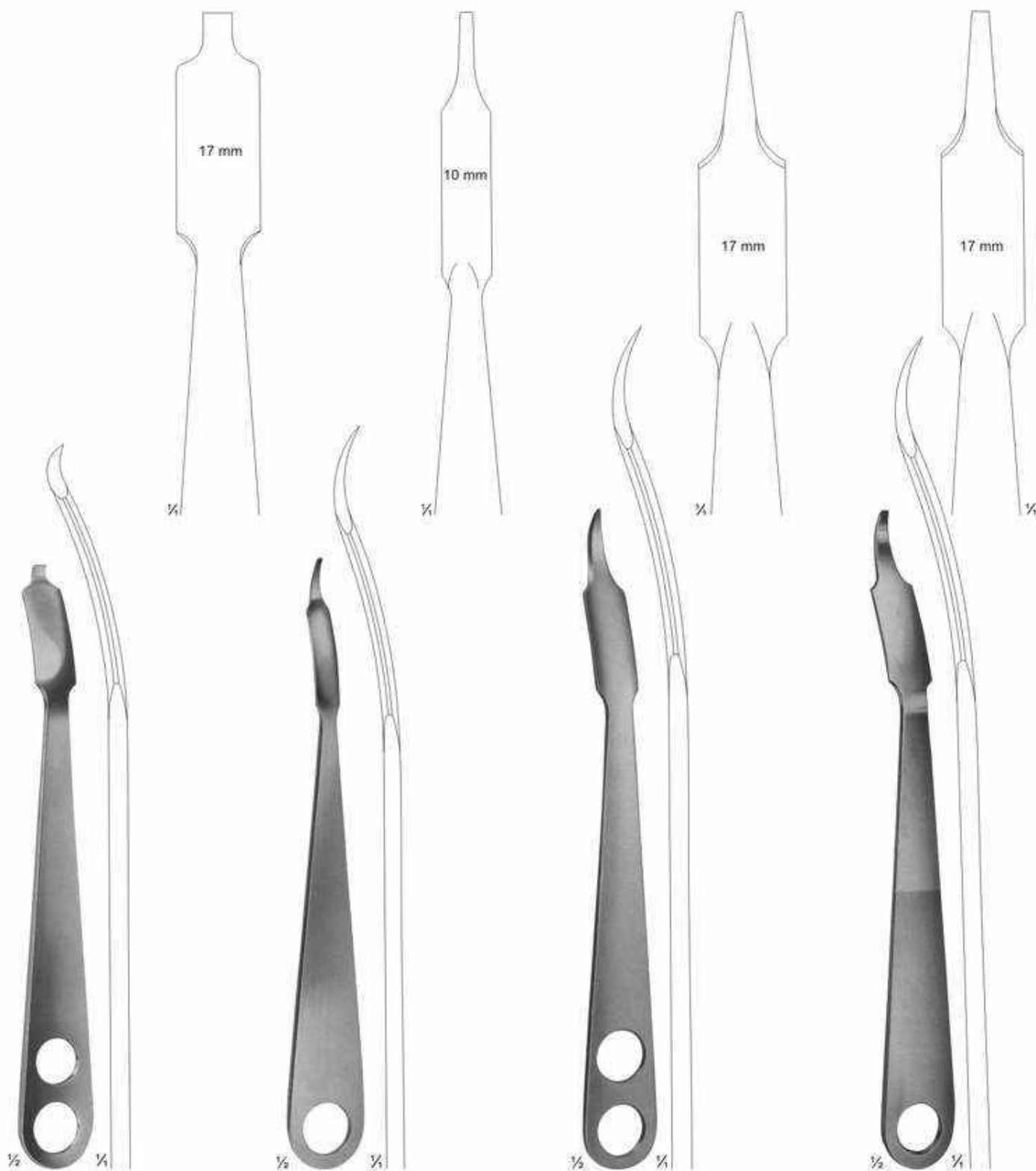

06-8058
WAGNER
220 mm
22cm
9 Inch

06-8059
220 mm
22cm
9 Inch

06-8060
240 mm
24cm
9 Inch

06-8061
240 mm
24cm
9 Inch

Bone Levers

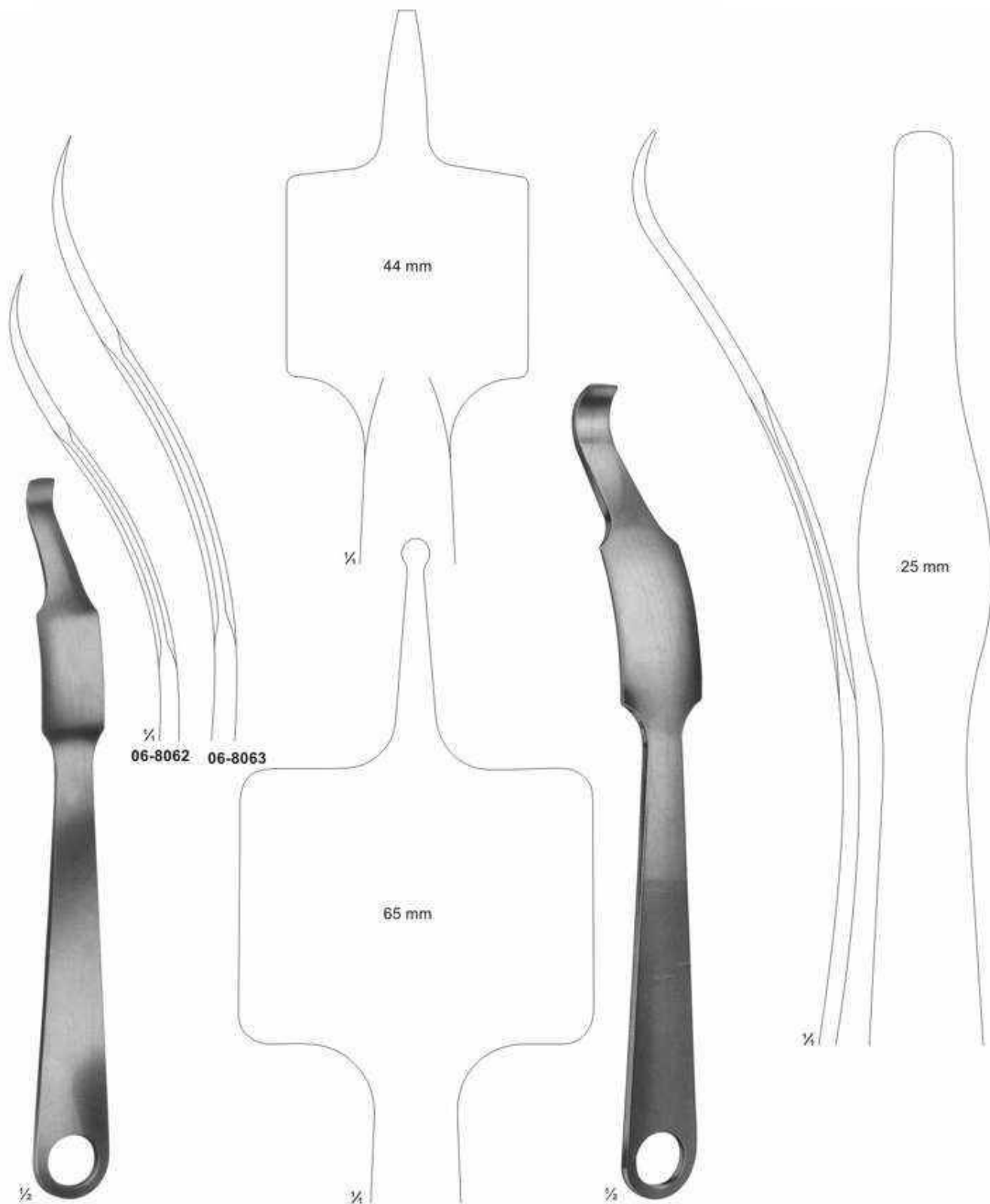

06-8062 - 06-8063
VERBRUGGE-MULLER
06-8062 240 mm /24cm /9 Inch
06-8063 255 mm

06-8064
 260 mm
 26cm
 10 Inch

Bone Levers

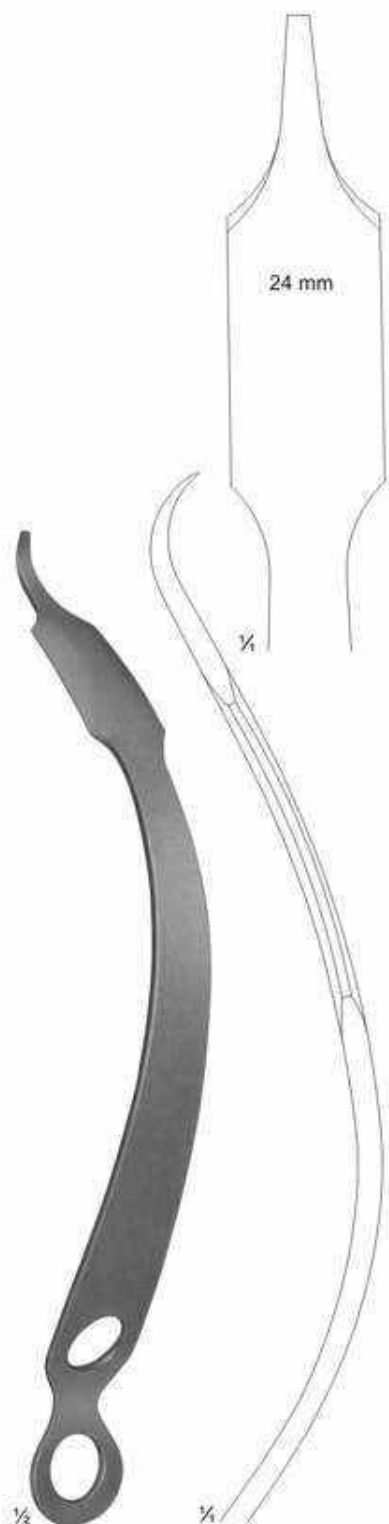

06-8065
 HOHMANN-ALDINGER
 270 mm / 27cm / 11 Inch



06-8066
 SCHUMACHER mod. WAGNER
 345 mm / 34.5cm / 14 Inch

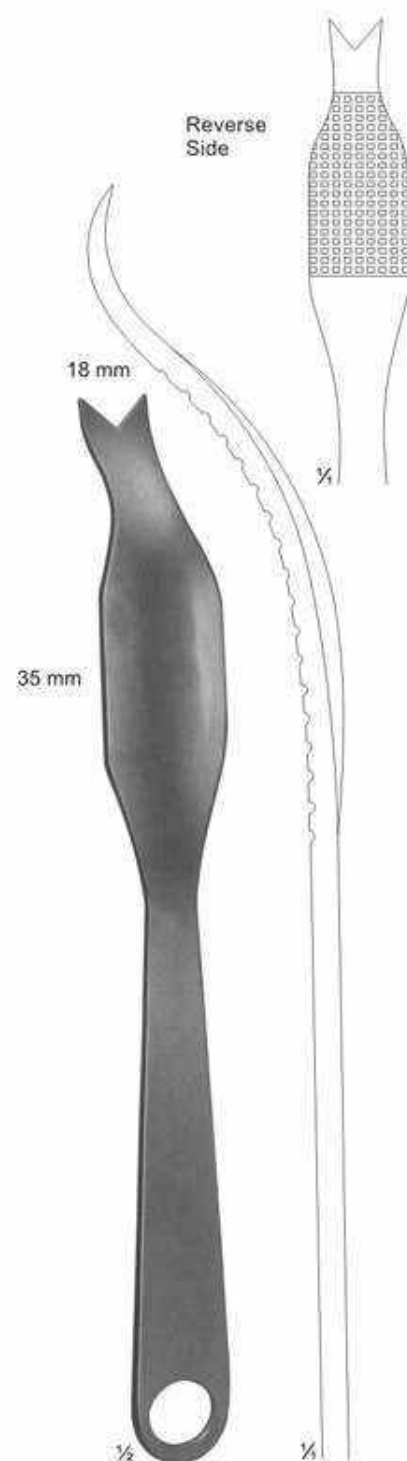

06-8067
 SCHUMACHER
 290 mm / 29cm / 11 Inch

Special Bone Levers



06-8068
TAGER
 Bone lever for
 angle joint operations
 175 mm / 17.5cm / 7 Inch



06-8069
BENNETT
 235 mm
 23.5cm
 9 Inch

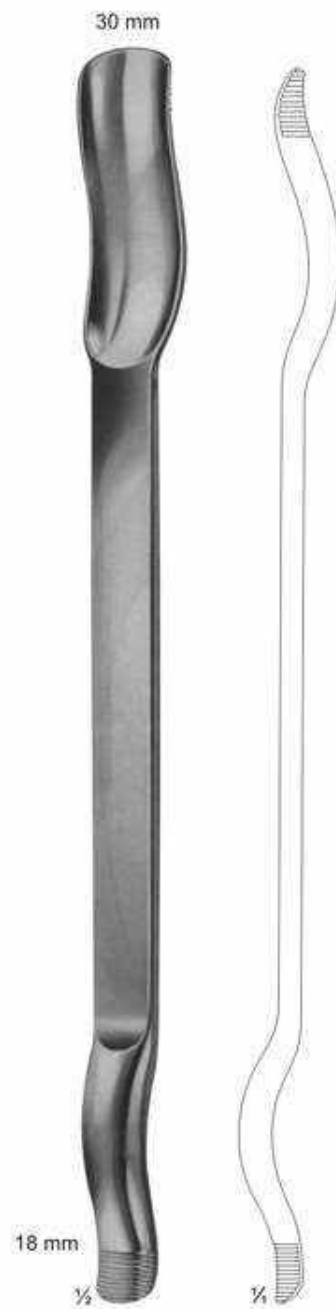

06-8070
MURPHY-LANE
 Luxation lever
 340 mm
 34cm
 13 Inch

Raspatories

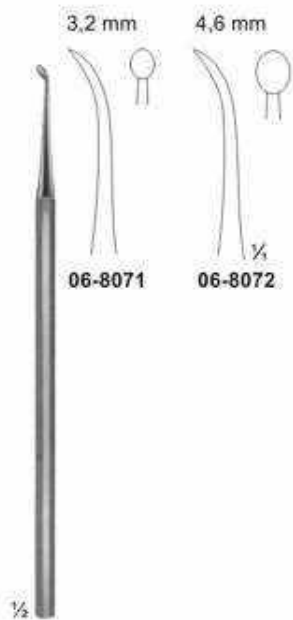

06-8071 - 06-8072
PARTSCH
150 mm
15cm
6 Inch



06-8073
PARTSCH mod. LANGE
145 mm
14.5cm
6 Inch



06-8074
MC KENTY
155 mm
15.5cm
6 Inch

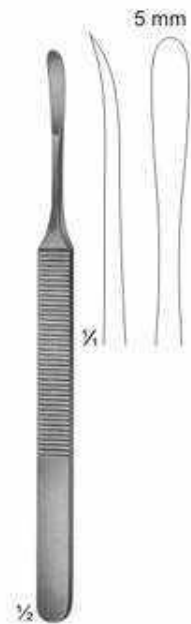

06-8075
KOENIG
155 mm
15.5cm
6 Inch

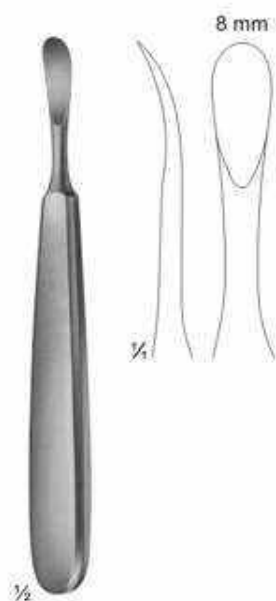

06-8076
TRELAT
150 mm
15cm
6 Inch



06-8077
WILLIGER
140 mm
14cm
6 Inch



06-8078
WILLIGER
160 mm
16cm
6 Inch



06-8079
JOSEPH
170 mm
17cm
7 Inch

Raspatories



06-8080
HALLE
 blunt
 180 mm / 18cm / 7 Inch



06-8081
FREER
 blunt
 190 mm / 19cm / 8 Inch



06-8082
FREER
 sharp
 190 mm / 19cm / 8 Inch



06-8083
SEWALL
 blunt
 200 mm / 20.5cm / 8 Inch



06-8084



06-8085



06-8086



06-8087



06-8088

06-8084 - 06-8086
PAULSEN
 205 mm
 20.5cm
 8 Inch

06-8087 - 06-8088
PAULSEN
 205 mm
 20.5cm
 8 Inch

Raspatories



06-8089
KILLIAN
sharp/blunt
185 mm / 18.5cm / 7 Inch



06-8090
HOWARTH
sharp/blunt
215 mm
21.5cm
8 Inch



06-8091
KILLIAN
sharp/blunt
185 mm / 18.5cm / 7 Inch



06-8092
MAC DONALD
blunt/blunt
185 mm
18.5cm
7 Inch



06-8093
FREER
sharp/blunt
185 mm
18.5cm
7 Inch

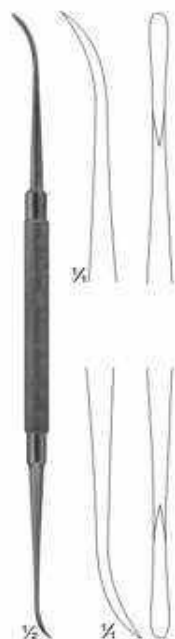

06-8094
FREER-YASARGIL
sharp/sharp
185 mm
18.5cm
7 Inch

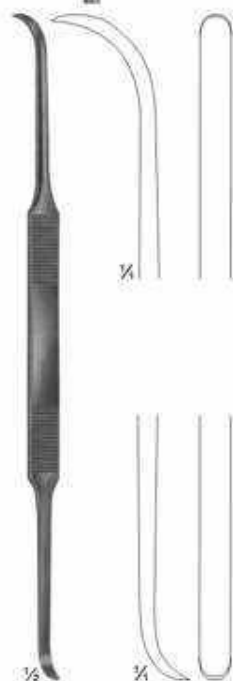

06-8095
COTTLE
sharp/sharp
200 mm
20cm
8 Inch



06-8096
MEAD
sharp/sharp
165 mm
16.5cm
6 Inch



06-8097
MOLT
sharp/sharp
180 mm
18cm
7 Inch

Raspatories

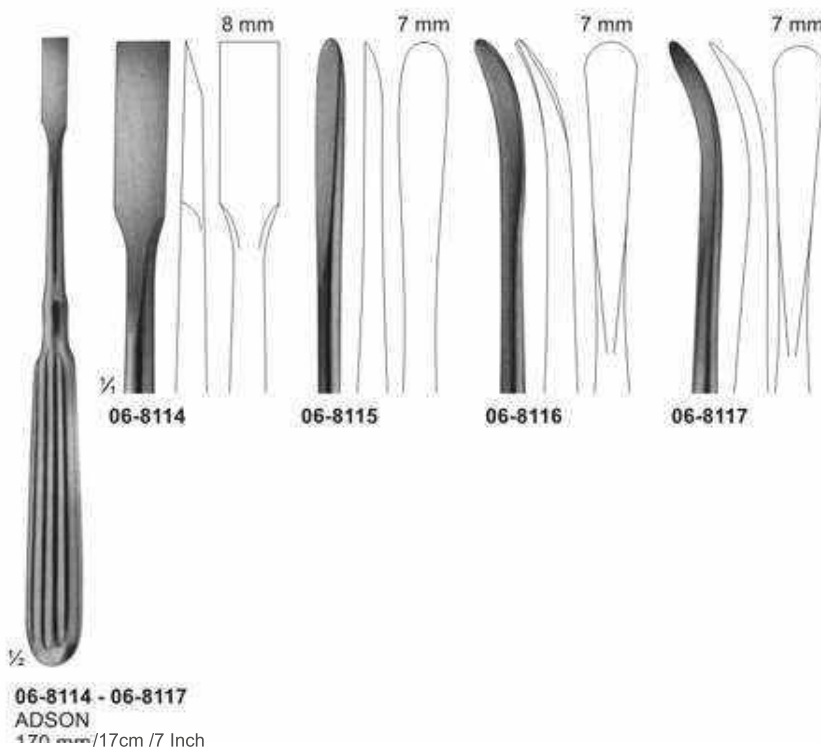
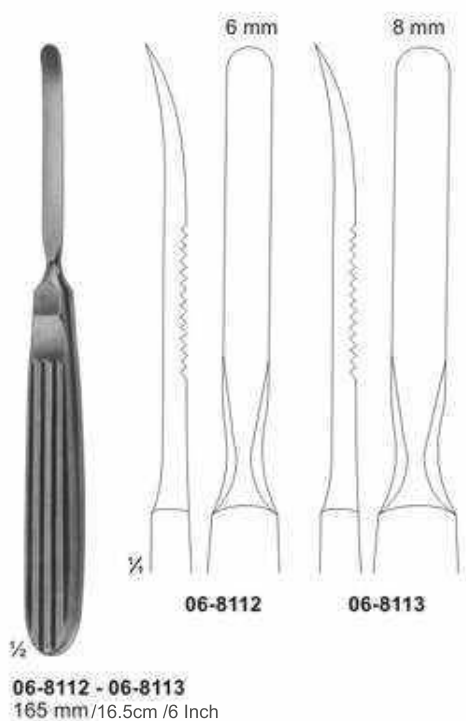
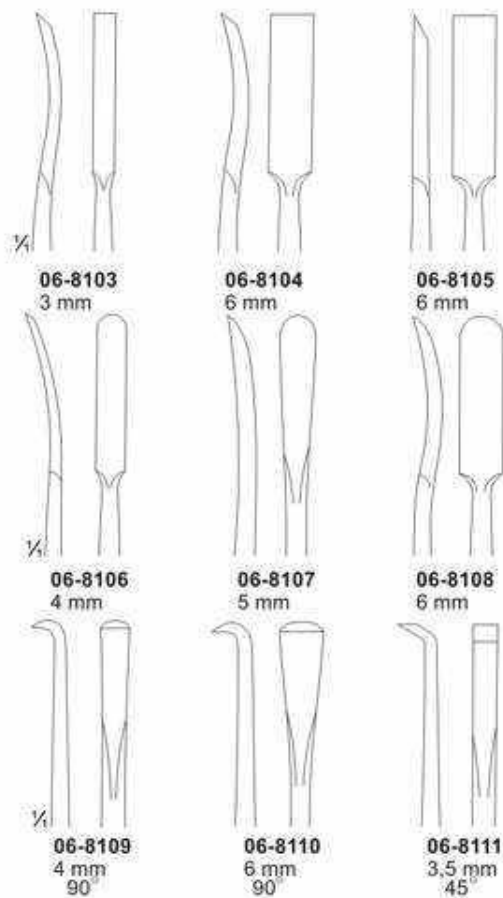
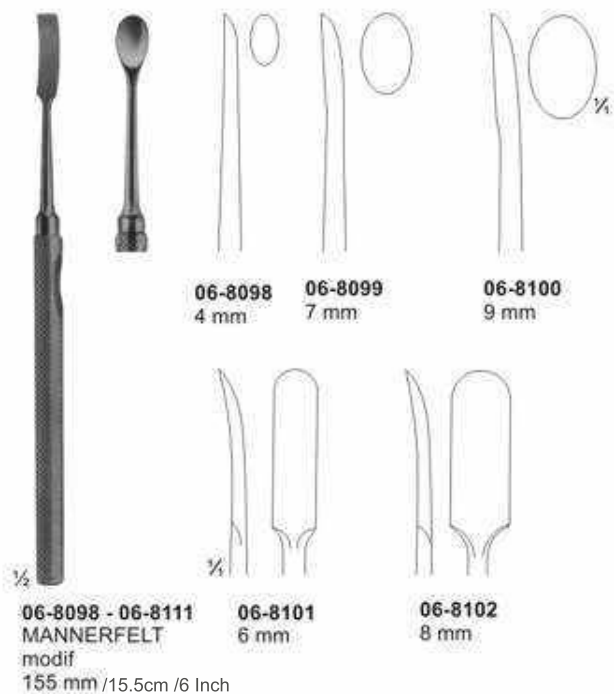

Raspatories

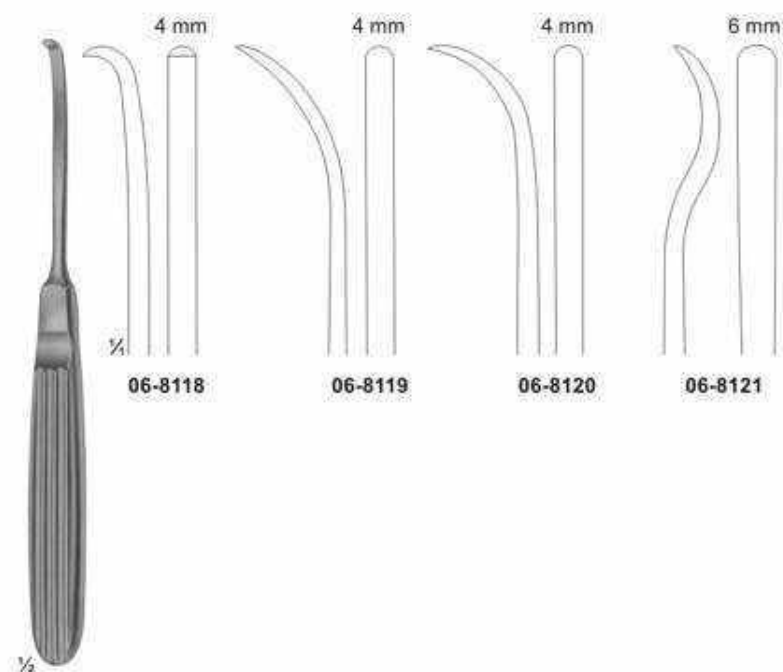

06-8118 - 06-8121
MUEHLING
170 mm
17cm
7 Inch

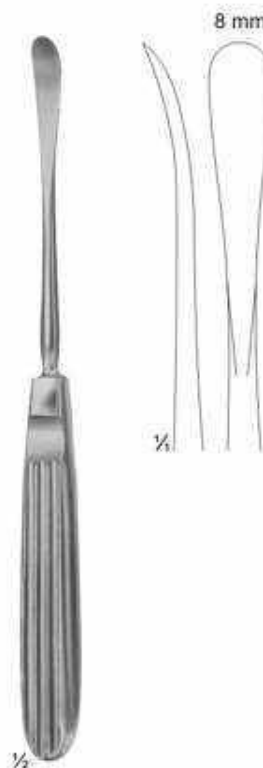

06-8122
COTTLE
195 mm
19.5cm
8 Inch

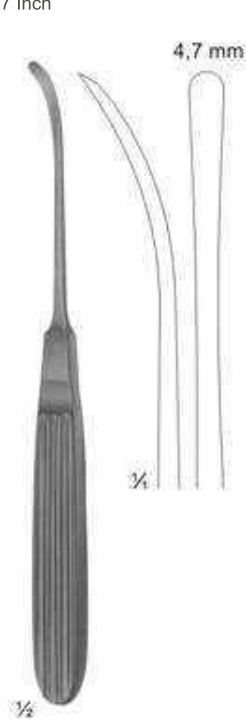

06-8123
LANDOLT
175 mm 17.5cm / 7 Inch



06-8124
CASPAR
180 mm
18cm
7 Inch



06-8125
CASPAR
180 mm
18cm
7 Inch

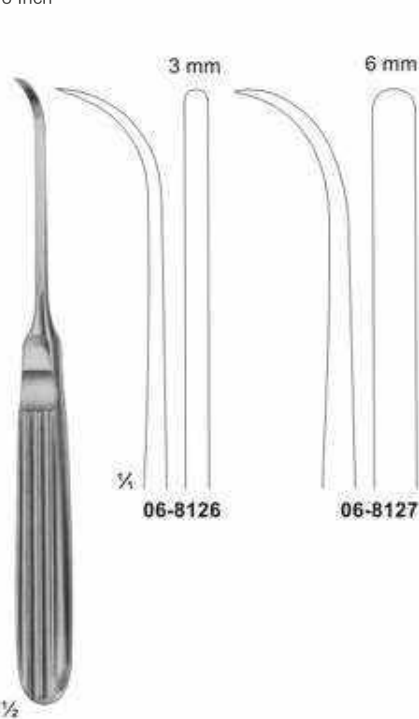

06-8126 - 06-8127
170 mm
17cm
7 Inch

Raspatories



06-8128
FARABEU
 140 mm
 14cm
 6 Inch



06-8129
FARABEU
 140 mm
 14cm
 6 Inch



06-8130
JANSEN
 165 mm / 16.5cm / 6 Inch

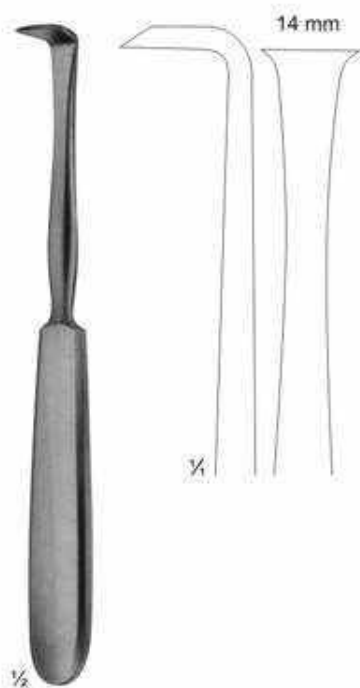

06-8131
LANGENBECK
 180 mm
 18cm
 7 Inch



06-8132
SCHNEIDER
 175 mm
 17.5cm
 7 Inch

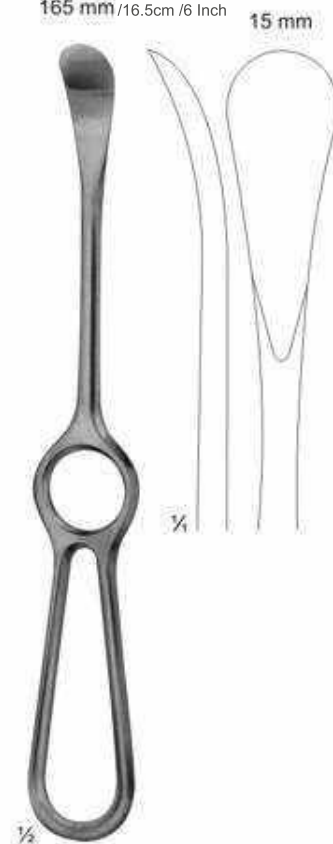

06-8133
SEDILLOT
 215 mm
 21.5cm
 8 Inch

Raspatories



06-8134 - 06-8138
 SEMB
 230 mm / 23cm / 9 Inch



06-8143 06-8144



06-8139 - 06-8140
 DOYEN for children
 06-8141 - 06-8142
 for adults 175 mm

06-8143 - 06-8144
 DOYEN
 240 mm
 24cm
 9 Inch

Raspatories with HARTPRESS-handle

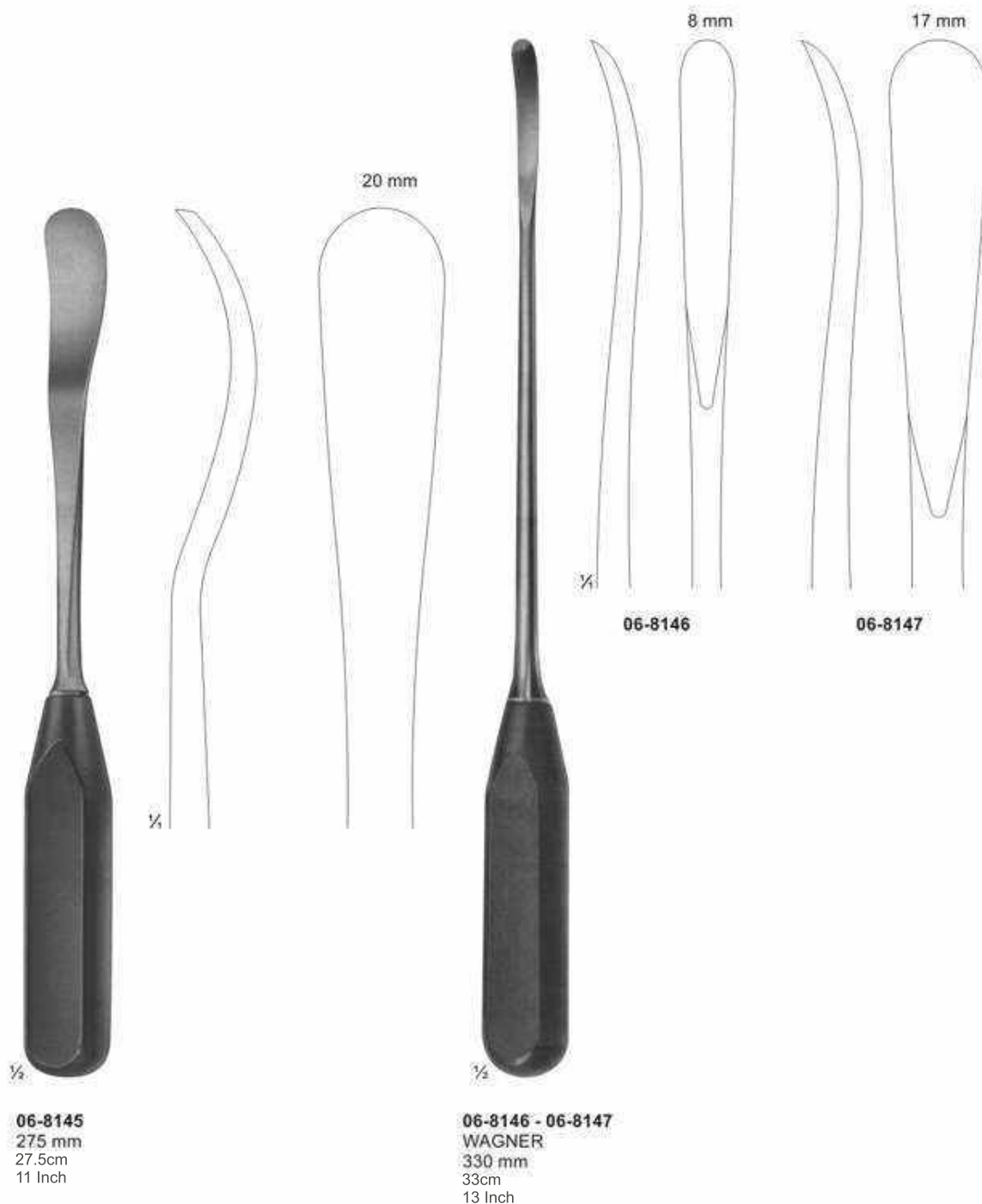

Bone File and Rasps



06-8148
JOSEPH
fine, chequered

06-8149
coarse, chequered
165 mm / 16.5cm / 6 Inch
9 mm



06-8152
MALTZ
down stroke
180 mm
18cm
7 Inch



06-8153
AUFRIEHT
up stroke
06-8154
down stroke
220 mm
22cm
9 Inch

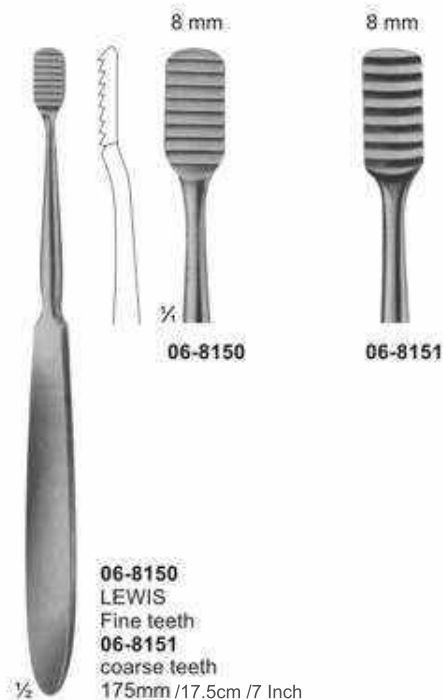
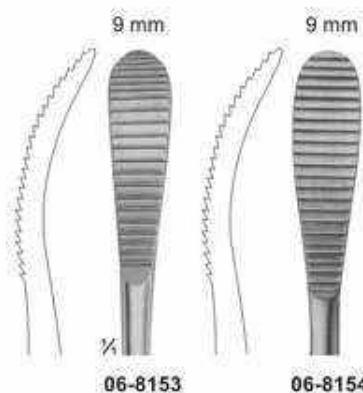

06-8150
LEWIS
Fine teeth
06-8151
coarse teeth
175mm / 17.5cm / 7 Inch



06-8155
GALLAHER
190 mm / 19cm / 7 Inch

Bone File and Rasps, Durogrip Rasps

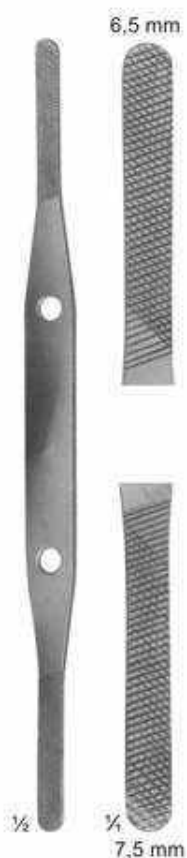

06-8156
FOMON
215mm
21.5cm
8 Inch

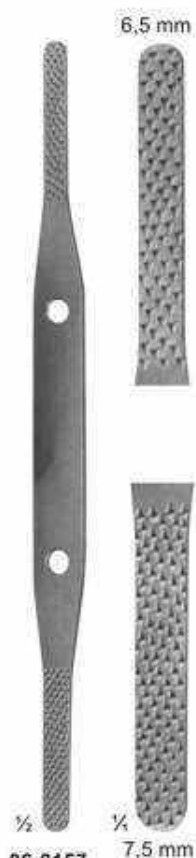

06-8157
FOMON
215mm



06-8158 - 06-8160
MILLER
180 mm
5 mm



06-8159

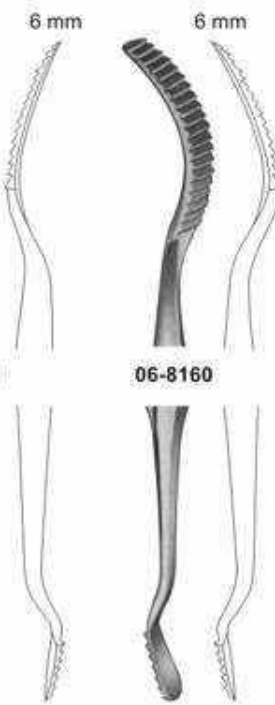

06-8160

4,3 mm

5 mm



06-8161
DUROGRIP
205 mm
20.5cm
8 Inch

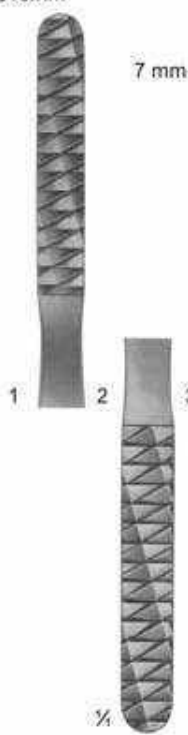

06-8162
Teeth 12/14



06-8163
16/20

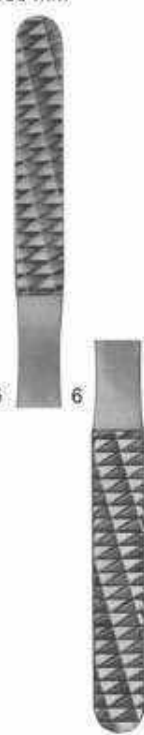

06-8164
24/30

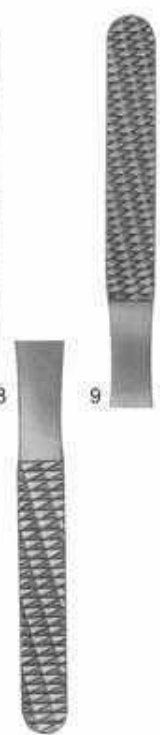

06-8165
36/44



06-8166
52/62

Bone File and Rasps

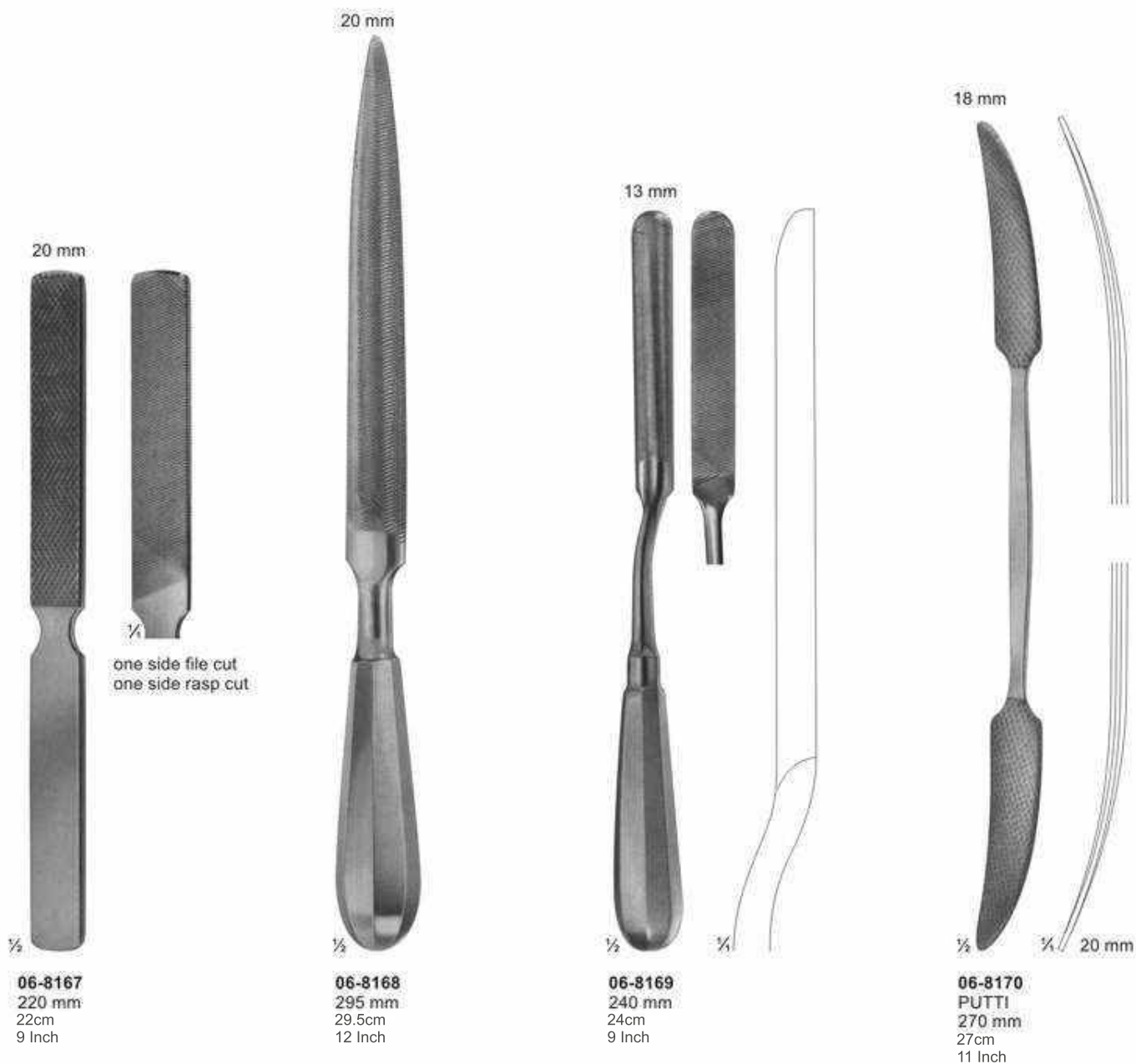



Bone Currettes



06-8171
JACOBSON
140 mm
14cm
6 Inch



06-8172
MARTINI
140 mm
14cm
6 Inch



06-8173
MARTINI
140 mm
14cm
6 Inch



06-8174
WILLIGER
145 mm
14.5cm
6 Inch



06-8175
JANSEN
160 mm
16cm
6 Inch



06-8176
BARTH
180 mm
18cm
7 Inch



06-8177
VOLKMANN
130 mm
13cm
5 Inch



06-8178
VOLKMANN
145 mm
14.5cm
6 Inch



06-8179
VOLKMANN
170 mm
17cm
7 Inch



Bone Currettes



06-8180
JANSEN
160 mm
16cm
6 Inch



06-8181
HEMINGWAY
170 mm
17cm
7 Inch



06-8182
HEMINGWAY
175 mm
17.5cm
7 Inch



06-8183
LUCAS
180 mm
18cm
7 Inch



06-8184
LUCAS
185 mm
18.5cm
7 Inch



06-8185 - 06-8187
KERPEL
145 mm
14.5cm
6 Inch



06-8186 - 06-8188
KERPEL
145 mm
14.5cm
6 Inch

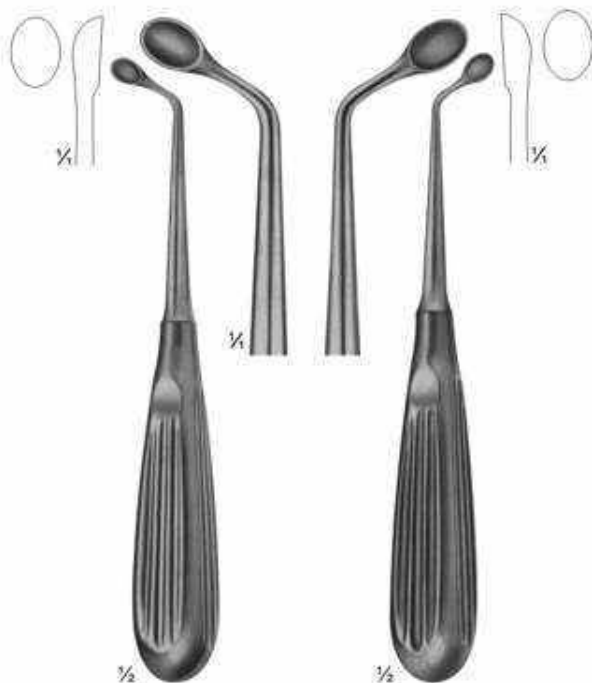

06-8189
UFFENORDE
170 mm
17cm
7 Inch

06-8190
UFFENORDE
170 mm / 17cm / 7 Inch

Bone Currettes

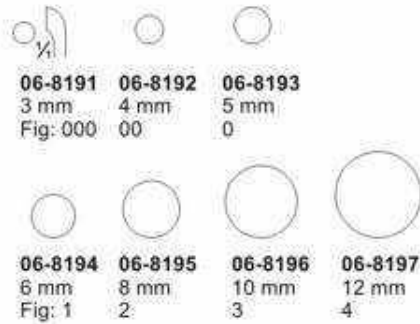

06-8191 - 06-8197
BRUNS
165 mm
16.5cm
7 Inch

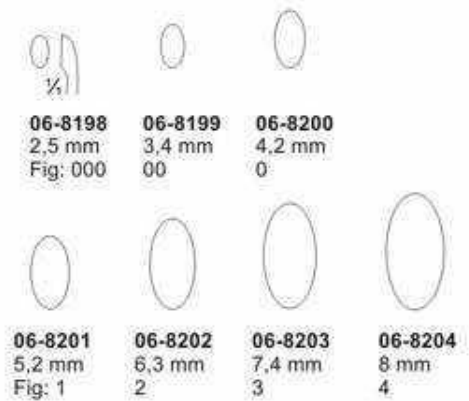

06-8198 - 06-8204
SCHEIDE
170 mm
17cm
7 Inch

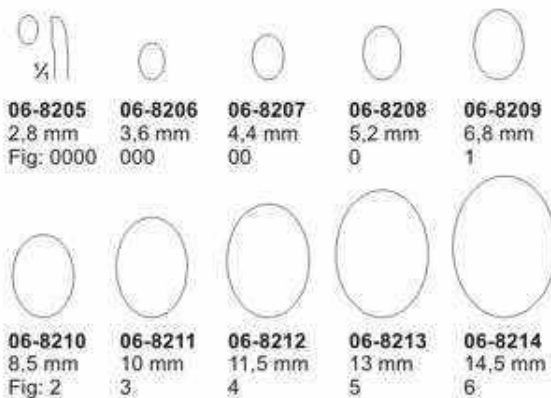

06-8205 - 06-8214
VOLKMANN
170 mm
17cm
7 Inch

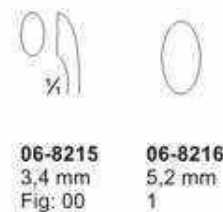

06-8215 - 06-8216
WILLIGER
170 mm
17cm
7 Inch

Bone Currettes



06-8217 - 06-8221
LEMPERT
 215 mm / 21.5cm / 8 Inch



06-8222 - 06-8224
HALLE
 215 mm / 21.5cm / 8 Inch



06-8225 - 06-8228
DAUBENSPECK
 200 mm / 20cm / 8 Inch



06-8229 - 06-8232
 250 mm
 25cm
 10 Inch



06-8233 - 06-8236
 250 mm
 25cm
 10 Inch



06-8237 - 06-8239
BUSHE 250 mm



Bone Currettes



Bone Currettes With Hartpress Handle



06-8259 - 06-8262
270 mm
27cm
11 Inch

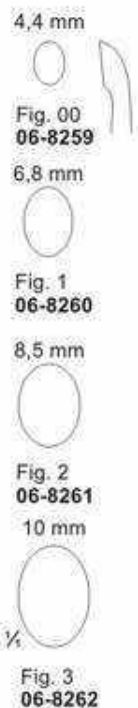

06-8263 - 06-8270
SYPERT
380 mm
38cm
15 Inch

can be sterilized in a steam sterilizer upto 3 bar over pressure (143 C).



Mallets Weight Refer To The Heads Of The Mallets



∅ 20 mm

1/2

06-8271
MEAD
185 g
with interchangeable
plastic disks
190 mm / 19cm / 7 Inch
06-8272
pair of spare disks



∅ 25 mm

1/2

06-8273
140 g
with interchangeable
plastic disks
185 mm / 18.5cm / 7 Inch
06-8274
pair of spare disks



∅ 30 mm

1/2

06-8275
COTTLE
240 g
1 Side flat
1 Side convex
185 mm / 18.5cm / 7 Inch



∅ 22 mm

1/2

06-8276
165 g
lead filled head
190 mm / 19cm / 7 Inch

Mallets, Weights Refer To The Heads Of The



06-8277
HAJEK
 140 g
 220 mm
 22cm
 9 Inch



06-8278
 215 g
 with interchangeable
 plastic disks
 245 mm /24.5cm /10 Inch
06-8279
 pair of spare disks

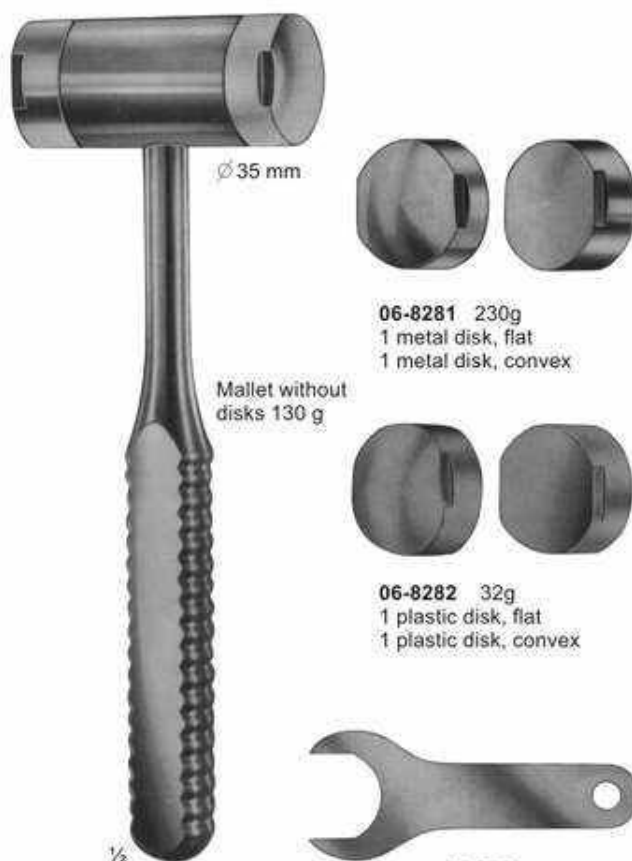

06-8280 - 06-8283
WAGNER
 complete with:
 1 pair of metal disks (**06-8281**) and
 1 pair of plastic disks(**06-8282**) and
 1 wrench (**06-8283**)
 235 mm/23.5cm /9 Inch



06-8281 230g
 1 metal disk, flat
 1 metal disk, convex

Mallet without
 disks 130 g



06-8282 32g
 1 plastic disk, flat
 1 plastic disk, convex



06-8283
 Wrench

Mallets Weight Refer To The Heads Of The Mallets



06-8284 300g
BERGMANN
245 mm
24.5cm
10 Inch



06-8285 300g
BERGMANN
235 mm
23.5cm
9 Inch



06-8286 550g
OMBREDANNE
240 mm
24cm
9 Inch



06-8287
HEATH
copper filled head
700 g
185 mm
18.5cm
7 Inch

Tampers - Osteotomes, Chisels and Gouges



06-8288
HAASE
100 mm /10cm /4 Inch



06-8289 - 06-8290
PASSOW
120 mm /12cm /5 Inch



06-8291 - 06-8293
CASPAR
200 mm /20cm /8 Inch



06-8294 - 06-8296
200 mm /20cm /8 Inch



06-8297 4mm
FREER
Chisel
160 mm
16cm
6 Inch



06-8298 4mm
FREER
Chisel, curved
160 mm
16cm
6 Inch



06-8299 6mm
FREER
Gouge
150 mm
15cm
6 Inch



06-8300 3.4mm
Scaphoid gouge,
downwards curved
135 mm
13.5cm
5 Inch



06-8301 3.4mm
Scaphoid gouge,
upwards curved
135 mm
13.5cm
5 Inch



06-8302 - 06-8304
MANNERFELT modif
Osteotomes:
06-8302 4 mm
06-8303 6 mm
06-8304 8 mm
155 mm /15.5cm /6 Inch

Osteotomes Chisels and Gouges



06-8305 3mm
MANNERFELT modif.
 Gouge
 155 mm
 15.5cm
 6 Inch

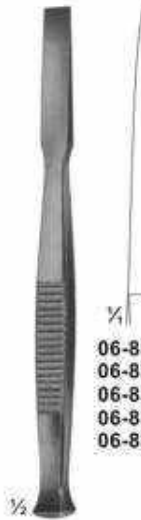

06-8306 - 06-8310
 Osteotomes
 140 mm
 14cm
 6 Inch

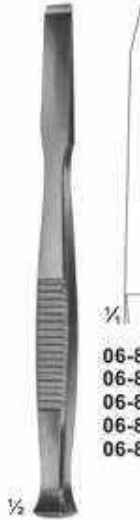

06-8311 - 06-8315
 Chisels
 140 mm
 14cm
 6 Inch



06-8316 - 06-8320
 Gouges
 140 mm
 14cm
 6 Inch



PARTSCH
06-8321 - 06-8324
 Chisels
 140 mm
 14cm
 6 Inch

06-8306 4 mm
06-8307 6 mm
06-8308 8 mm
06-8309 10 mm
06-8310 12 mm

06-8311 4 mm
06-8312 6 mm
06-8313 8 mm
06-8314 10 mm
06-8315 12 mm

06-8316 4 mm
06-8317 6 mm
06-8318 8 mm
06-8319 10 mm
06-8320 12 mm

06-8321 3 mm
06-8322 4 mm
06-8323 5 mm
06-8324 6 mm



PARTSCH
06-8325 - 06-8329
 Chisels
 170 mm
 17cm
 7 Inch

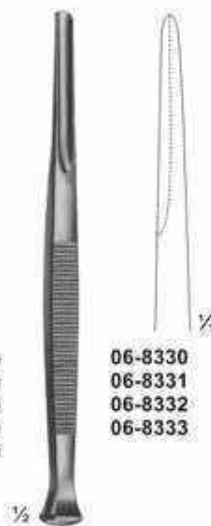

PARTSCH
06-8330 - 06-8333
 Gouges
 140 mm
 14cm
 6 Inch



PARTSCH
06-8334 - 06-8338
 Gouges
 170 mm
 17cm
 7 Inch



LUCAS
06-8339 - 06-8340
 Chisels
 160 mm
 16cm
 6 Inch



LUCAS
06-8341 - 06-8342
 Gouges
 160 mm

06-8325 3 mm
06-8326 4 mm
06-8327 5 mm
06-8328 6 mm
06-8329 7 mm

06-8330 3 mm
06-8331 4 mm
06-8332 5 mm
06-8333 6 mm

06-8334 3 mm
06-8335 4 mm
06-8336 5 mm
06-8337 6 mm
06-8338 7 mm

06-8339 4 mm
06-8340 6 mm

06-8341 3 mm
06-8342 5 mm

Osteotomes Chisels and Gouges



06-8343 5 mm
06-8344 7 mm
06-8345 9 mm
06-8346 11 mm

ALEXANDER
06-8343 - 06-8346
Gouges
170 mm / 17cm / 7 Inch

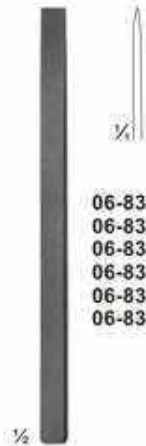

06-8347 4 mm
06-8348 6 mm
06-8349 8 mm
06-8350 10 mm
06-8351 12 mm
06-8352 15 mm

LAMBOTTE
06-8347 - 06-8352
Osteotomes
125 mm / 12.5cm / 5 Inch

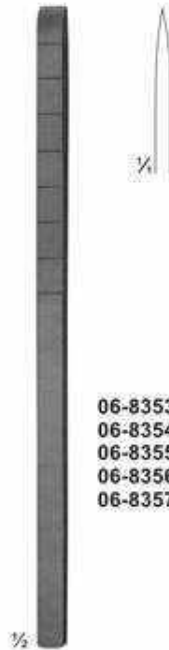

06-8353 4 mm
06-8354 6 mm
06-8355 8 mm
06-8356 10 mm
06-8357 12 mm

COTTLE
06-8353 - 06-8357
Osteotomes with depth
markings
180 mm / 18cm / 7 Inch



06-8358 4 mm
06-8359 7 mm
06-8360 9 mm
06-8361 12 mm

COTTLE
06-8358 - 06-8361
Chisel-Osteotomes
with depth markings
180 mm / 18cm / 7 Inch



COTTLE
06-8362 8mm
Fishtail Chisel,
with protected ends
180 mm / 18cm / 7 Inch



06-8363 10 mm
06-8364 12 mm
06-8365 15 mm
06-8366 20 mm
06-8367 25 mm

STILLE
06-8363 - 06-8367
Chisels
205 mm
20.5cm
8 Inch

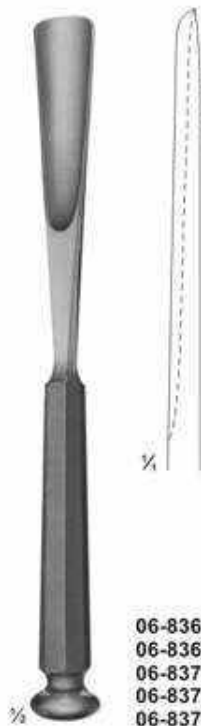

06-8368 10 mm
06-8369 12 mm
06-8370 15 mm
06-8371 20 mm
06-8372 25 mm

STILLE
06-8368 - 06-8372
Gouges
205 mm
20.5cm
8 Inch



06-8373 10 mm
06-8374 15 mm

WALTER
06-8373 - 06-8374
gouges for taking
grafts from the ribs
205 mm
20.5cm
8 Inch



06-8375 8mm
06-8376 10 mm
06-8377 12 mm
06-8378 15 mm
06-8379 20 mm
06-8380 25 mm

STILLE
06-8375 - 06-8380
Osteotomes
205 mm
20.5cm
8 Inch

Osteotomes















STILLE
06-8381 - 06-8385
 Osteotomes
 205 mm
 20.5cm
 8 Inch

STILLE
06-8386 - 06-8390
 Osteotomes, curved
 205 mm
 20.5cm
 8 Inch

LAMBOTTE
06-8391 - 06-8402
 Osteotomes
 245 mm
 24.5cm
 10 Inch

LAMBOTTE
06-8403 - 06-8408
 Osteotomes, curved
 245 mm
 24.5cm
 10 Inch

Osteotomes, Chisels and Gouges with HARTPRESS -handle

 <p>1/2</p>	 <p>1/4</p> <p>06-8409 4 mm 06-8410 6 mm 06-8411 8 mm 06-8412 10 mm 06-8413 12 mm</p>	 <p>1/2</p>	 <p>1/4</p> <p>06-8414 4 mm 06-8415 6 mm 06-8416 8 mm 06-8417 10 mm 06-8418 12 mm</p>	 <p>1/2</p>	 <p>1/4</p> <p>06-8419 5 mm 06-8420 7 mm 06-8421 10 mm 06-8422 15 mm 06-8423 20 mm 06-8424 25 mm 06-8425 30 mm</p>			
<p>LEXER-MINI 06-8409 - 06-8413 Osteotomes 180 mm 18cm 7 Inch</p>	<p>LEXER-MINI 06-8414 - 06-8418 Gouges 180 mm/18cm /7 Inch</p>	<p>LEXER 06-8419 - 06-8425 Gouges 220 mm /22cm /9 Inch</p>	 <p>1/2</p>	 <p>1/4</p> <p>06-8426 5 mm 06-8427 7 mm 06-8428 10 mm 06-8429 15 mm 06-8430 20 mm 06-8431 25 mm 06-8432 30 mm</p>	 <p>1/2</p>	 <p>1/4</p>	 <p>1/2</p>	 <p>1/4</p> <p>06-8434 5,5 mm 06-8435 9,0 mm</p>
<p>LEXER 06-8426 - 06-8432 Osteotomes. 220 mm 22cm 9 Inch</p>	<p>06-8433 9mm Gouge for removing broken screws 220 mm 22cm 9 Inch</p>	<p>ZIELKE 06-8434 - 06-8435 Gouges for scoliosis-operations. 230 mm 23cm 9 Inch</p>						

Osteotomes, Chisels and Gouges with HARTPRESS -handle



06-8436 10 mm
06-8437 15 mm

06-8438 10 mm
06-8439 15 mm

06-8440 20mm
Chisel
245 mm
24.5cm
10 Inch

06-8441 16mm
Chisel, curved
265 mm
26.5cm
10 Inch

LEXER
06-8436 - 06-8437
Osteotomes,
angled
275 mm
27.5cm
11 Inch

LEXER
06-8438 - 06-8439
Gouges,
angled
275 mm
27.5cm
11 Inch

Reposition Forceps

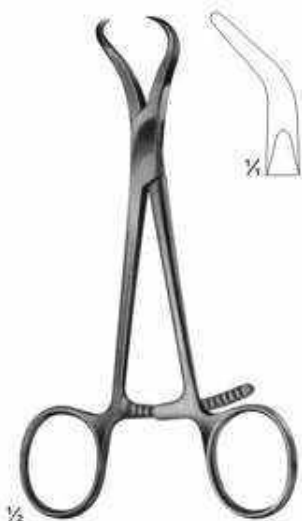

06-8442
 Reposition forceps,
 for small fragments.
 135 mm / 13.5cm / 5 Inch



06-8443
HAASE
 Reposition forceps,
 for mandibular
 fractures.
 165 mm / 16.5cm / 6 Inch



06-8444
REILL
 Reposition forceps,
 170 mm / 17cm / 7 Inch



06-8445
 Reposition forceps
 205 mm
 20.5cm
 8 Inch



06-8446
MEYER
 Reposition forceps
 for fingers, with drill
 guide for KIRSCHNER
 wires up to diam. 1.0 mm
 170 mm / 17cm / 7 Inch

Reposition Forceps, Bone Holding Forceps



06-8447
Patella forceps
185 mm /23.5cm /9 Inch



06-8448
Forceps with
ratchet fixation
140 mm /14cm /6 Inch



06-8449
Forceps with
thread fixation
170 mm
17cm
7 Inch



06-8450
Forceps with
thread fixation
235 mm
23.5cm
9 Inch

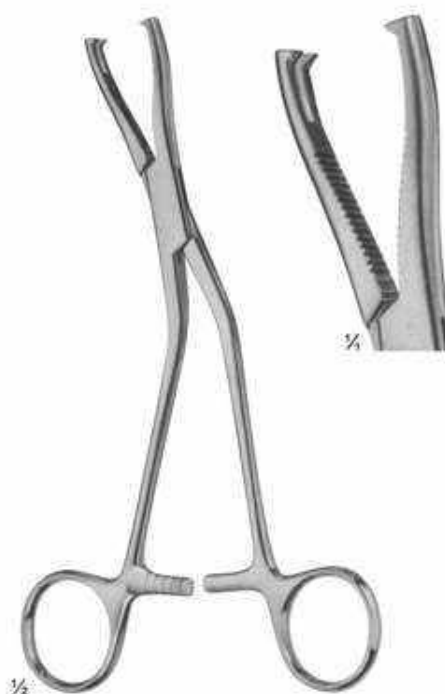

06-8451
DINGMANN modif
185 mm /23.5cm /9 Inch

Bone Holding Forceps



06-8452
 Sequestrum
 forceps
 200 mm
 20cm
 8 Inch



06-8453
 VAN BUREN
 Sequestrum
 forceps
 225 mm
 22.5cm
 9 Inch



06-8454
 LANGENBECK
 205 mm
 20.5cm
 8 Inch



06-8455
 FERGUSON
 205 mm
 20.5cm
 8 Inch

Bone Holding Forceps

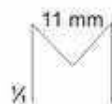
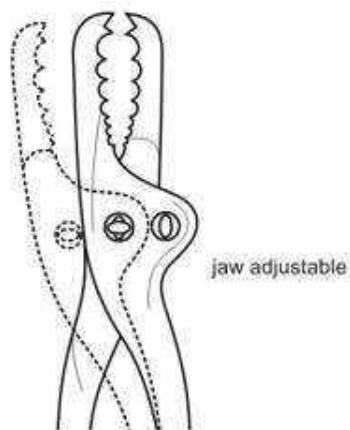

06-8456
SEMB
 190 mm
 19cm
 7 Inch



06-8457
FARABEU
 230 mm
 23cm
 9 Inch



06-8458
FARABEU
 255 mm
 25.5cm
 10 Inch



06-8459
FARABEU-LAMBOTTE
 255 mm / 25.5cm / 10 Inch

Bone Holding Forceps

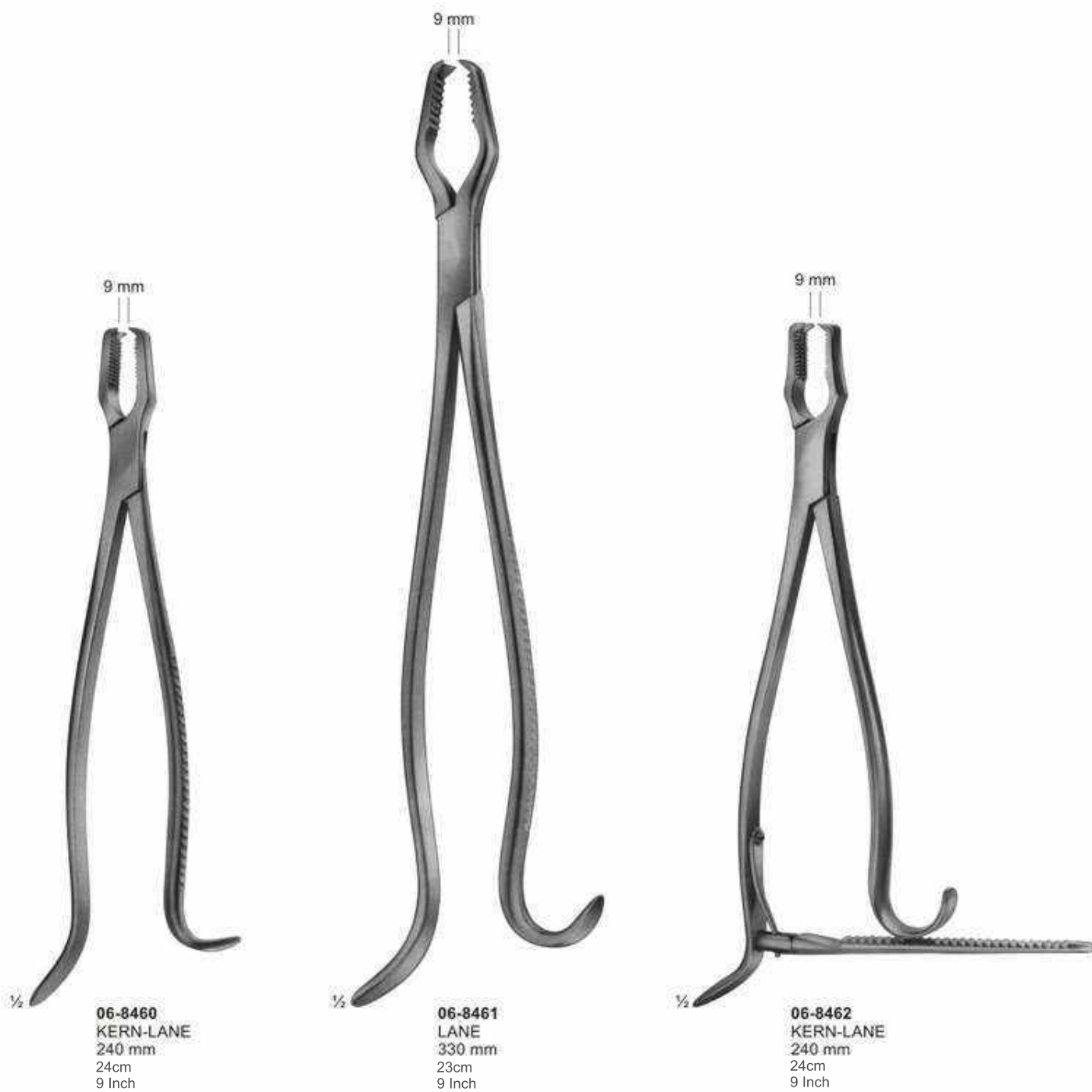

Bone Holding Forceps



06-8463
LANE
 320 mm
 32cm
 12 Inch



06-8464
HEY GROVES
 305 mm
 30.5cm
 12 Inch

Bone Holding Forceps

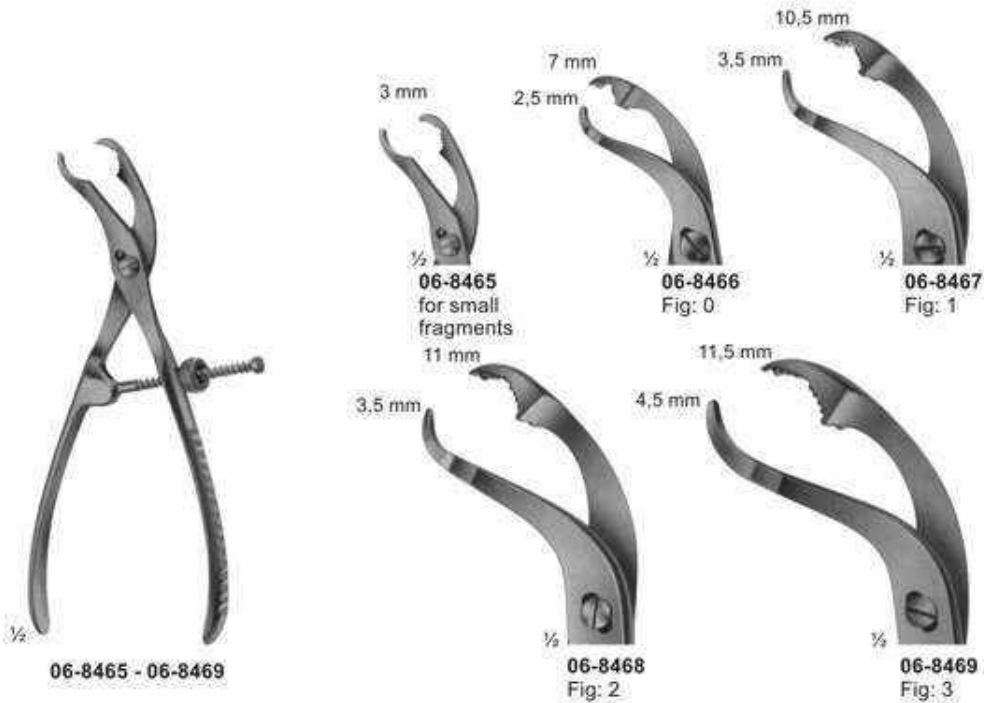

06-8465 - 06-8469

06-8465 145 mm
06-8466 190 mm
06-8467 240 mm
06-8468 260 mm
06-8469 280 mm

Self-centering forceps
with thread fixation

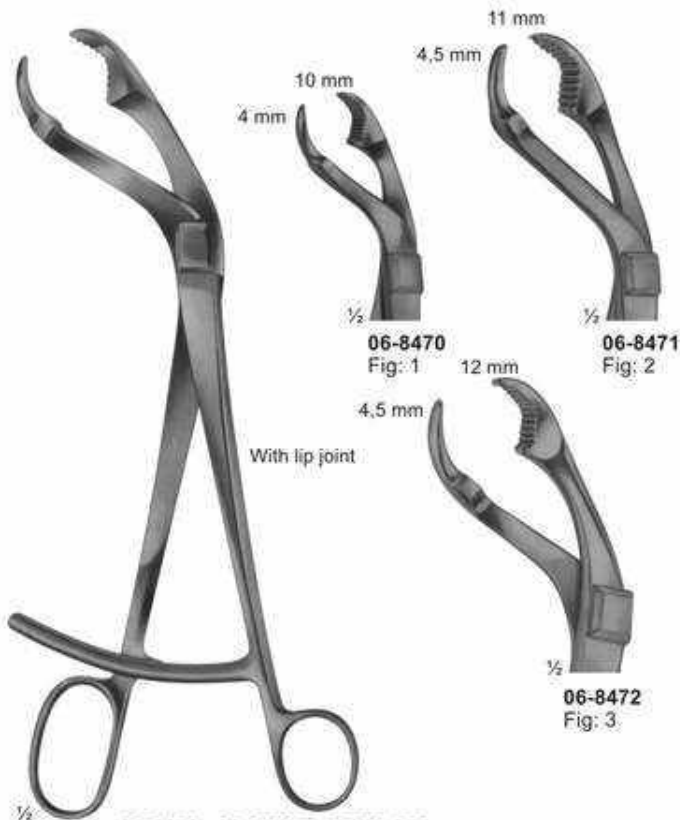

06-8470 - 06-8472 VERBRUGGE
06-8470 255 mm /25.5cm /10 Inch
06-8471 265 mm /26.5cm /10 Inch
06-8472 270 mm /27cm /11 Inch



06-8473
LAMBOTTE
265 mm /26.5cm /10 Inch

Bone Clamps



06-8474 - 06-8475
LOWMAN
 06-8474 170 mm /17cm /7 Inch
 06-8475 205 mm /20.5cm /8 Inch



06-8476
LOWMAN-GERSTER
 210 mm /21cm /8 Inch



06-8477
LOWMAN-HOGLUND
 175 mm /17.5cm /7 Inch

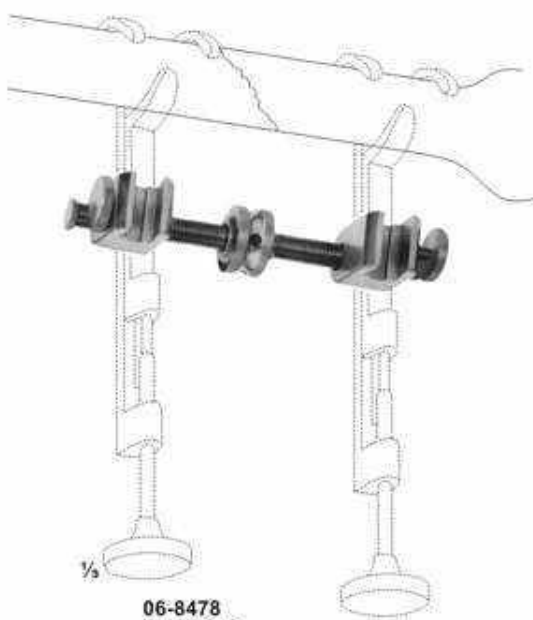

06-8478
GERSTER
 Traction bar for 06-8474 - 06-8477

Synovectomy-Rongeurs, Bone Rongeurs



06-8479 - 06-8480
 Synovectomy rongeur
 width of jaws 1.2 mm
 130 mm /13cm /5 Inch



06-8481 - 06-8482
 Synovectomy rongeur
 width of jaws 2.0 mm
 130 mm /13cm /5 Inch



06-8483
STELLBRINK
 Synovectomy rongeur
 175 mm /17.5cm /7 Inch



06-8484
STELLBRINK
 Synovectomy rongeur
 170 mm /17cm /7 Inch



06-8485
LUER-FRIEDMANN
 145 mm /14.5cm /6 Inch



06-8486
 140 mm
 14.5cm
 6 Inch

Bone Rongeurs



06-8487
LUER
 150 mm
 15cm
 6 Inch



06-8488
LUER
 155 mm
 15.5cm
 6 Inch



06-8489
BLUMENTHAL
 155 mm
 15.5cm
 6 Inch



06-8490
BLUMENTHAL
 150 mm
 15cm
 6 Inch



06-8491 - 06-8492
JANSEN
 175 mm
 17.5cm
 7 Inch

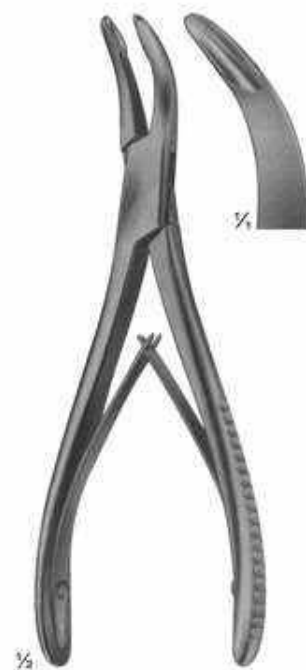

06-8493
BANE-HARTMANN
 175 mm
 17.5cm
 7 Inch

Bone Rongeurs



06-8494
ALEXANDER
 140 mm /14cm /6 Inch



06-8495
JANSEN
 190 mm /19cm /6 Inch

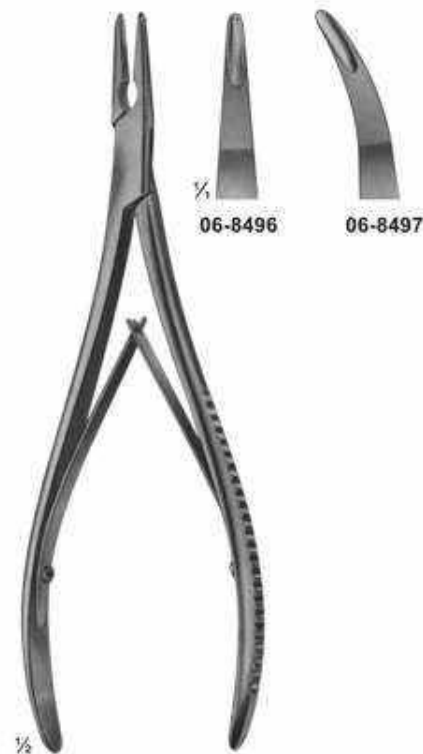

06-8496 - 06-8497
LEMPERT
 200 mm /20cm /8 Inch



06-8498
BEYER
 180 mm
 18cm
 7 Inch



06-8499
MEAD
 165 mm
 16.5cm
 6 Inch



06-8500
MEAD
 165 mm
 16.5cm
 6 Inch

Bone Rongeurs

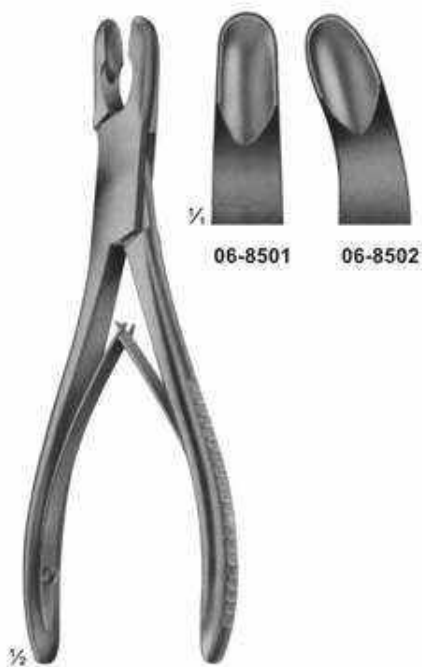

06-8501 06-8502

06-8501 - 06-8502
 LUER
 175 mm
 17.5cm
 7 Inch



06-8503
 LUER
 180 mm
 18cm
 7 Inch



06-8504
 LUER
 180 mm
 18cm
 7 Inch



06-8505
 OLIVECRONA
 205 mm
 20.5cm
 8 Inch



06-8506 - 06-8507
 BOHLER
 155 mm
 15.5cm
 6 Inch



06-8508
 MARQUARDT
 200 mm/20cm /8 Inch

Bone Rongeurs



06-8509
RUSKIN
 190 mm
 19cm
 7 Inch



06-8510
ROETTGEN-RUSKIN
 240 mm
 24cm
 9 Inch



06-8511 - 06-8512
ECHLIN
 230 mm
 23cm
 9 Inch

Bone Rongeurs



06-8513
STILLE
 235 mm
 23.5cm
 9 Inch



06-8514
LEKSELL-STILLE
 240mm
 24cm
 9 Inch



06-8515
STILLE-RUSKIN
 240mm
 24cm
 9 Inch

Bone Rongeurs



06-8516
LUER-STILLE
225 mm
22.5cm
9 Inch



06-8517
LUER-STILLE
225 mm
22.5cm
9 Inch

Bone Rongeurs



06-8518
LUER-STILLE
 270 mm
 27cm
 11 Inch



06-8519
SEMB
 240 mm
 24cm
 9 Inch

Bone Cutting Forceps



06-8520
STAMM
150 mm
15cm
6 Inch



06-8521
KAZANJIAN
185 mm
18.5cm
7 Inch



06-8522 - 06-8525
LISTON



06-8522
140 mm



06-8523
170 mm



06-8524
200 mm



06-8525
220 mm



06-8526 - 06-8528
LISTON



06-8526
170 mm



06-8527
200 mm



06-8528
220 mm

Bone Cutting Forceps



06-8529
BOEHLER
 145 mm
 14.5cm
 6 Inch



06-8530
RUSKIN-LISTON
 190 mm
 19cm
 7 Inch



06-8531
RUSKIN-LISTON
 190 mm
 19cm
 7 Inch

Bone Cutting Forceps



06-8532
 LISTON
 curved on flat
 240 mm
 24cm
 9 Inch

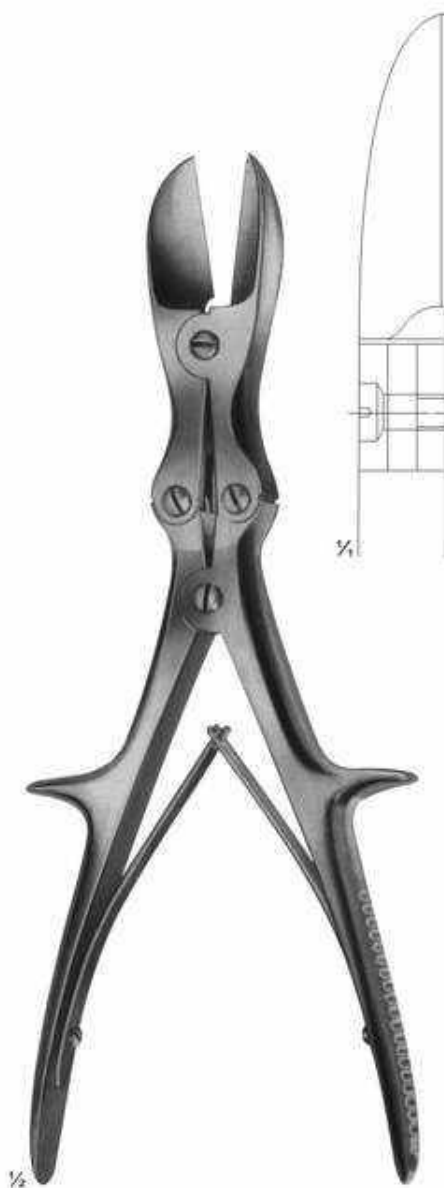

06-8533
 LISTON
 straight
 280 mm
 28cm
 11 Inch



06-8534
 LISTON
 curved on flat
 280 mm
 28cm
 11 Inch

Bone Cutting Forceps

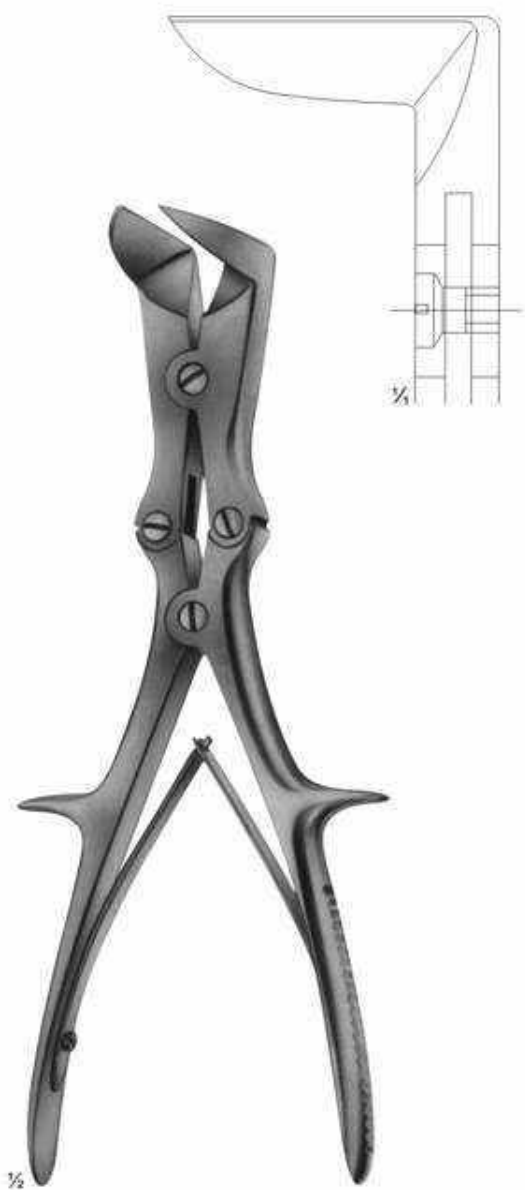

06-8535
LISTON-STILLE
 265 mm
 26.5cm
 10 Inch

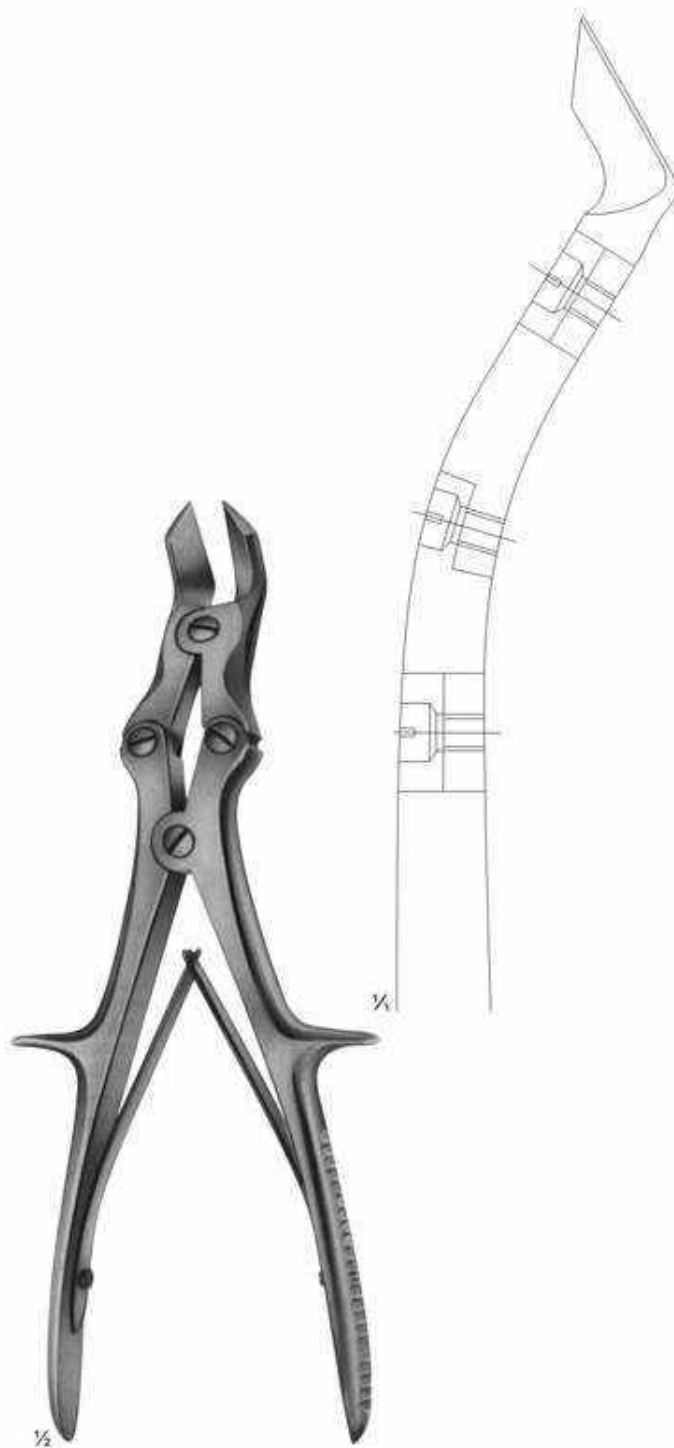

06-8536
LISTON-KEY-HORSLEY
(TUDOR EDWARDS)
 255 mm
 25.5cm
 10 Inch

Meniscus-and Cartilage Forceps



06-8537
 BIRCHER
 200 mm
 20cm / 8 Inch



06-8538
 BIRCHER
 200 mm
 20cm / 8 Inch



06-8539
 WELER
 200 mm
 20cm / 8 Inch

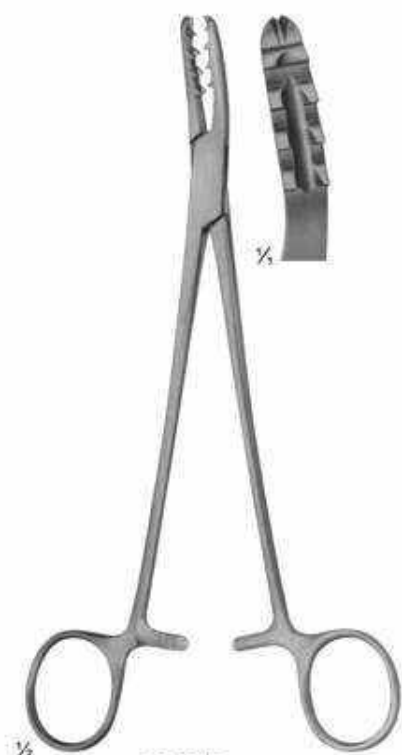

06-8540
 BIRCHER-GANSKE
 200 mm / 20cm / 8 Inch



06-8541
 BIRCHER-GANSKE
 200 mm / 20cm / 8 Inch



06-8542
 MARTIN
 205 mm
 20.5cm / 8 Inch

Meniscus Knives



06-8543
 170 mm
 7cm
 7 Inch



06-8544
 NEFF
 215 mm
 21.5cm
 8 Inch



06-8545
 NEFF
 215 mm
 21.5cm
 8 Inch



06-8546
 WAGNER
 215 mm
 21.5cm
 8 Inch

Meniscus Knives

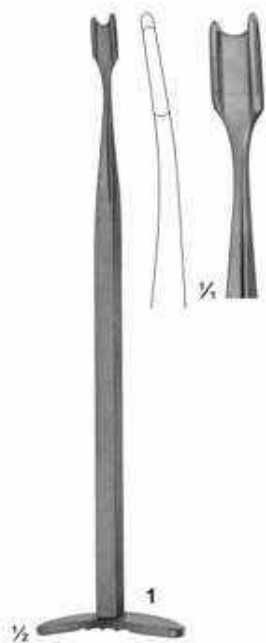

06-8547
SMILLIE
170 mm / 17cm / 7 Inch

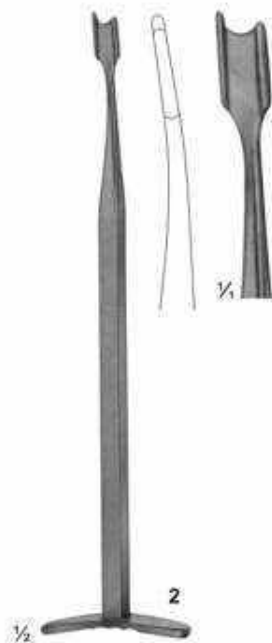

06-8548
SMILLIE
170 mm / 17cm / 7 Inch

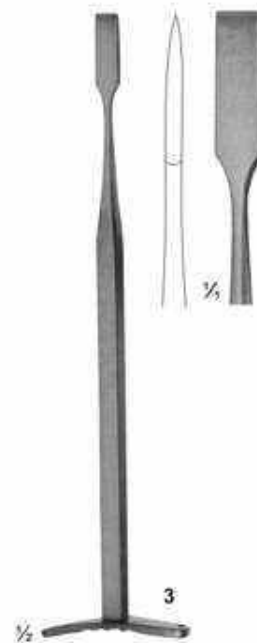

06-8549
SMILLIE
170 mm / 17cm / 7 Inch



06-8550
SALENIUS
220 mm
22cm
9 Inch



06-8551
SALENIUS
220 mm
22cm
9 Inch



06-8552
CANAD. MODELL
200 mm
20cm
8 Inch



06-8553
CANAD. MODELL
200 mm / 20cm / 8 Inch

Wire Extension

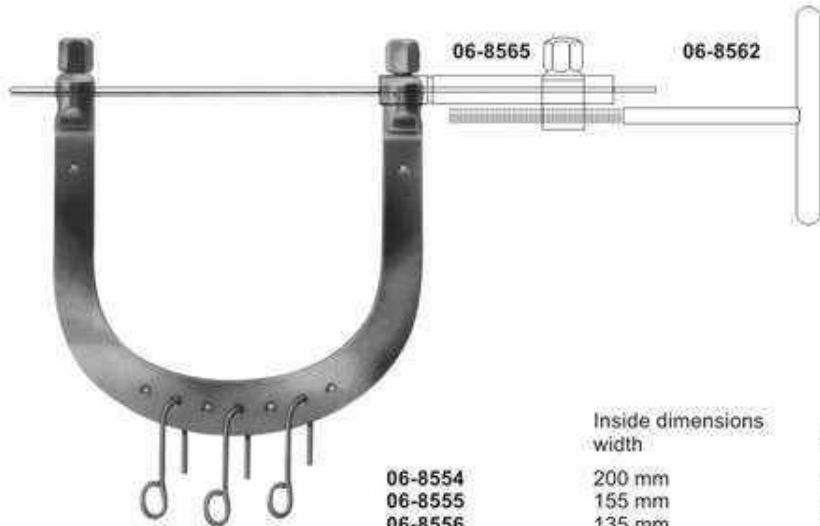

06-8554 - 06-8560
KIRSCHNER
Wire traction bows,
to be used with
KIRSCHNER-wires
up to 2.5 mm diam.,
With 3 hooks,
stainless steel

	Inside dimensions width	depth	
06-8554	200 mm	155 mm	for the hip
06-8555	155 mm	155 mm	for the femur
06-8556	135 mm	130 mm	for the knee
06-8557	120 mm	120 mm	for the knee
06-8558	105 mm	100 mm	for the knee
06-8559	95 mm	110 mm	for the calcaneus
06-8560	95 mm	70 mm	for the arm and elbow



06-8561
Wrench, double - ended,
for wire traction bows



06-8562
Wire tightener, with
clamping jaws



06-8563
Traction hook only,
large size



06-8564
Traction hook only,
small size



06-8565
Fixation clamp, to secure clamping
jaws of **06-8562** stainless steel

Wire Extension

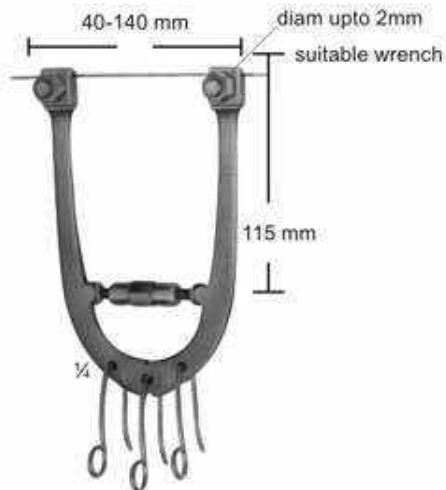

06-8566
Wire traction bow, adjustable,
with 3 hooks, small size.

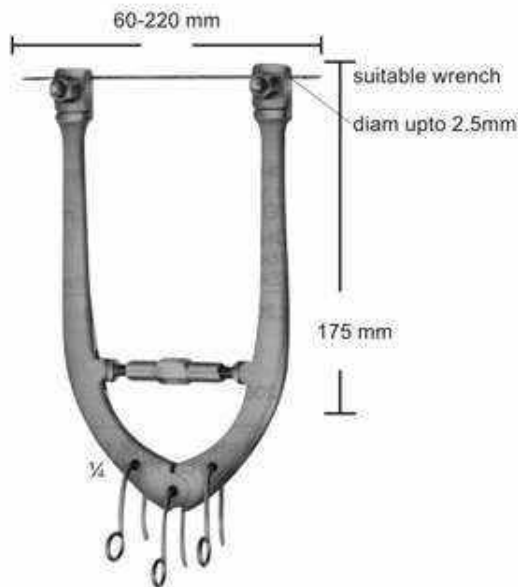

06-8567
Wire traction bow, adjustable,
with 3 hooks, large size

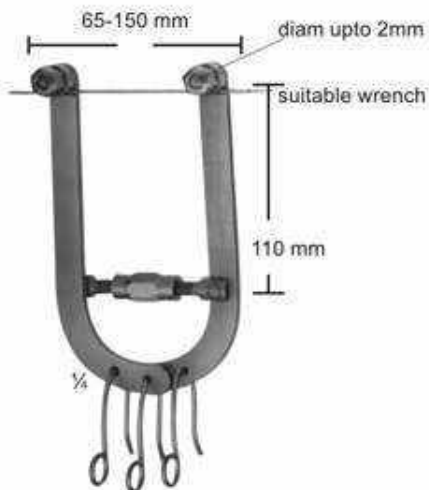

06-8568
Wire traction bow, adjustable,
with 3 hooks, small size for
elbow and calcaneus, for
adolescents



06-8569 max. 105 mm
06-8570 max. 160 mm
06-8571 max. 200 mm

06-8569 80-95 mm
06-8570 90-120 mm
06-8571 140-170 mm

diam upto
06-8569 1,6 mm
06-8570 2,0 mm
06-8571 2,5 mm

06-8569 - 06-8571
KIRSCHNER
Wire traction bows, modified,
adjustable in width, holds wire
securely, with 1 hook



06-8572
Fixation disc, slotted



06-8573
Idem, aluminum, transparent
to X-rays



06-8574
Fixation disc, slotted



06-8575
Screw driver, for above
fixations discs

Traction Bows, Distractor



Boehler traction bows, to be used with STEINMANN pins, 4mm diam

Boehler traction bows, to be used with STEINMANN pins, 5mm diam

		Inside width	For
06-8576 with pin (09-8588)		16x9cm	Arm
06-8577 without pin	06-8582 without pin		
06-8578 with pin (09-8590)		21x11cm	Femur and knee
06-8579 without pin	06-8583 without pin		
06-8580 with pin (09-8592)		21x15cm	Femur and knee
06-8581 without pin			



06-8584 - 06-8598

STEINMANN

triangular shaft ended and trocar point

diam ϕ	4,0 mm	5,0 mm
Length		
80 mm	06-8584	
100 mm	06-8585	
120 mm	06-8586	
140 mm	06-8587	
150 mm	06-8588	06-8594
160 mm	06-8589	
180 mm	06-8590	06-8595
200 mm	06-8591	06-8596
210 mm	06-8592	
250 mm	06-8593	06-8597
300 mm		06-8598



06-8599

SCHWARZ

Traction bow for fingers, to be used with KIRSCHNER-wire up to 1.6 mm diam.

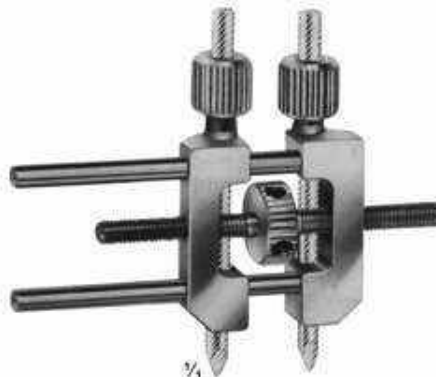

06-8600

Small distractor

as a repositioning device for distraction and compression of small bones; for wires with 3.0 mm diam.



06-8601

Protection cap for 4,0 mm STEINMANN Pins



06-8602

Protection cap for 5,0 mm STEINMANN Pins

Drilling Chucks and Cerclage Wire Tightener.



1/2

06-8603
REILL
Drilling chuck, cannulated, for shanks from 2.0 - 2.5 mm diam.
115 mm
11.5cm
6 Inch



1/2

06-8604
Drilling chuck, cannulated, for shanks from 0.8 - 2.0 mm diam
150 mm
15cm
6 Inch



1/2

06-8605
Drilling chuck, cannulated, for shanks up to 4.5 mm diam with key
140 mm
14cm
6 Inch



1/2

Movable tip made of (material used for implants). While twisting the movable head remains stable, therefore the wire will not slip off.

06-8606
LOUTE
Wire tightener, improved pattern, with movable tip, for wires up to 1.0 mm diam.
220 mm
22cm
9 Inch

Chuck jaws made of material used for implants



1/2

06-8607
Drilling chuck, cannulated, for shanks up to 6.35 mm diam., To be tightened by hand
100 mm /10cm /4 Inch



1/2

06-8608
Drilling chuck, cannulated, for shanks up to 4.5 mm diam., And for triangular shaft width across flats 4.7 mm (schanz screws, steinmann pins). with key **06-8609**



06-8611



1/2

06-8610
Drilling chuck, cannulated, for shanks up to 6.35 mm diam., With key **06-8611**
160 mm /16cm /9 Inch

Cerclage Instruments

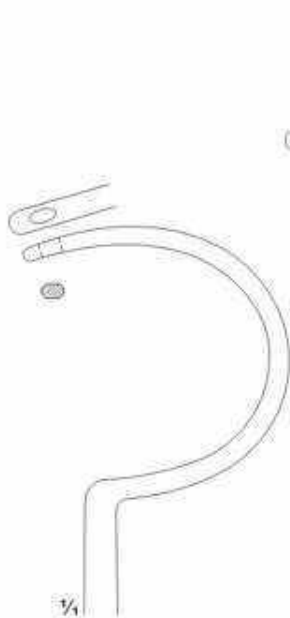

06-8612
 275 mm
 27.5cm
 11 Inch

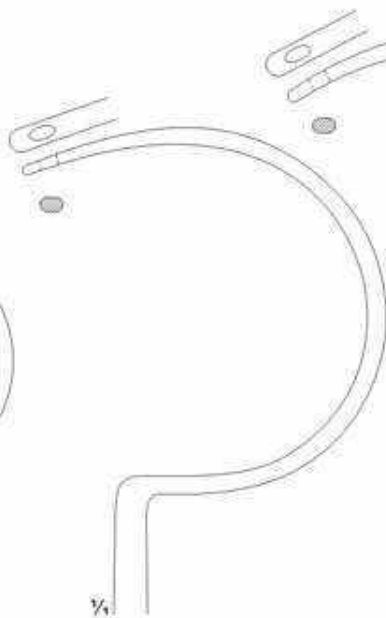

06-8613
 285 mm
 28.5cm
 11 Inch

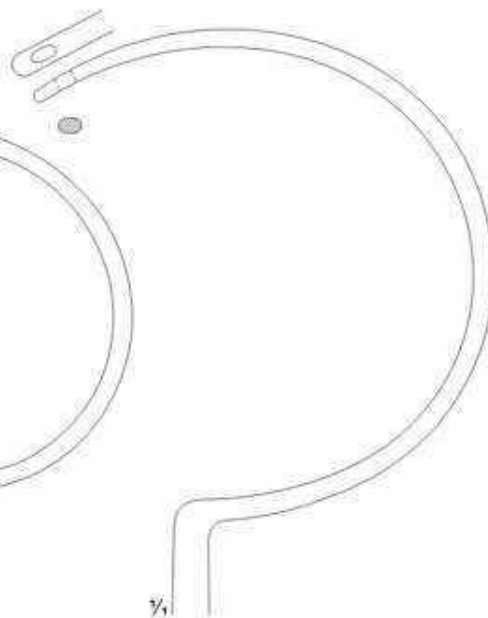

06-8614
 305 mm
 30.5cm
 12 Inch



06-8612 - 06-8614
 DEMEL
 Wire guides

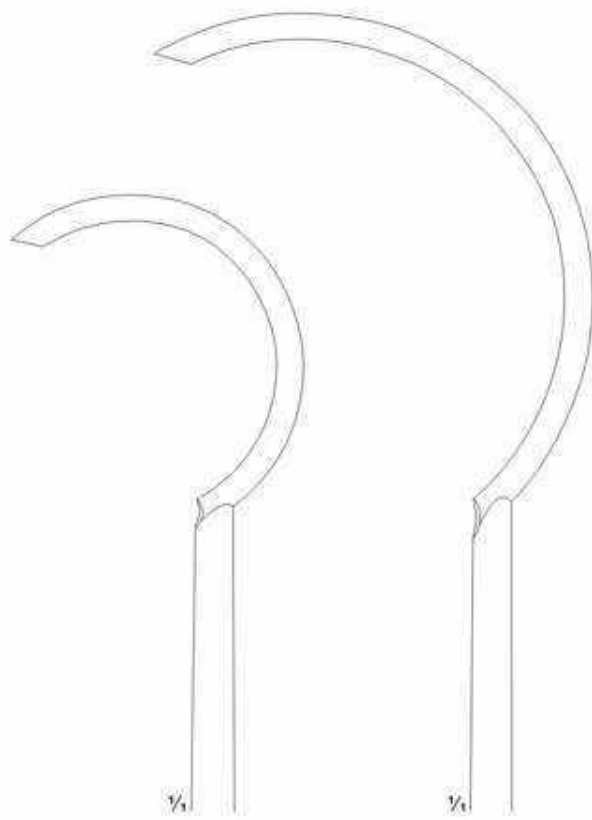

06-8615
 240 mm
 24cm
 9 Inch

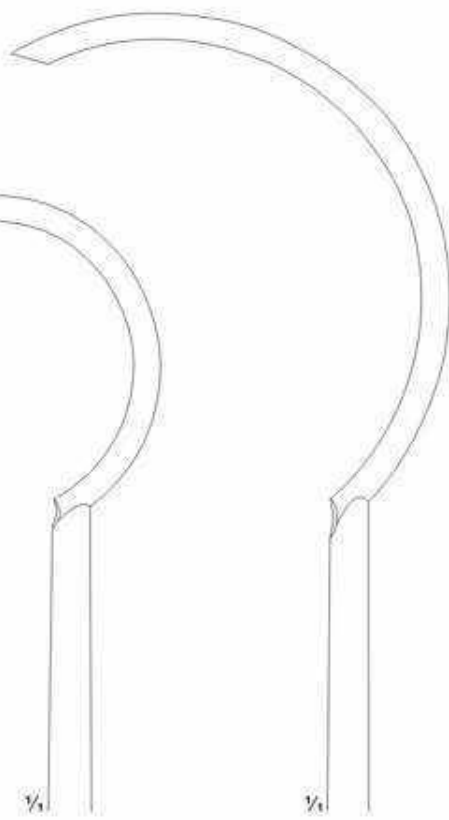

06-8616
 270 mm
 27cm
 11 Inch



06-8617
 225 mm
 22.5cm
 9 Inch

JORDAN instruments for subcutaneous Tibia Cerclage

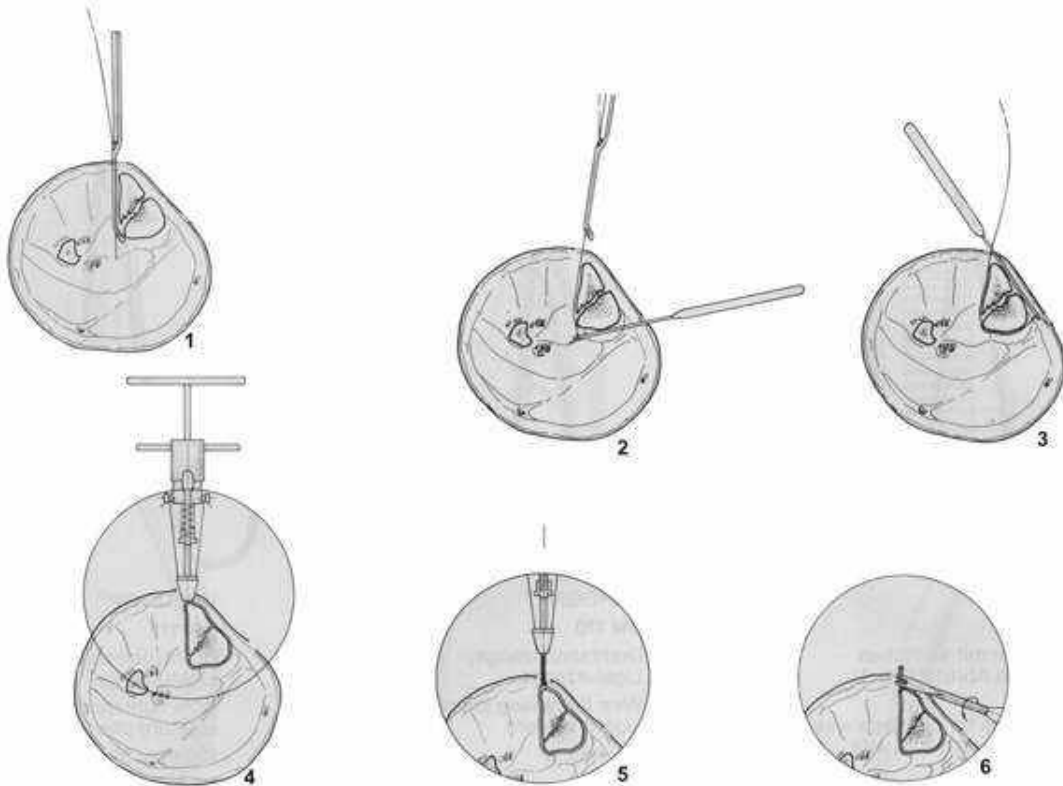

06-8618
JORDAN
Wire tightener



06-8619
JORDAN
Wire twister
170 mm
17cm
7 Inch



06-8620
JORDAN
Wire catcher
180 mm
18cm
7 Inch



06-8621
JORDAN
Probe, cannulated
170 mm
17cm
7 Inch

Wire Holding forceps, Wire Tightening Pliers, Flat-nosed Pliers DUROGRIP with Hard Metal Inserts



06-8622
DUROGRIP
Holding forceps for cerclage
wire, with lateral jaws to avoid
wire slipping off
170 mm / 17cm / 7 Inch



06-8623
DUROGRIP
Wire, tightening pliers,
Ligature pliers
150 mm
15cm
6 Inch



06-8624
DUROGRIP
Wire, tightening pliers,
Ligature pliers
150 mm
15cm
6 Inch



06-8625
with serrated jaws
140 mm
14cm
6 Inch



06-8626
one jaw smooth,
one jaw serrated
140 mm
14cm
6 Inch



06-8627
with serrated jaws
06-8628
with longitudinal and
transversal grooves
170 mm / 17cm / 7 Inch



06-8629
190 mm
19cm
7 Inch

Wire Holding forceps, Flat-nosed Pliers,
Pliers for bending and cutting wires



06-8630
130 mm

06-8631
180 mm



06-8630 - 06-8631
Extraction pliers
for boring wires



06-8632
Flat-nosed pliers,
parallel
185 mm
18.5cm
7 Inch

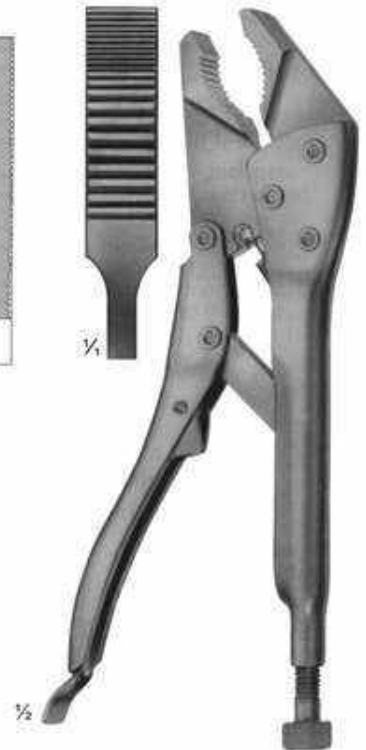

06-8633
Vise grip
200 mm
20cm
8 Inch



06-8634
Round Pliers
180mm
18cm
7 Inch

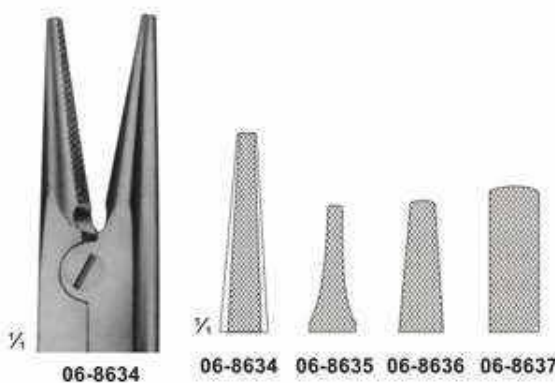

06-8634

06-8634

06-8635

06-8636

06-8637

06-8635 145 mm
06-8636 180 mm
06-8637 180 mm
Extraction pliers for wires



06-8638
Bending pliers
for wires up to
1.8 mm diam.

Wire Cutters and wire Cutting Scissors
DUROTIP with Carbide Cutting Edges



06-8639 ANGLE
130 mm
06-8640 DURTIP
ANGLE
130 mm

for soft wire up to diam.	0,5 mm	0,6 mm
for hard wire up to diam.	0,3 mm	0,4 mm

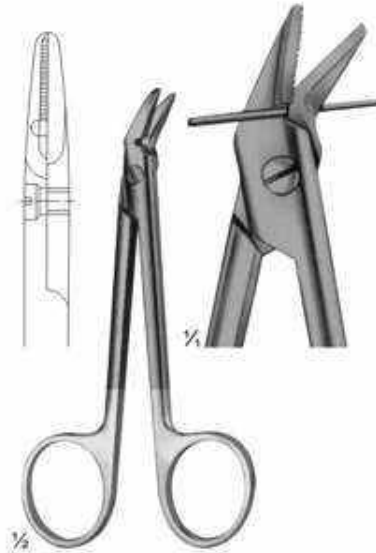

06-8641 120 mm
06-8642 DURTIP
120 mm

for soft wire up to diam.	1,2 mm	1,2 mm
for hard wire up to diam.	0,8 mm	0,8 mm

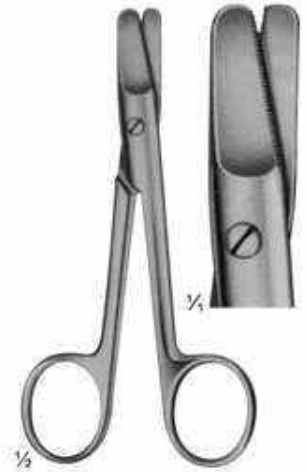

06-8643
HARVEY
125 mm

0,4 mm
0,3 mm



06-8644
150 mm /15cm /7 Inch

for soft wire up to diam	1,5 mm
for hard wire up to diam	1,0 mm



06-8645
160 mm /16cm /7 Inch

1,5 mm
1,2 mm



06-8646
140 mm /14cm /6 Inch
DURTIP
1,5 mm

1,0 mm

Wire Cutting Pliers, Lateral Cutting Action



06-8647
 180 mm / 18cm / 7 Inch

for soft wire up to diam. 2,0 mm
 For hard wire up to diam. 1,5 mm
 specially hardened cutting edges, front and lateral cutting action



06-8648
REILL
 175 mm / 17.5cm / 7 Inch

for soft wire up to diam. 2,0 mm
 For hard wire up to diam. 1,6 mm
 specially hardened cutting edges, for cutting off wires close to the bone



DUROTIP

06-8649
 235 mm
 23.5cm / 9 Inch

for soft wire up to diam. 3,0 mm
 For hard wire up to diam. 2,2 mm

Wire Cutting Pliers, Lateral and Front Cutting Action



06-8650
240 mm
24cm / 7 Inch

for soft wire: up to diam. 2,0 mm
For hard wire: up to diam. 1,6 mm



06-8651
145 mm
14.5cm / 6 Inch

for soft wire: up to diam. 1,5 mm
For hard wire: up to diam. 1,0 mm



06-8652
145 mm
14.5cm / 6 Inch

for soft wire: up to diam. 2,0 mm
For hard wire: up to diam. 1,5 mm

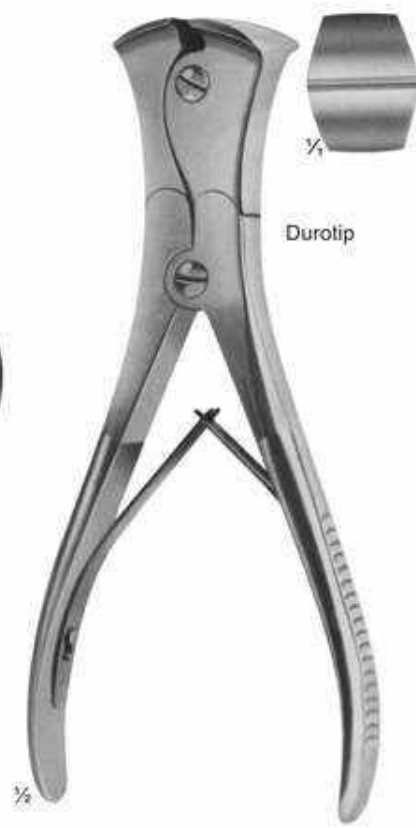

06-8653
220 mm
22cm / 9 Inch

for soft wire: up to diam. 3,5 mm
For hard wire: up to diam. 2,5 mm

Finger Nail Instruments



06-8656
Nail extracting
forceps
135 mm
13cm
5 Inch



06-8657
Nail extracting
forceps
145 mm
14.5cm
6 Inch



06-8658
Finger nail drill
with 3 drill points

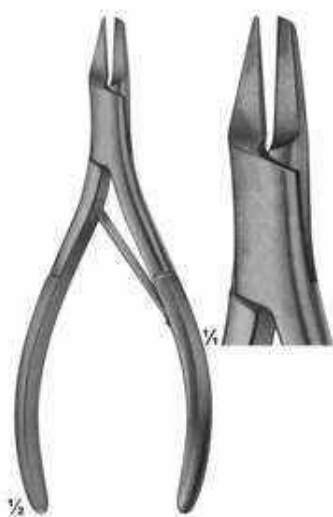

06-8662
Nail splitting
forceps
135 mm
13cm
5 Inch



06-8663
SYSTRUNK
Scissors, for splitting
finger nails
130 mm
13cm
5 Inch



06-8664
Finger ring saw
150 mm / 15cm / 6 Inch

Section - 07



DENTELO SURGICAL[®]
INTERNATIONAL
Serving World of Surgical Since 1996.



Pages 402 - 443

- ★ Plaster instruments
- ★ Suction instruments
- ★ Tungsten carbide Inserts
- ★ Hospital wares

Plaster Instruments

Plaster Knives



with ebony handle

07-9001
HOPKINS
 200 mm
 20cm
 8 Inch



07-9002
ESMARCH
 180 mm
 18cm / 7 Inch

Plaster Saw



07-9003
ENGEL
 160 mm
 16cm
 6 Inch

Bandage and First-Aid scissors



$\frac{1}{2}$
07-9004 - 07-9012 145mm / 14.5cm / 6 Inch

07-9004 black	07-9008 yellow
07-9005 red	07-9009 white
07-9006 blue	07-9010 orange
07-9007 light green	07-9011 violet
	07-9012 bright pink



$\frac{1}{2}$
07-9013 - 07-9021 180mm / 18cm / 7 Inch

07-9013 black	07-9017 yellow
07-9014 red	07-9018 white
07-9015 blue	07-9019 orange
07-9016 light green	07-9020 violet
	07-9021 bright pink

Plaster Scissors

For small plaster dressings



07-9022
 160 mm / 16cm / 6 Inch

1/2



07-9023 - 07-9024
 ESMARCH
07-9023 200mm/20cm / 8 Inch
07-9024 230mm/23cm / 9 Inch

1/2



07-9025
 BERGMANN
 230 mm/23cm / 9 Inch

1/2



07-9026
 BRUNS
 235 mm
 23.5cm
 9 Inch

1/2



07-9027
 235 mm
 23.5cm
 9 Inch

1/2

also to be used as
 bandage scissors



07-9028
 SEUTIN
 230 mm
 23cm
 9 Inch

1/2

also to be used as
 bandage scissors

Plaster Shears

Special features:

The construction of the open jaws avoids tiresome clogging by plaster remnants and allows furthermore an easy cleaning.

The shears do not glide off the plaster owing to the deep teething on the jaws.

The knives with hollow grinding have a better cutting ability and therefore less force is required.

The knives are guided by ball bearings.

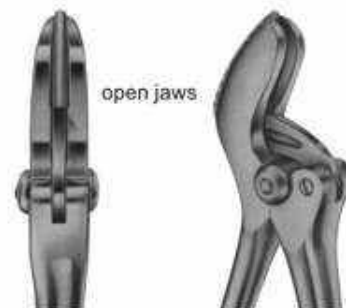

07-9029
 STILLE
 260 mm
 26cm
 10 Inch



07-9030
 STILLE
 360 mm
 36cm
 14 Inch

Plaster Shears

Special features:

The construction of the open jaws avoids tiresome clogging by plaster remnants and allows furthermore an easy cleaning.

The shears do not glide off the plaster owing to the deep teething on the jaws.

The knives with hollow grinding have a better cutting ability and therefore less force is required.

The knives are guided by ball bearings.

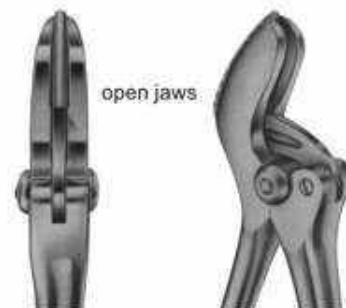

07-9029
 STILLE
 260 mm
 26cm
 10 Inch



07-9030
 STILLE
 360 mm
 36cm
 14 Inch

Plaster Spreader, Plaster Breakers



07-9038
HENNIG
 270 mm
 27cm
 11 Inch



07-9039
MOD. USA
 230 mm
 23cm
 9 Inch



07-9040
WOLFF
 290 mm
 29cm
 11 Inch



with removable jaws



07-9041 - 07-9042
WOLFF
07-9041 180 mm / 18cm / 7 Inch
07-9042 240 mm / 24cm / 9 Inch
 plaster breakers

Suction Instruments

07-9057 150mm

Suction handle, with vacuum regulator and finger cut-off, brass, mirror-finish chromium-plated



olive
Ø 9 mm

07-9058 170mm

Suction handle, with hand regulation valve and quick-shutter, brass, mirror-finish chromium-plated



★ Both suction handles have bayonet fitting Olive and can be used for the suction cannulae. Ø 9 mm



07-9059

Trocar

For puncturing

170 mm / 17cm / 7 Inch



07-9060

Hollow needle, sharp

150 mm / 15cm / 6 Inch



07-9061

double curved

For general surgery

230 mm / 23cm / 9 Inch



07-9062

For tonsillectomy, oral and laryngeal operations

190 mm / 19cm / 7 Inch



07-9063

For tonsillectomy, oral and laryngeal operations

220 mm / 22cm / 9 Inch

★ With bayonet fitting to be used with suction handles (07-9057 - 07-9058)

Suction Instruments

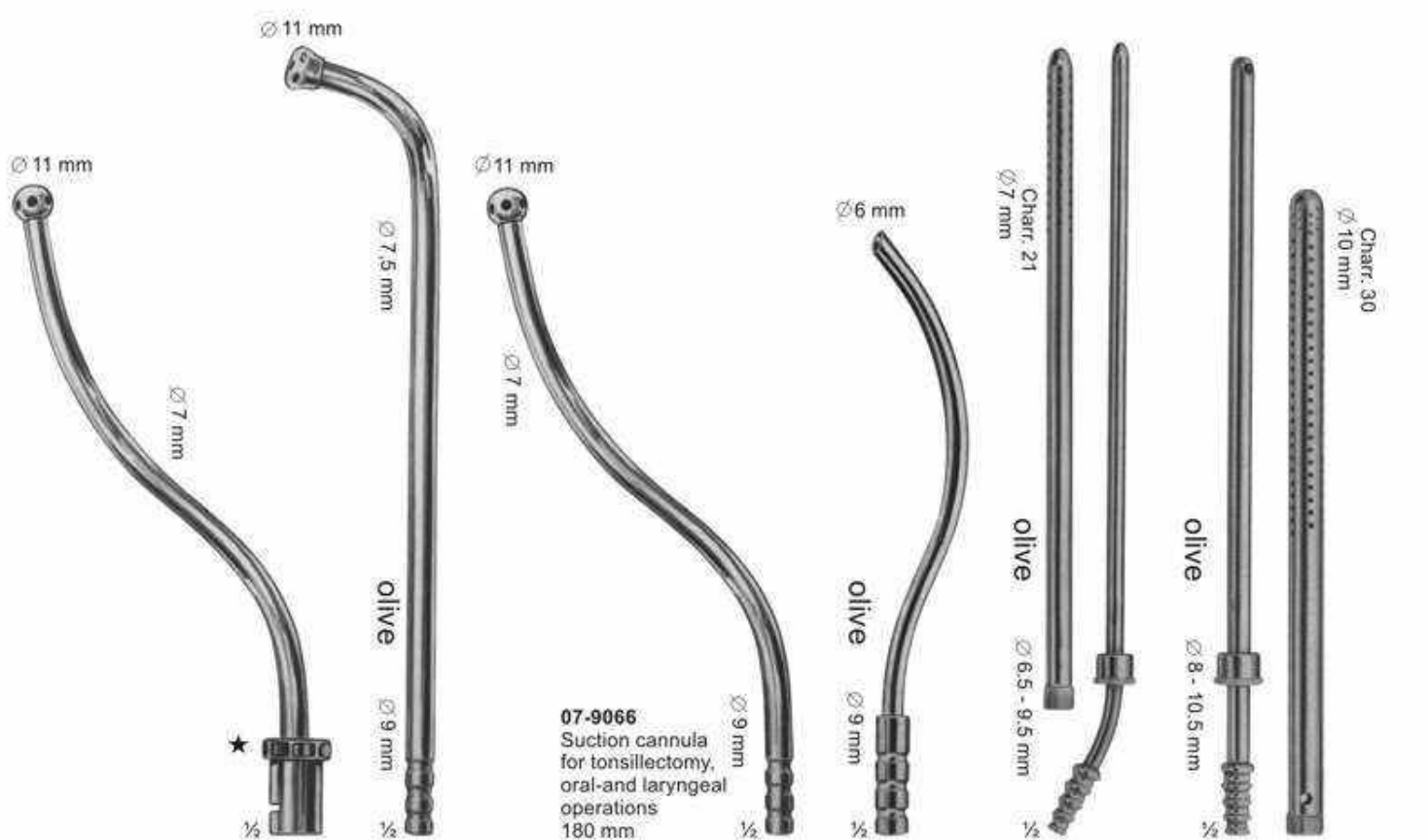

07-9064
For tonsillectomy,
oral and laryngeal
operations
180 mm
18cm
7 Inch

07-9065
Suction cannula
for tonsillectomy,
oral and laryngeal
operations
220 mm
22cm
9 Inch

07-9067
S-shaped blunt cannula
for aspirating fluid from
the excretory ducts of
large glands and for
keeping the operating
area clear
170 mm
17cm
7 Inch

07-9068
POOL
Suction cannula,
with outer tube
to be screwed off
225 mm
22.5cm
9 Inch

07-9069
POOL
Suction cannula,
with outer tube
to be screwed off
225 mm/22.5cm /9 Inch

Suction Instruments

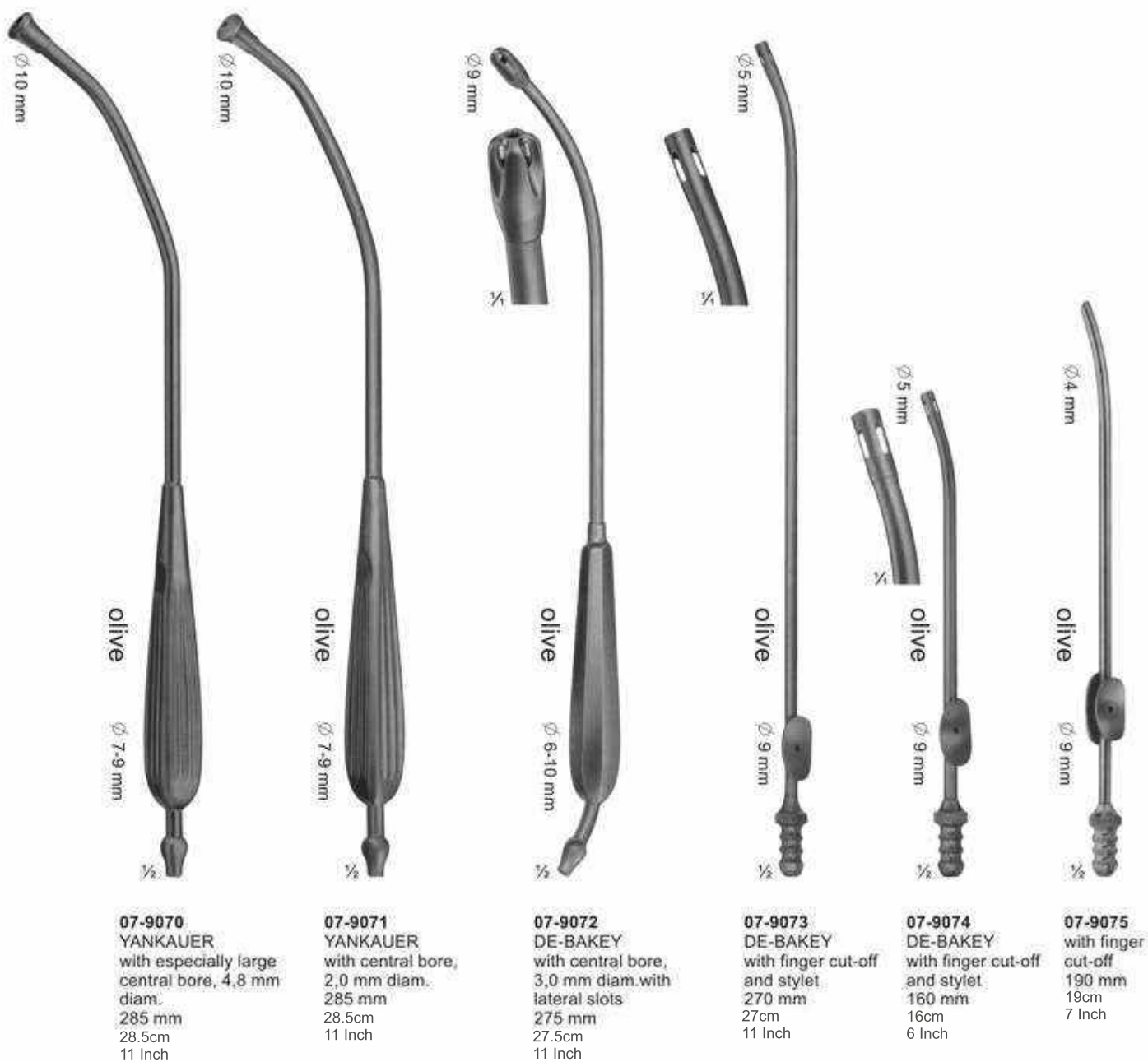

Suction Instruments

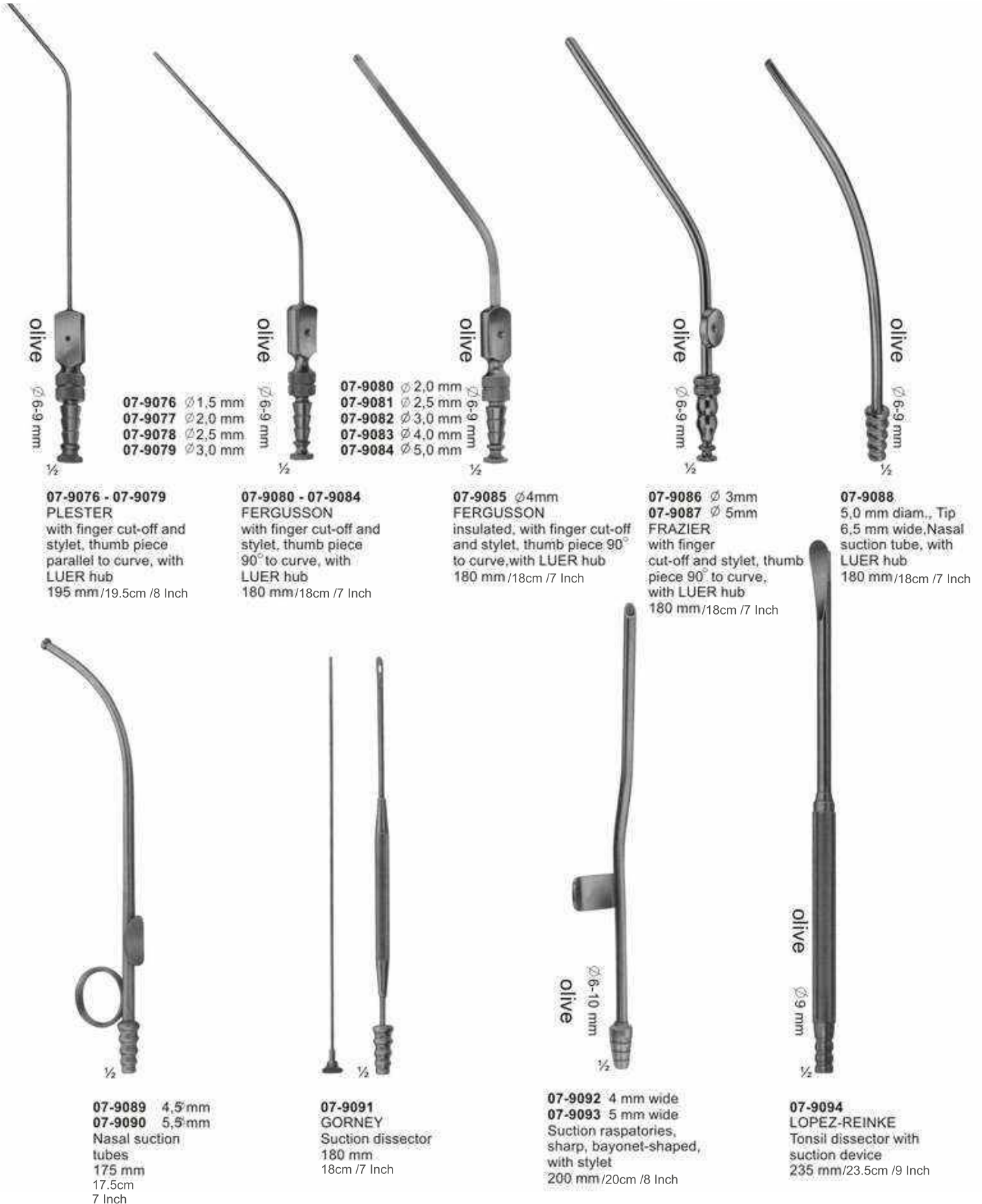

Suction Instruments

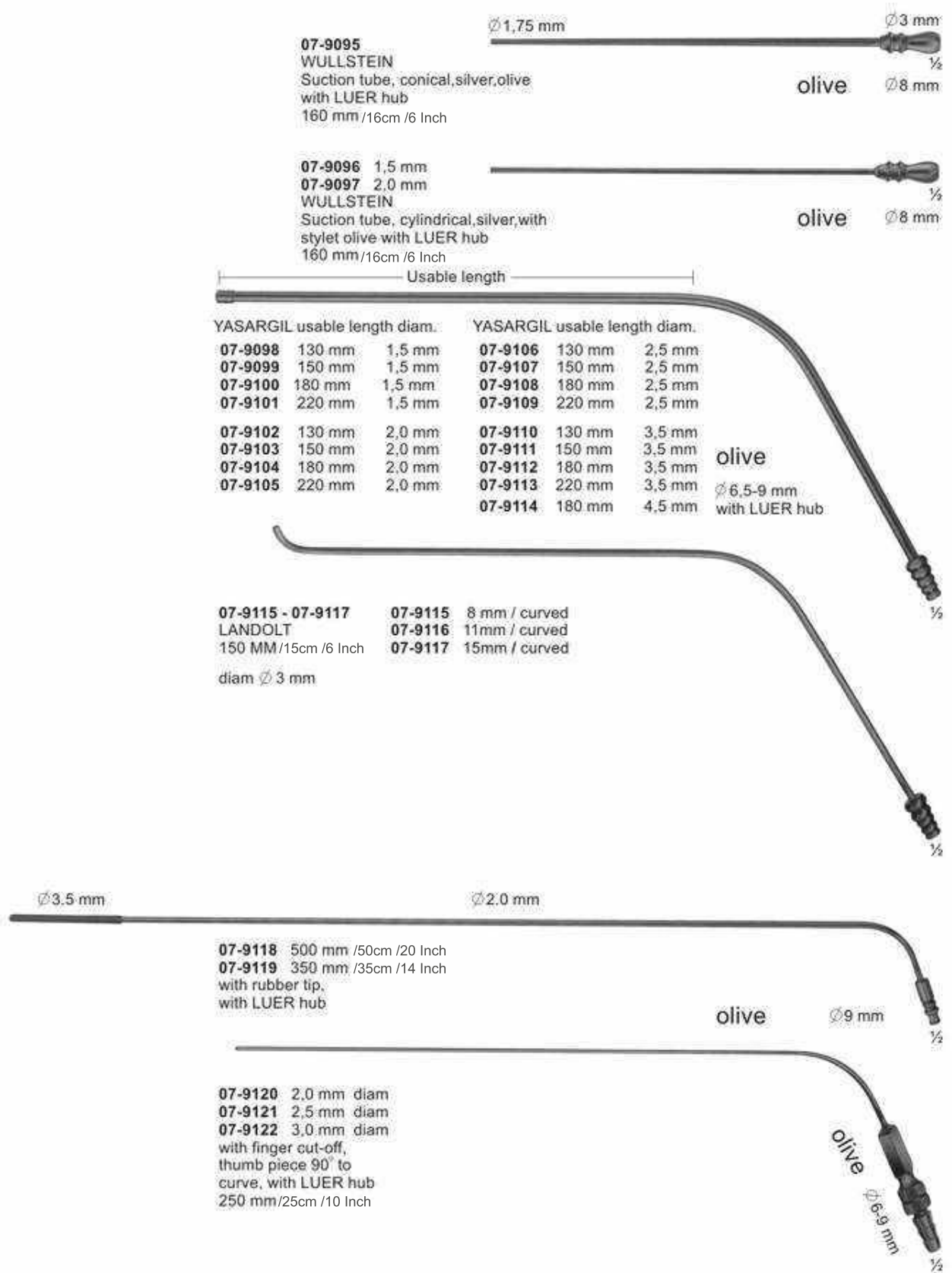

07-9095
WULLSTEIN
 Suction tube, conical, silver, olive
 with LUER hub
 160 mm / 16cm / 6 Inch

Ø 1,75 mm Ø 3 mm
 olive 1/2" Ø 8 mm

07-9096 1,5 mm
07-9097 2,0 mm
WULLSTEIN
 Suction tube, cylindrical, silver, with
 stylet olive with LUER hub
 160 mm / 16cm / 6 Inch

olive 1/2" Ø 8 mm

Usable length

YASARGIL usable length diam.		YASARGIL usable length diam.	
07-9098	130 mm 1,5 mm	07-9106	130 mm 2,5 mm
07-9099	150 mm 1,5 mm	07-9107	150 mm 2,5 mm
07-9100	180 mm 1,5 mm	07-9108	180 mm 2,5 mm
07-9101	220 mm 1,5 mm	07-9109	220 mm 2,5 mm
07-9102	130 mm 2,0 mm	07-9110	130 mm 3,5 mm
07-9103	150 mm 2,0 mm	07-9111	150 mm 3,5 mm
07-9104	180 mm 2,0 mm	07-9112	180 mm 3,5 mm
07-9105	220 mm 2,0 mm	07-9113	220 mm 3,5 mm
		07-9114	180 mm 4,5 mm

olive
 Ø 6,5-9 mm
 with LUER hub

07-9115 - 07-9117 **07-9115** 8 mm / curved
LANDOLT **07-9116** 11mm / curved
 150 MM / 15cm / 6 Inch **07-9117** 15mm / curved

diam Ø 3 mm

Ø 3,5 mm Ø 2,0 mm

07-9118 500 mm / 50cm / 20 Inch
07-9119 350 mm / 35cm / 14 Inch
 with rubber tip,
 with LUER hub

olive Ø 9 mm 1/2"

07-9120 2,0 mm diam
07-9121 2,5 mm diam
07-9122 3,0 mm diam
 with finger cut-off,
 thumb piece 90° to
 curve, with LUER hub
 250 mm / 25cm / 10 Inch

olive Ø 6,9 mm 1/2"

Combined Suction and Irrigation Cannulae, Coagulation Suction Cannulae

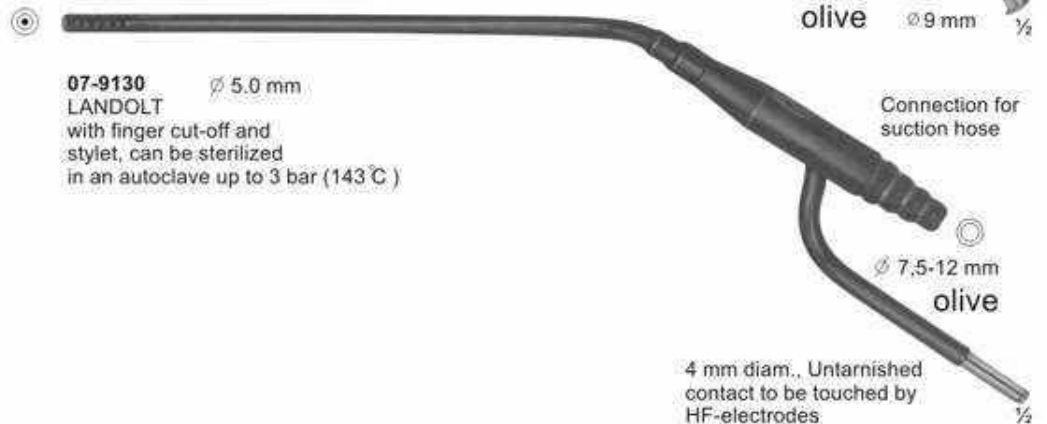

Scissors with Tungsten Carbide Inserts



07-9131 - 07-9133
STANDARD

07-9131 14,5cm
07-9132 16,5cm
07-9133 18,5cm



07-9134 - 07-9136
STANDARD

07-9134 14,5cm
07-9135 16,5cm
07-9136 18,5cm

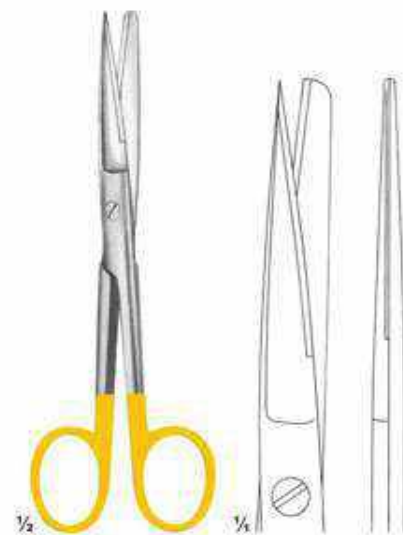

07-9137 - 07-9139
STANDARD

07-9137 14,5cm
07-9138 16,5cm
07-9139 18,5cm



07-9140 - 07-9142
STANDARD

07-9140 14,5cm
07-9141 16,5cm
07-9142 18,5cm

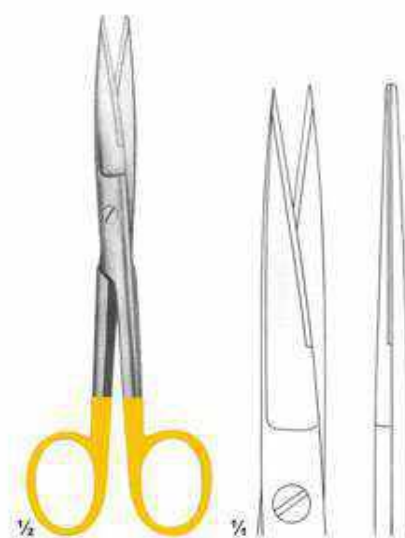

07-9143 - 07-9145
STANDARD

07-9143 14,5cm
07-9144 16,5cm
07-9145 18,5cm



07-9146 - 07-9148
STANDARD

07-9146 14,5cm
07-9147 16,5cm
07-9148 18,5cm

Scissors with Tungsten Carbide Inserts

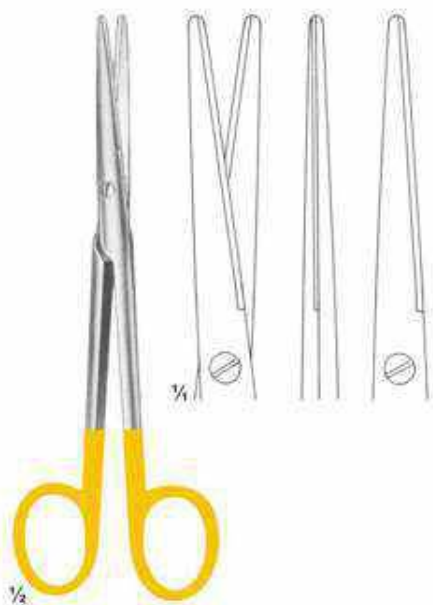

07-9149
MAYO-LEXER
16cm

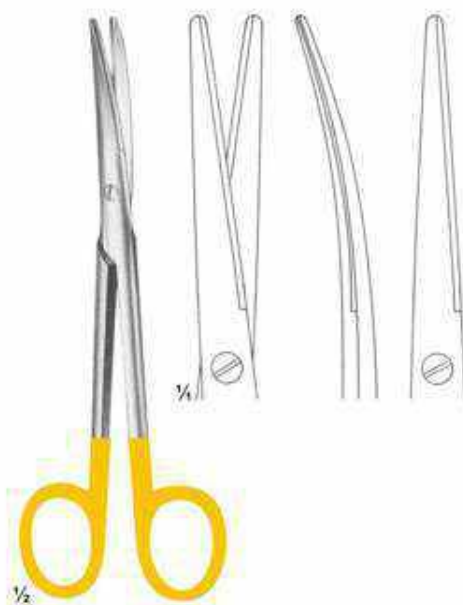

07-9150
MAYO-LEXER
16cm



07-9151 - 07-9152
LEXER

07-9151 16cm
07-9152 21cm

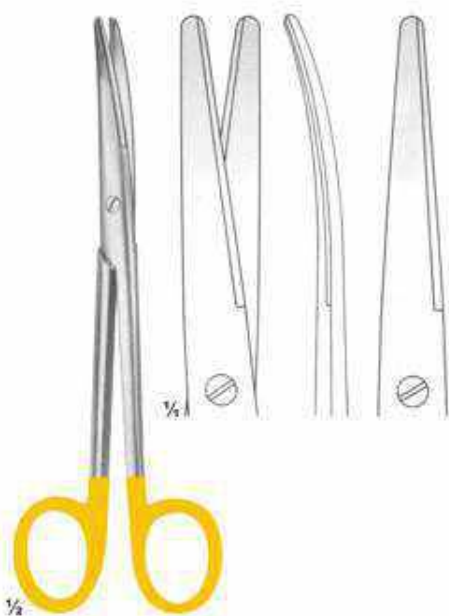

07-9153 - 07-9154
LEXER

07-9153 16cm
07-9154 21cm

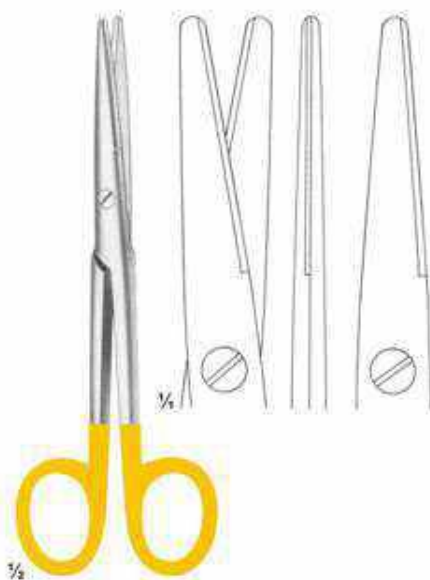

07-9155 - 07-9156
MAYO-STILLE

07-9155 15cm
07-9156 17cm

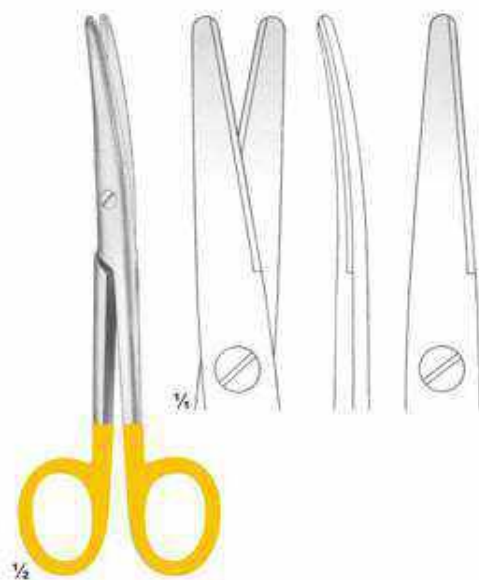

07-9157 - 07-9158
MAYO-STILLE

07-9157 15cm
07-9158 17cm

Scissors with Tungsten Carbide Inserts

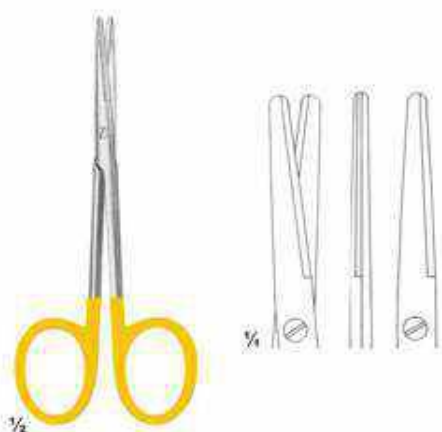

07-9159 - 07-9160
 METZENBAUM

07-9159 11.5cm
 07-9160 14.5cm



07-9161 - 07-9164
 METZENBAUM

07-9161 11.5cm
 07-9162 14.5cm
 07-9163 23cm
 07-9164 25cm



07-9165 - 07-9170
 METZENBAUM

07-9165 18cm
 07-9166 20cm
 07-9167 23.5cm
 07-9168 25.5cm
 07-9169 28cm
 07-9170 30cm



07-9171 - 07-9176
 METZENBAUM-FINO

07-9171 14cm
 07-9172 18cm
 07-9173 20cm
 07-9174 23cm
 07-9175 25cm
 07-9176 28cm

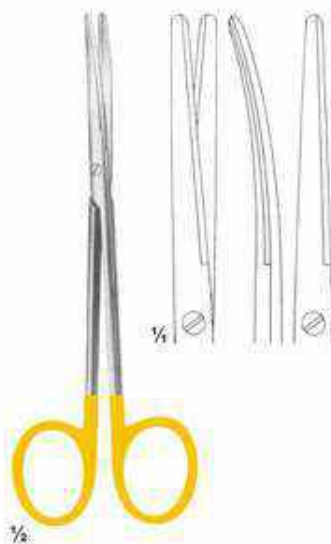

07-9177 - 07-9182
 METZENBAUM-FINO

07-9177 14cm
 07-9178 18cm
 07-9179 20cm
 07-9180 23cm
 07-9181 25cm
 07-9182 28cm

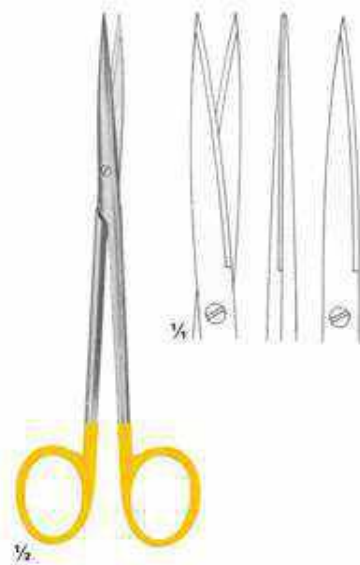

07-9183 - 07-9186
 METZENBAUM-FINO

07-9183 14cm
 07-9184 18cm
 07-9185 20cm
 07-9186 23cm

Scissors with Tungsten Carbide Inserts

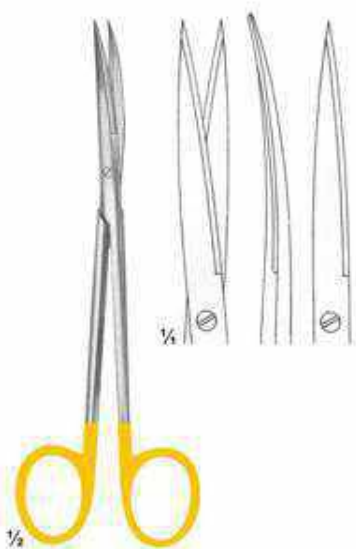

07-9187 - 07-9190
 METZENBAUM-FINO

07-9187 14cm
 07-9188 18cm
 07-9189 20cm
 07-9190 23cm

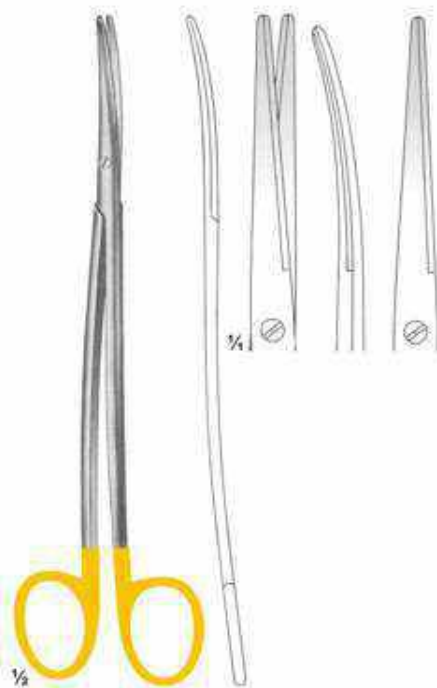

07-9191 - 07-9193
 METZENBAUM-FINO

07-9191 18cm
 07-9192 20cm
 07-9193 23cm

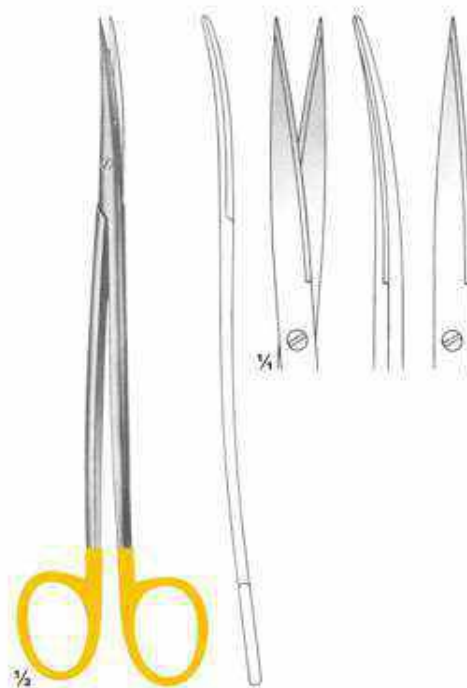

07-9194 - 07-9196
 METZENBAUM-FINO

07-9194 18cm
 07-9195 20cm
 07-9196 23cm

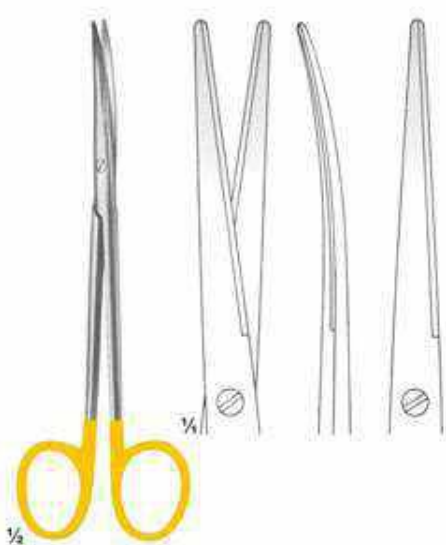

07-9197 - 07-9198
 METZENBAUM

07-9197 20cm
 07-9198 23cm

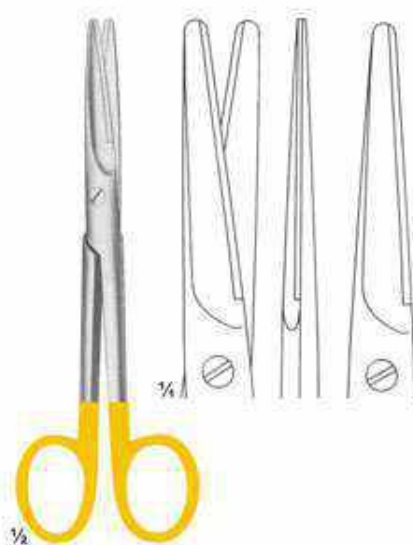

07-9199 - 07-9201
 MAYO

07-9199 14.5cm
 07-9200 17cm
 07-9201 23cm

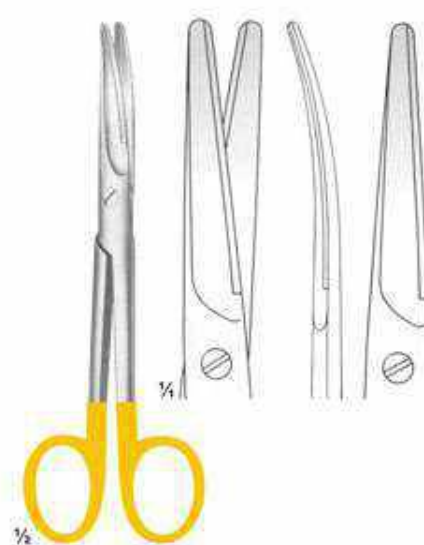

07-9202 - 07-9204
 MAYO

07-9202 14.5cm
 07-9203 17cm
 07-9204 23cm

Scissors with Tungsten Carbide Inserts

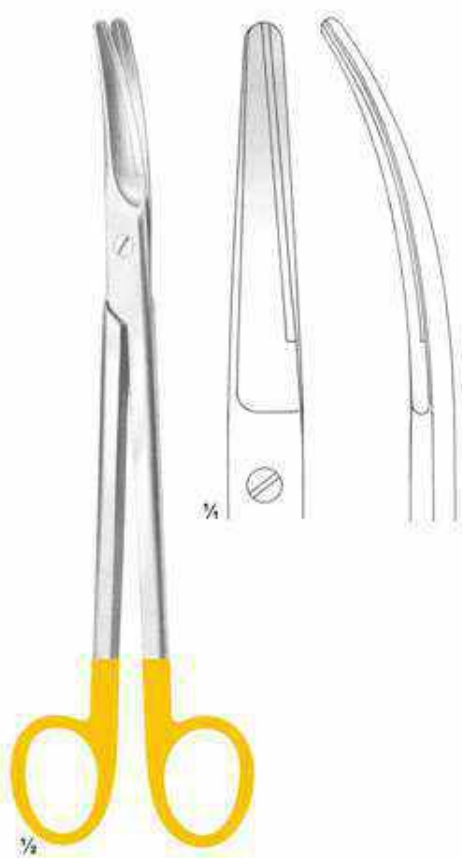

07-9205
WERTHEIM
 Dissecting Scissors
 23cm

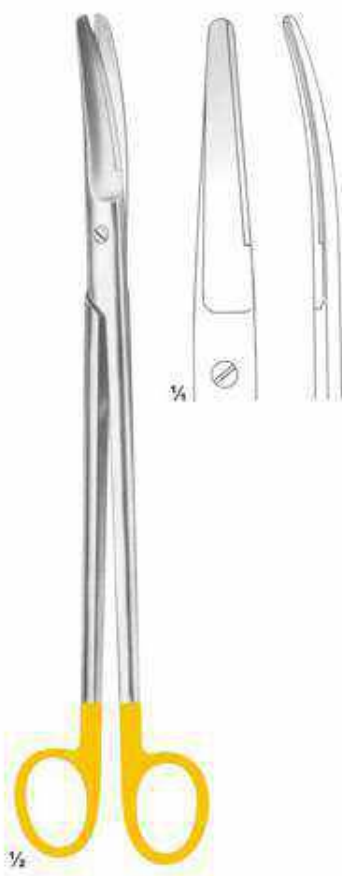

07-9206
SIMS
 20cm
07-9207
 23cm

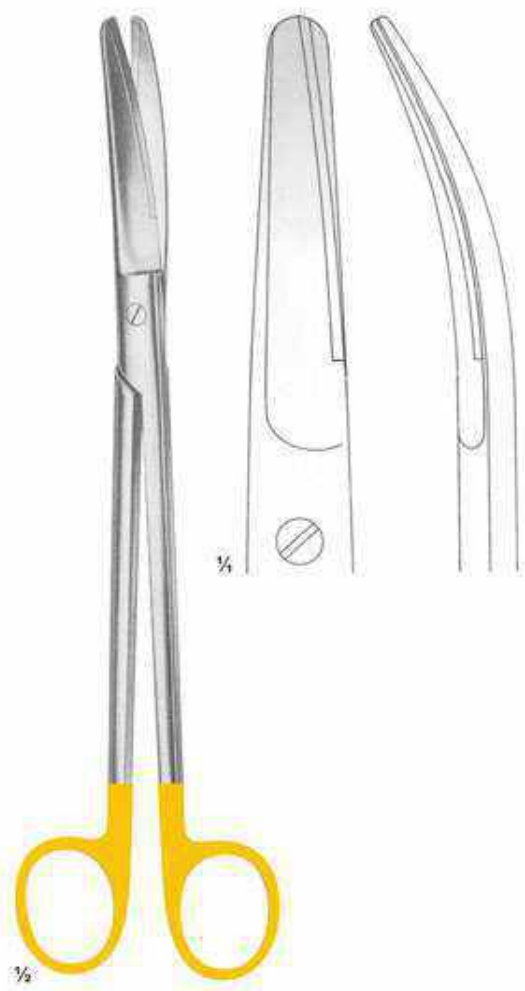

07-9208
MAYO-HARRINGTON
 28cm

Scissors with Tungsten Carbide Inserts



07-9212 - 07-9214	07-9212	19cm	25	07-9215
DE-BAKEY	07-9213	19cm	45	GOLDMANN FOX
(Potts-Smith)	07-9214	19cm	60	13cm

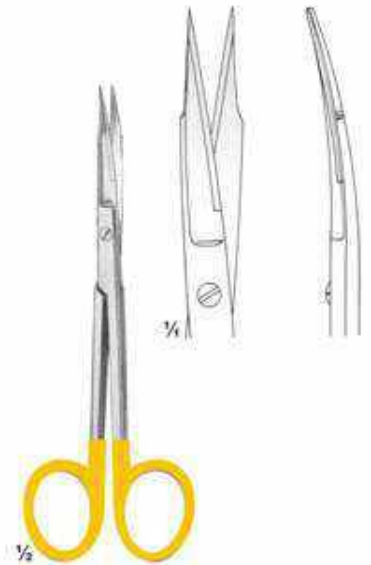
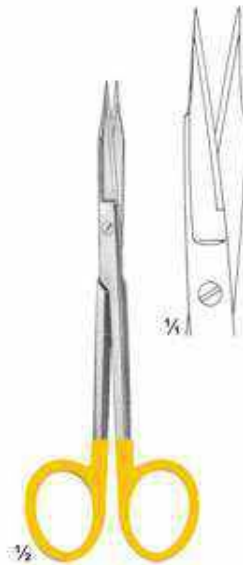

07-9216
GOLDMANN FOX
13cm

07-9209 - 07-9211
DE-BAKEY
(Potts-Smith)

07-9209	23cm	25
07-9210	23cm	45
07-9211	23cm	60

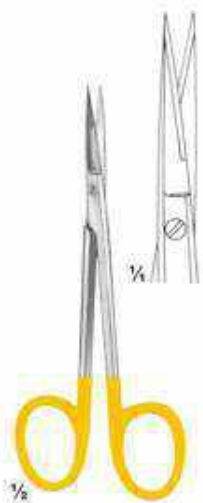

07-9217
Fine Scissor
11,5cm

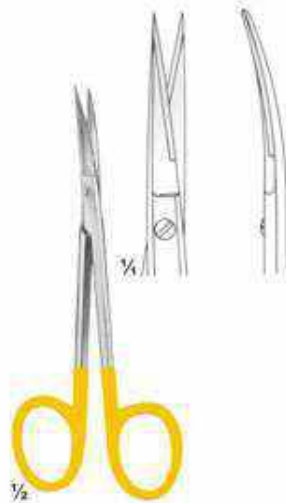

07-9218
Fine Scissor
11,5cm



07-9219
11,5cm

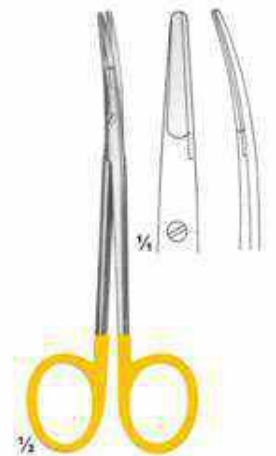

07-9220
RAGNELL (Kilner)
12cm

Scissors & Dissecting Forceps with Tungsten Carbide Inserts

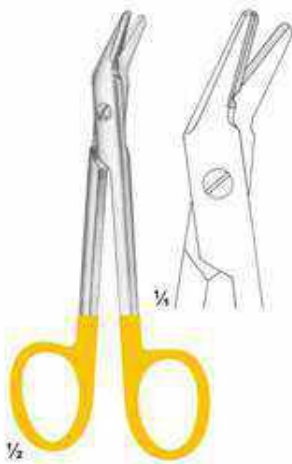

07-9221
UNIVERSAL
12cm



07-9222 - 07-9224
SUTURE SCISSORS
1 Black & 1 Gold Plated ring

07-9222 14cm
07-9223 17cm
07-9224 23cm



07-9225 - 07-9226 **07-9225** 12cm
ADSON **07-9226** 15cm



07-9227
CUSHING
With dissector
end
17.5cm



07-9228
CUSHING
With dissector
end
18cm



07-9229
CUSHING-TAYLOR
18cm



07-9230
DISSECTING FORCEPS
15cm



07-9231
SEMKEN
15cm

Dissecting Forceps and Needle holders with Tungsten Carbide Inserts



07-9232
15cm



07-9233
23cm



07-9234
25cm

07-9232 - 07-9234
WANGENSTEEN

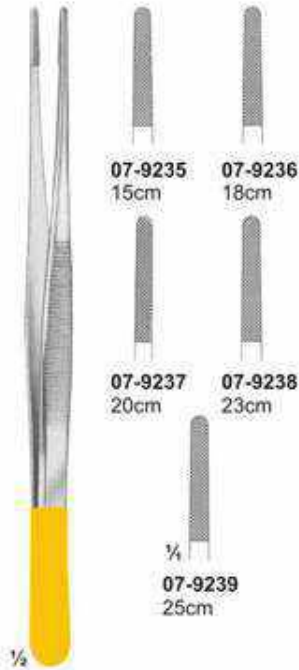

07-9235
15cm

07-9236
18cm



07-9237
20cm

07-9238
23cm

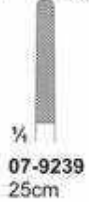

07-9239
25cm

07-9235 - 07-9239
POTTS-SMITH

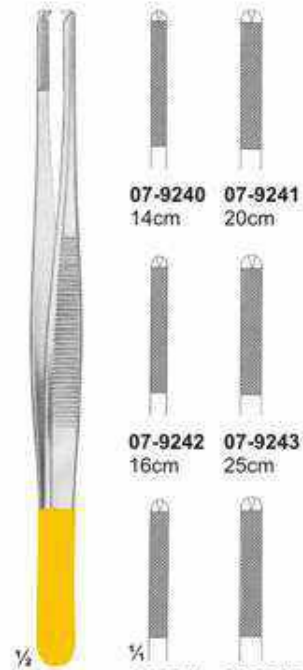

07-9240
14cm

07-9241
20cm



07-9242
16cm

07-9243
25cm

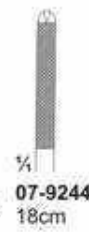

07-9244
18cm

07-9245
30cm

07-9240 - 07-9245
OEHLER



07-9246
POTTS-SMITH
22cm



07-9247
HEPP-SCHIEDEL
18cm



07-9248
CASTROVIEJO
14cm



07-9249
CASTROVIEJO
14cm



07-9250
ARRUGA
16cm

Needle holders with Tungsten Carbide Inserts



07-9251
ARRUGA
16cm



07-9252
CASTROVIEJO
13cm

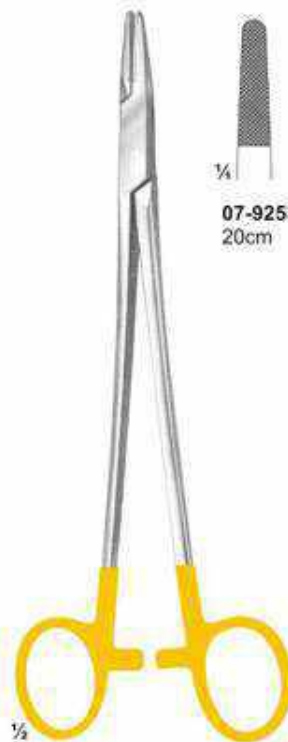

07-9253 07-9254
20cm 24cm

07-9253 - 07-9254
HEGAR

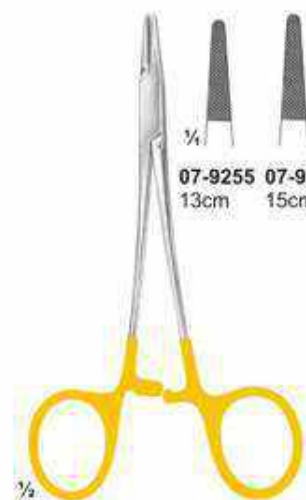

07-9255 07-9256
13cm 15cm

07-9255 - 07-9256
HALSEY



07-9257 07-9258 07-9259
16cm 18cm 20cm

07-9260 07-9261 07-9262
24cm 26cm 30cm

07-9257 - 07-9262
MAYO-HEGAR

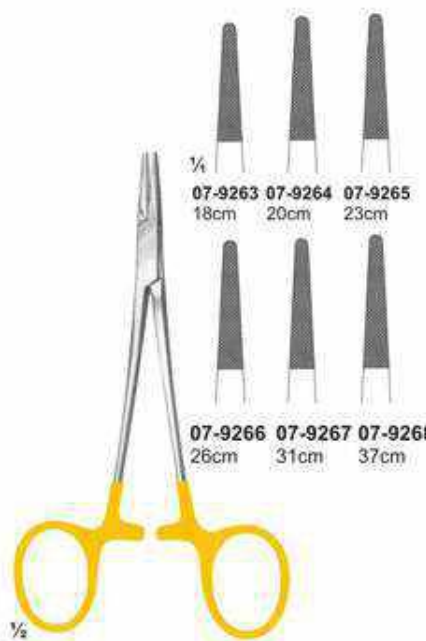

07-9263 07-9264 07-9265
18cm 20cm 23cm

07-9266 07-9267 07-9268
26cm 31cm 37cm

07-9263 - 07-9268
DE-BAKEY



07-9269 07-9270 07-9271 07-9272
14cm 18cm 20cm 23cm

07-9269 - 07-9272
HEGAR-VASCULAR

Needle holders with Tungsten Carbide Inserts

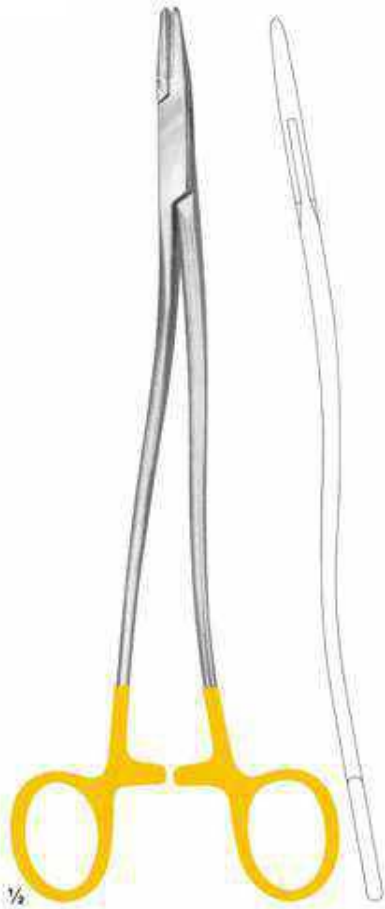

07-9273 - 07-9275
BOZEMANN

07-9273 20cm
07-9274 24cm
07-9275 26cm

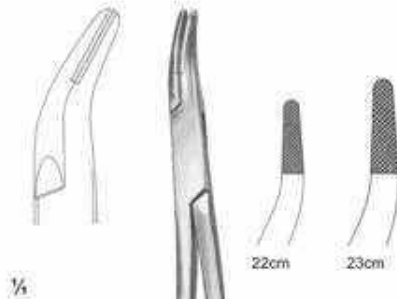

07-9276 - 07-9277 **07-9276** 22cm
STRATTE **07-9277** 23cm



07-9278 - 07-9283
RYDER

07-9278 13cm
07-9279 15cm
07-9280 18cm
07-9281 20cm
07-9282 23cm
07-9283 26cm



07-9284 - 07-9288
RYDER-VASCULAR

07-9284 13cm
07-9285 15cm
07-9286 20cm
07-9287 23cm
07-9288 26cm



07-9289 - 07-9291
MARTIN

07-9289 15cm
07-9290 17cm
07-9291 20cm

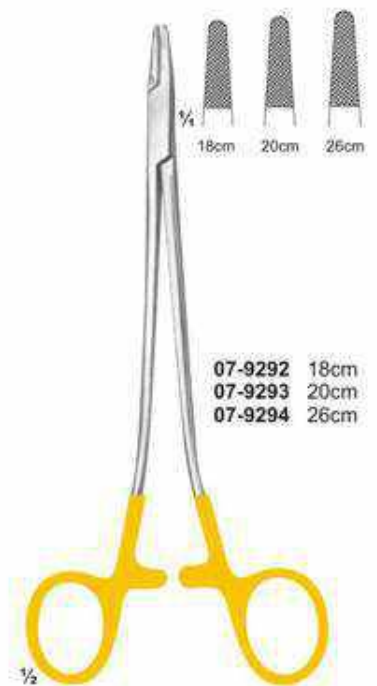

07-9292 - 07-9294
SAROT

07-9292 18cm
07-9293 20cm
07-9294 26cm

Needle holders with Tungsten Carbide Inserts



07-9295
 FINOCHIETTO
 27cm



07-9296 - 07-9297A
 HEANEY
 07-9296 20cm
 07-9297 24cm
 07-9297A 26cm

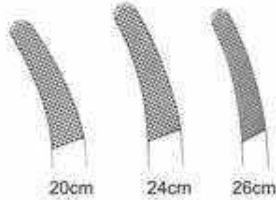

07-9298 - 07-9300
 MATHIEU
 07-9298 14cm
 07-9299 17cm
 07-9300 20cm

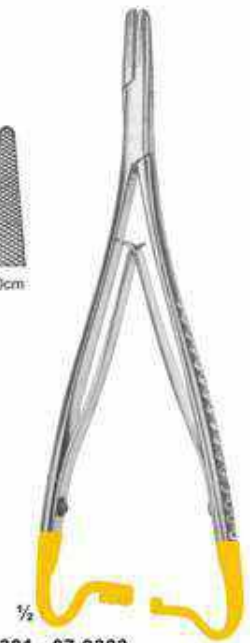
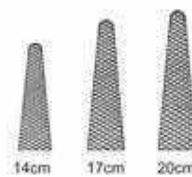

07-9301 - 07-9303
 MATHIEU
 07-9301 17cm
 07-9302 20cm
 07-9303 23cm



07-9304 - 07-9307
 MATHIEU-KOCHER
 07-9304 14cm
 07-9305 17cm
 07-9306 20cm
 07-9307 24cm

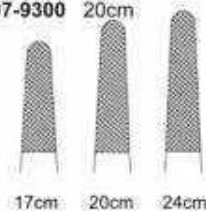

07-9308 - 07-9310
 MATHIEU
 07-9308 17cm
 07-9309 20cm
 07-9310 24cm



07-9311 - 07-9313
 MATHIEU-VASCULAR
 07-9311 17cm
 07-9312 20cm
 07-9313 24cm

Needle holders with Tungsten Carbide Inserts

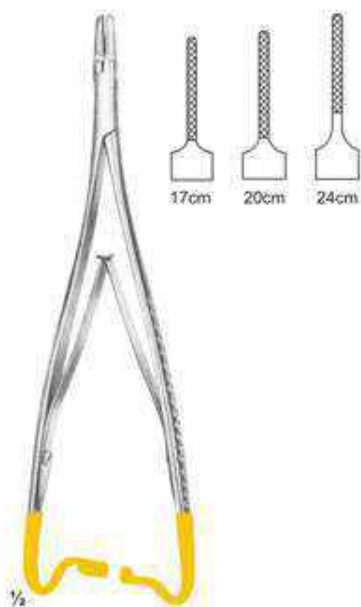

07-9314 - 07-9316
MATHIEU-RYDER
07-9314 17cm
07-9315 20cm
07-9316 24cm



07-9317
LICHTENBERG
20cm



07-9318 - 07-9319
LANGHALS
07-9318 20cm
07-9319 25cm



07-9320 - 07-9321
LICHTENBERG
07-9320 20cm
07-9321 25cm



07-9322 - 07-9323
LUETHY-BECK
07-9322 20cm
07-9323 25cm



07-9324 - 07-9325
LUETHY-BECK
07-9324 20cm
07-9325 25cm



07-9326 - 07-9328
LANGENBECK
07-9326 18cm
07-9327 20cm
07-9328 23cm



07-9329 - 07-9331
LANGENBECK
07-9329 18cm
07-9330 20cm
07-9331 23cm

Needle holders with Tungsten Carbide Inserts and Without TC



07-9332
STEVENS
15 cm



07-9333
KALT
14 cm



07-9334
KALT "HM"
14 cm



07-9335 - 07-9338
CASTROVIEJO
07-9335 14 cm STR.
07-9336 17 cm STR.
07-9337 14 cm CVD
07-9338 17 cm CVD



07-9339 - 07-9340
CASTROVIEJO
07-9339 14 cm
07-9340 17 cm



07-9341
CASTROVIEJO "HM"
13 cm

Needle holders with Tungsten Carbide Inserts and Without TC



07-9342 - 07-9345
CASTROVIEJO "HM"
07-9342 14 cm smooth
07-9343 17 cm smooth
07-9344 14 cm serrated
07-9345 17 cm serrated



07-9346 - 07-9347
CASTROVIEJO-MICRO
14, 5 cm
07-9346 14.5 cm STR
07-9347 14.5 cm CVD



07-9348 - 07-9349
CASTROVIEJO-MICRO
14, 5 cm
07-9348 14.5 cm STR
07-9349 14.5 cm CVD

Ultra Fine:



07-9350 - 07-9351
CASTROVIEJO
(KOSHIMA)
14, 5 cm
07-9350 14.5 cm STR
07-9351 14.5 cm CVD



07-9352 - 07-9353
CASTROVIEJO
(KOSHIMA)
14, 5 cm
07-9352 14.5 cm STR
07-9353 14.5 cm CVD

Needle holders with Tungsten Carbide Inserts and Without TC



07-9354 - 07-9355
BARRAQUER
07-9354 11, 5 cm
07-9355 14 cm



07-9356 - 07-9357
BARRAQUER
07-9356 11, 5 cm
07-9357 14 cm



07-9358 - 07-9359
JACOBSON "HM"
07-9358 18, 5 cm
07-9359 21 cm



07-9360 - 07-9361
JACOBSON "HM"
07-9360 18, 5 cm
07-9361 21 cm



07-9362 - 07-9363
JACOBSON
07-9362 18, 5 cm
07-9363 21 cm



07-9364 - 07-9365
JACOBSON "HM"
18 cm
07-9364 18 cm STR
07-9365 18 cm CVD



07-9366 - 07-9367
JACOBSON "HM"
18 cm
07-9366 18 cm STR
07-9367 18 cm CVD

Micro Needle Holders



07-9368 - 07-9369
 MICRO 2000
 12 cm
07-9368 12 cm STR
07-9369 12 cm CVD



07-9370 - 07-9371
 MICRO 2000
 12 cm
07-9370 12 cm STR
07-9371 12 cm CVD



07-9372
 MICRO 2000
 15 cm



07-9373 - 07-9374
 MICRO 2000
 15 cm
07-9373 15 cm STR
07-9374 15 cm CVD



07-9375 - 07-9376
 YASARGIL
 16 cm
07-9375 16 cm STR
07-9376 16 cm CVD

Wire Cutting Plier With T.C. Inserts



07-9377
TOENNIS
 Elastic pattern for
 dura-or intestinal suture
 180 mm/18cm /7 Inch



07-9378
 Cutting Plier
 12 cm

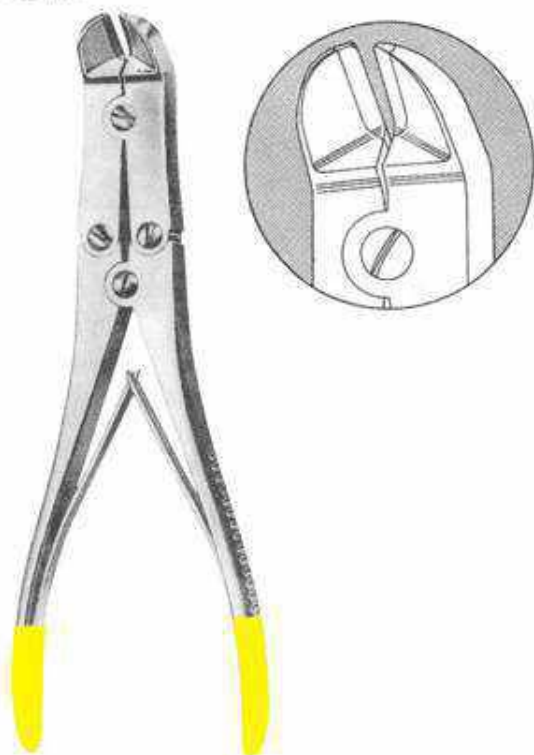

07-9379
MULLAR CLAUS
 22 cm

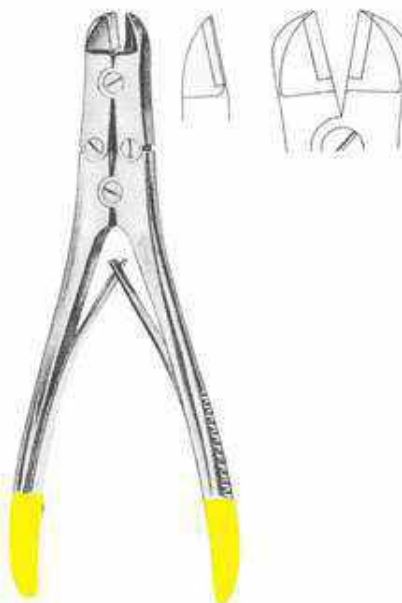

07-9380
 Plier
 17.5 cm

Dressing Sterilizing Drums, Storing Cases and Needle Cases



07-9381 - 07-9395
SCHIMMELBUSCH
without filter laterally
perforated lockable
by sliding mechanism.

	∅ x H sizes in mm
07-9381	80 x 80
07-9382	105 x 120
07-9383	140 x 140
07-9384	160 x 120
07-9385	160 x 150
07-9386	190 x 150
07-9387	190 x 190
07-9388	240 x 160
07-9389	240 x 240
07-9390	290 x 160
07-9391	290 x 240
07-9392	340 x 160
07-9393	340 x 340
07-9394	390 x 190
07-9395	390 x 290



07-9396
BOX
120 x 65 x 13mm
(without Bulldog clamps,
without silicone tape)



07-9397 - 07-9409
KONRICH

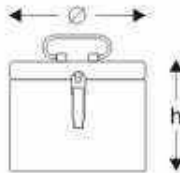

	∅ x H sizes in mm
07-9397	100 x 100
07-9398	150 x 150
07-9399	200 x 150
07-9400	200 x 190
07-9401	240 x 160
07-9402	240 x 230
07-9403	290 x 160
07-9404	290 x 240
07-9405	340 x 160
07-9406	340 x 240
07-9407	390 x 145
07-9408	390 x 240
07-9409	390 x 290



07-9410
Box with support for
needle electrodes,
without instruments



07-9411
50 x 25 x 4,5 mm
07-9412
65 x 42 x 8 mm
07-9413
75 x 25 x 4,5 mm



07-9414
Box with support
120 x 65 x 13 mm
(with bulldog clamps)

07-9415
∅ 62mmx13mm
Interior box
perforated lid
and bottom.



07-9416
complete with perforated
interior box.
∅ 65mm x 15mm

Jars and Instrument boxes



Ø x H	Jar without lid	lid only	lid only with triangle hole
30x90mm	07-9417	07-9426	07-9435
50x100mm	07-9418	07-9427	07-9436
50x130mm	07-9419	07-9428	07-9437
50x175mm	07-9420	07-9429	07-9438
75x100mm	07-9421	07-9430	07-9439
75x130mm	07-9422	07-9431	07-9440
75x175mm	07-9423	07-9432	07-9441
100x175mm	07-9424	07-9433	07-9442
100x200mm	07-9425	07-9434	07-9443

07-9417 - 07-9443



07-9468
205 x 105 x 35 mm

07-9444 - 07-9467

L x B x H		Lid with knob	Lid without knob
07-9444	165 x 85 x 35 mm	07-9452	07-9460
07-9445	200 x 100 x 35 mm	07-9453	07-9461
07-9446	200 x 100 x 50 mm	07-9454	07-9462
07-9447	230 x 130 x 50 mm	07-9455	07-9463
07-9448	260 x 150 x 50 mm	07-9456	07-9464
07-9449	270 x 235 x 50 mm	07-9457	07-9465
07-9450	300 x 200 x 50 mm	07-9458	07-9466
07-9451	325 x 275 x 50 mm	07-9459	07-9467

Dressing Forceps in Jar with Cap



07-9469 - 07-9470

- 07-9469** Sterilizing Forceps
consisting of:
1 Sterilizing Forceps, curved, 25 cm,
without ratchet, with lid for jar
1 jar with wide bottom plate (anti-tilt)
- 07-9470** ditto, with 32 cm long Sterilizing Forceps

Round Metal Boxes, Medicine Cups and Kidney Dishes



Lid with knob

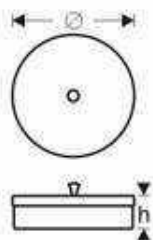

07-9471 - 07-9477

	∅ x H
07-9471	75 x 60 mm
07-9472	75 x 75 mm
07-9473	100 x 60 mm
07-9474	100 x 100 mm
07-9475	125 x 80 mm
07-9476	125 x 125 mm
07-9477	150 x 150 mm



07-9478
25 cc
graduated
inside

07-9479
50 cc
graduated
inside



07-9480
20 cc
Medicine Spoon
graduated
inside



07-9481
∅ 75 x 12 mm
Tablet Tray



07-9482
∅ 90 x 90 mm
Metal Cup



07-9483
∅ 75 x 80 mm
Sputum Cup



Kidney Dish



Lid for kidney dishes

07-9484 - 07-9486

	L x B x H
07-9484	170 x 100 x 35 mm
07-9485	250 x 140 x 40 mm
07-9486	275 x 150 x 45 mm

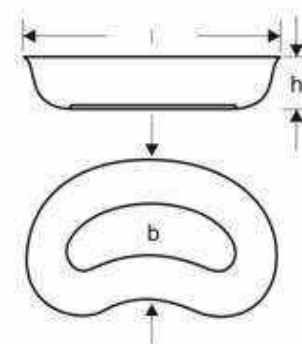

Round Bowls, Graduated Measures and Trays



07-9487 - 07-9494

	∅ x H		
07-9487	40 x 19	mm	0.05L
07-9488	61 x 30	mm	0.07L
07-9489	80 x 40	mm	0.14L
07-9490	116 x 50	mm	0.35L
07-9491	128 x 55	mm	0.45L
07-9492	147 x 65	mm	0.70L
07-9493	167 x 75	mm	1.10L
07-9494	187 x 85	mm	1.60L



07-9495 - 07-9499

	∅ x H		
07-9495	116 x 35	mm	0.30L
07-9496	128 x 38	mm	0.40L
07-9497	147 x 40	mm	0.50L
07-9498	157 x 45	mm	0.75L
07-9499	187 x 45	mm	1.00L



07-9500
∅ 110 x 28 mm 0.15L



07-9501
100 cc = 0.1L
graduated
inside



07-9502 - 07-9505
07-9502 0,25L
07-9503 0,50L
07-9504 1,00L
07-9505 2,00L
graduated
inside



07-9506
235 x 190 x 40 mm



07-9507
∅ 220 x 70 mm

**Powder Strewer, Triangular Basins,
Placenta and Bed Pans**



07-9508
∅ 50 x 100 mm
Powder Pot



07-9509
∅ 50 x 75 mm
Methot With Lid



07-9510
∅ 50 x 75 mm
Methot Without Lid



graduated inside upto 600ml with handle

07-9511



graduated inside upto 600ml

07-9512



07-9513
PLACENTA PAN



07-9514 - 07-9515
BED PAN
07-9514 ∅ 235 mm
07-9515 ∅ 310 mm

Needle Sterilizing Cases



07-9516
Sauerbruch
210 x 125 x 17 mm
perforated lid and
bottom



07-9517
Sauerbruch
210 x 125 x 17 mm
perforated lid and
bottom



07-9518
150 x 95 x 13 mm



07-9519
150 x 95 x 13 mm
perforated lid and
bottom



07-9520
150 x 95 x 13 mm
perforated bottom



07-9521
150 x 95 x 13 mm
perforated lid and
bottom



07-9522
150 x 95 x 13 mm



07-9523
150 x 95 x 13 mm
perforated lid and
bottom



07-9524
150 x 95 x 11 mm
Needle tray perforated
bottom

Storing Cases Perforated Bottom with Textile Filter



07-9525
Deponette
245 x 135 x 35mm

Perforated bottom,
with textile filter ref.



07-9526
Deponette
245 x 135 x 50mm

Perforated bottom,
with textile filter ref.



07-9527
Deponette
245 x 135 x 60mm

Perforated bottom,
with textile filter ref.



Perforated Bottom

Universal Trays and Storing Cases



07-9528 - 07-9532

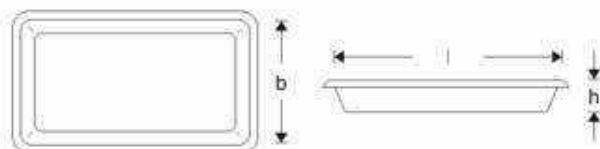

satın finish	size in mm l x b x h
07-9528	230 x 165 x 30
07-9529	300 x 155 x 30
07-9530	300 x 175 x 40
07-9531	350 x 240 x 36
07-9532	400 x 300 x 50



07-9533 - 07-9539

satın finish	size in mm Ø x H
07-9533	210 x 160 x 10
07-9534	240 x 180 x 10
07-9535	310 x 150 x 10
07-9536	310 x 210 x 10
07-9537	350 x 240 x 10
07-9538	400 x 270 x 20
07-9539	420 x 280 x 10



07-9540 - 07-9550

	L x H x B	mm
07-9540	230 x 130 x 50	mm
07-9541	260 x 150 x 50	mm
07-9542	275 x 235 x 50	mm
07-9543	300 x 200 x 50	mm
07-9544	325 x 275 x 50	mm
07-9545	420 x 175 x 50	mm
07-9546	230 x 130 x 75	mm
07-9547	260 x 150 x 75	mm
07-9548	300 x 200 x 75	mm
07-9549	325 x 275 x 75	mm
07-9550	420 x 175 x 75	mm

Sterilizing Baskets / Trays

Sterilizing tray of wire mesh
 for container 30cm long



07-9553
 250 x 250 x 50mm

07-9551 480 x 250 x 50 mm
07-9552 520 x 250 x 75 mm
07-9553 520 x 250 x 100 mm
 Sterilizing Trays of wire mesh
 for container 60cm long.

07-9551 - 07-9553



Sterilizing tray of perforated steel sheet

07-9554 - 07-9559

07-9554 240 x 240 x 50 mm
07-9555 240 x 240 x 80 mm
07-9556 240 x 240 x 100 mm
07-9557 480 x 260 x 50 mm
07-9558 520 x 260 x 80 mm
07-9559 520 x 260 x 100 mm

Sterilizing Basket

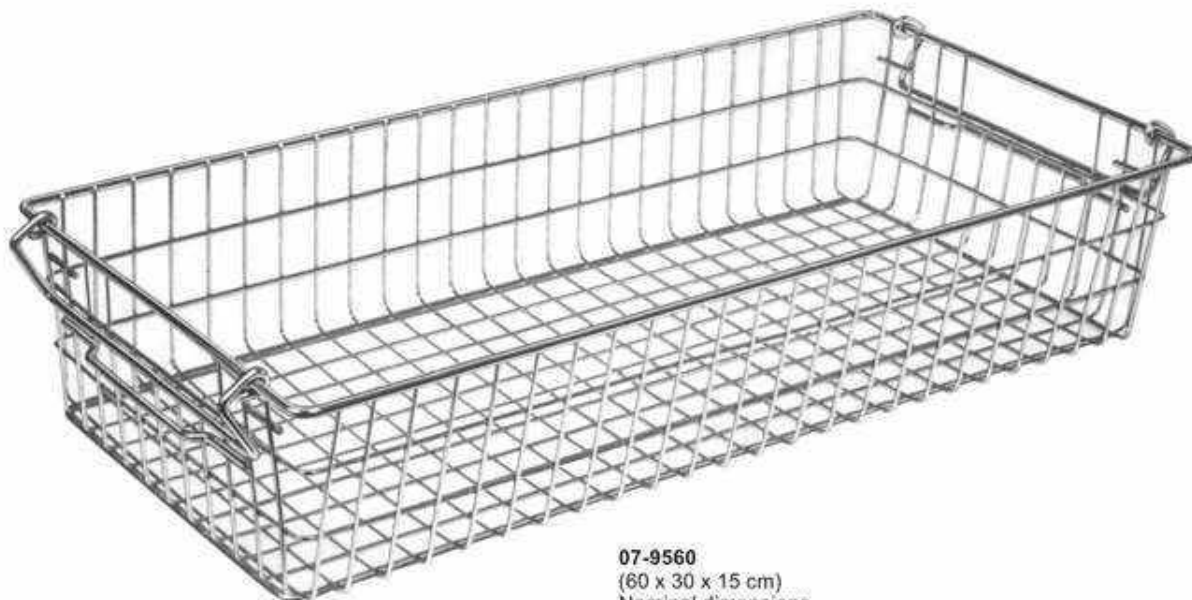

07-9560
(60 x 30 x 15 cm)
Nominal dimensions



07-9561
(60 x 30 x 30 cm)
Nominal dimensions



DENTELO SURGICAL[®] INTERNATIONAL

Serving World of Surgical Since 1996.

Manufacturers & Exporters of All Kind of Surgical & Dental Instruments.

25 YEARS
EXCELLENCE



OFFICE ADDRESS:

- ✉ zubair@dentelosurgical.com, info@dentelosurgical.com
- 🌐 www.dentelosurgical.com
- ☎ 0092 340 6200149
- 📍 Islam Nager, Pacca Garha
Sialkot 51310
Pakistan

